



# 2023 CATALOG



Photo: Lucio Buselli - Overlook Farm

**BUSINESS UNIT GET**

Via delle Albere 12,  
36045 Alonte – Vicenza (Italy)  
Phone: +39 0444 727272  
Fax: +39 0444 727292  
Email: [sales.get@athena.eu](mailto:sales.get@athena.eu)  
Website: [athena.eu](http://athena.eu)  
AthenaMotorsport    
[getdatait](http://getdatait) 



# INDEX

## OFF-ROAD ENGINE CONTROL

- 10 **MOTOCROSS**
- 14 CDI 2-STROKE
- 16 RX1 PRO
- 18 RX1 PRO TUNER
- 20 PRO FACTORY KIT
  
- 22 **ENDURO**
- 24 ECULMB 2-STROKE EFI RACE KIT
- 28 ECULMB
- 30 RX1 PRO - ENDURO
  
- 32 **ATV**
- 34 ECULMB 4 STROKE
  
- 36 **OFFROAD ECUs & CDI's CONVERSION CHARTS**
  
- 40 **OFFROAD ECU ACCESSORIES**
- 44 LC-GPA
- 46 GPA SWITCH
- 48 WIFI-COM
- 50 2ND INJECTOR KIT

## ROAD ENGINE CONTROL

- 52 **ENGINE CONTROL UNITS**
- 56 ECULMB FOR YAMAHA R3/R25
- 58 ECUJ5 FOR KTM DUKE/RC
- 60 GP2 POWER FOR YAMAHA T-MAX
- 62 GP2 EVO FOR YAMAHA T-MAX
- 64 KM3 EVO FOR HONDA NSF 250R
  
- 66 **ECU ACCESSORIES**
- 68 WIFI-COM
- 70 D30 EVO
- 71 QUICKSHIFTER
- 71 MAP SWITCH

## SOFTWARE AND PROGRAMMING

- 72 PROGRAMMING TOOLS

## DATA ACQUISITION

- 78 SL1 SMART LOGGER
- 80 WINTAX4 GET USER
- 82 MAGNETOSTRICTIVE SENSOR
- 83 LC1-PRO LAMBDA

## SMART TOOLS

- 86 RPM DASH
- 90 SMART SOS
- 92 HOUR METER
- 94 WIFI-COM HONDA CRF

## POWER TOOLS

- 98 LITHIUM BATTERIES
- 102 BATTERY CHARGER
- 104 JUMPSTARTER MINI

**NEW 2023**  
**GET MERCH**  
P.106

# THANKS FOR YOUR EXPERIENCE

## GRAZIE PER LA VOSTRA ESPERIENZA

GET has been supporting the best Teams and Riders for many years in the major and most important competitions including **AMA Supercross Championship, FIM MXGP and EMX Championships, FIM World and Italian Enduro Championships.**

A continuous search for performance improvement and constant cooperation with professionals, allow GET to be a reference in the world of Racing and of the two wheels.

GET da anni supporta i migliori Team e Piloti nelle maggiori e più importanti competizioni del settore tra cui **AMA Supercross, i Campionati Mondiale ed Europeo FIM Motocross, i Campionati Mondiale e Italiano FIM Enduro.**

La continua ricerca per il miglioramento delle performances ed il periodico confronto con i professionisti del settore, permette a GET di essere un punto di riferimento nel mondo del Racing e delle due ruote.

## FIM MXGP WORLD CHAMPIONSHIP

### SUPPORTED TEAMS

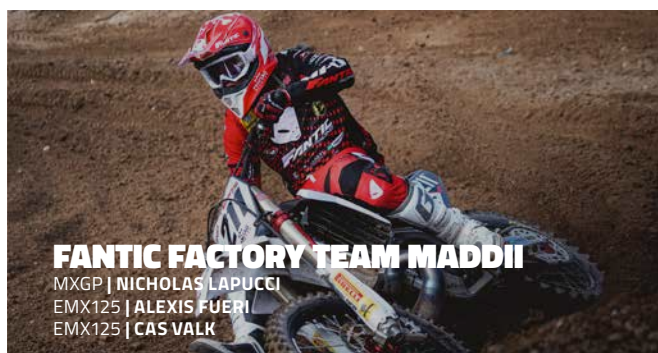
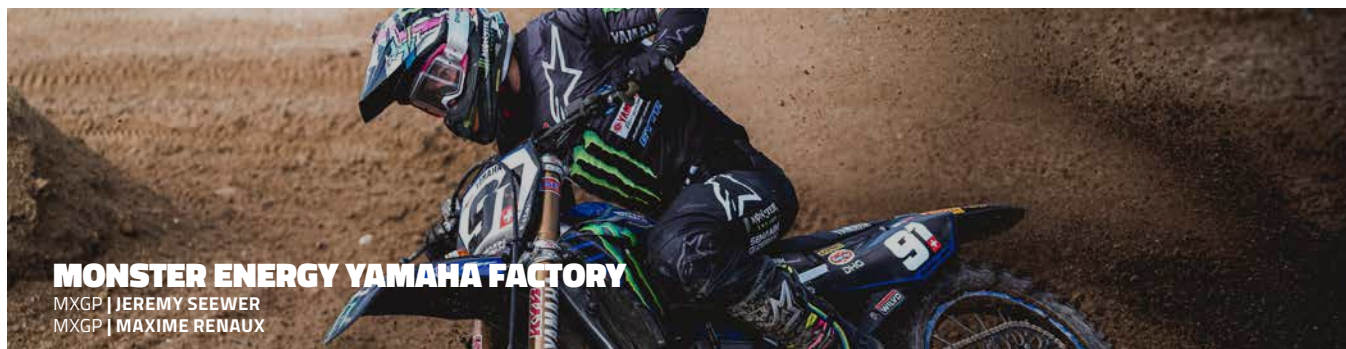

# FIM MXGP WORLD CHAMPIONSHIP

## SUPPORTED TEAMS



**HITACHI KTM BY MILWAUKEE**  
 MX2 | ISAK GIFTING  
 MX2 | HAY KARSSEMAKERS



**MRT RACING TEAM KTM**  
 EMX250 | VALERIO LATA  
 MXGP | MICHELE CERVELLIN



**BETA - SDM CORSE MX TEAM**  
 MXGP | ALESSANDRO LUPINO



**KROSTEAM-LUNARDI RACING**  
 EMX250 | DAVIDE DE BORTOLI

# ITALIAN AND WORLD ENDURO CHAMPIONSHIP

## SUPPORTED TEAMS



**FANTIC D'ARPA RACING TEAM**  
 JED ETCHELLS  
 ALBIN MORRBIN  
 PYYR JUUPALUOMA  
 DANIEL MILNER



**FANTIC FACTORY TEAM E50 RACING**  
 LOIC LARRIEU  
 DAVIDE GUARNIERI  
 EMANUELE FACCHETTI  
 DANIELE DEL BONO



**ESBK - PREMOTO3, MOTO 4**  
**FEDERATION PARTNERSHIP**



**FSBK OGP - PREMOTO3**  
**FEDERATION PARTNERSHIP**



# WHO WE ARE

**CHI SIAMO**



DISCOVER MORE  
SCOPRI DI PIÙ

GET is the brand which identifies the electronic division of Athena Group. Leading manufacturer of aftermarket Engine Control Units and data acquisition systems for 2,3 and 4-wheels vehicles, it is also strongly involved in the OEM market offering a complete service of design and development. Furthermore, GET recently launched a new range of smart devices as hour meters, batteries and chargers.

The internal team of engineers and technicians is rich in experience and ideas and offer customers state-of-the-art solutions and operative platforms to work efficiently and to be competitive in the marketplace. GET team provides both software and hardware products, vehicle testing and analysis, technical consultancy and training sessions.



GET è il brand che identifica la divisione elettronica del Gruppo Athena. Produttore leader di centraline elettroniche aftermarket e sistemi di acquisizione dati per veicoli a 2, 3 e 4 ruote, GET offre anche un servizio completo di progettazione e sviluppo per i primi equipaggiamenti e una serie di nuovi accessori elettronici come batterie, caricatori e contaore.

Il team GET è formato da ingegneri e progettisti ricchi di esperienza e idee. Il loro obiettivo è offrire la propria conoscenza dando ai clienti soluzioni e basi per lavorare ed essere sempre competitivi ed aggiornati nel mercato. Il Team GET fornisce prodotti software e hardware, analisi e test veicoli, consulenza tecnica e training formativi.

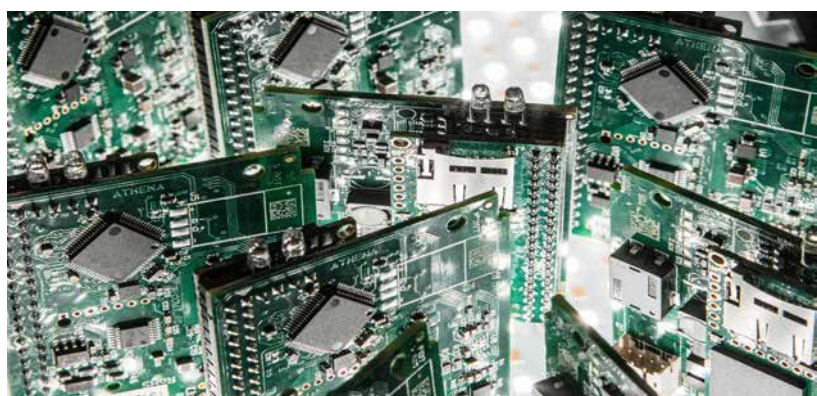

# GET MAIN TECHNOLOGIES

## PRINCIPALI TECNOLOGIE GET

- GET plant has several engine testing rooms to carry out all tests required for vehicles homologation, plus a climate chamber for low temperature starting strategies developments. GET also carries out tests to analyze exhaust gas emissions and to offer a full-service package from vehicle developing to the final approval test in order to meet all the motorcycles regulations
- Thanks to the WiFi-COM technology, every user can connect with a GET ECU by using the free WiGET app.

The app represents the quickest way to modify some of the engine parameters on the map and is also an intuitive diagnostic tool. It is available for the most common smartphones and tablets and avoids the purchase of other expensive software.

- GET has developed and patented a unique power control system called GPA (GET Power Assistance) which works as a traction control without any additional sensors. GPA manages and delivers the right power required in that specific condition in order to guarantee a safer ride whilst maintaining maximum performance.

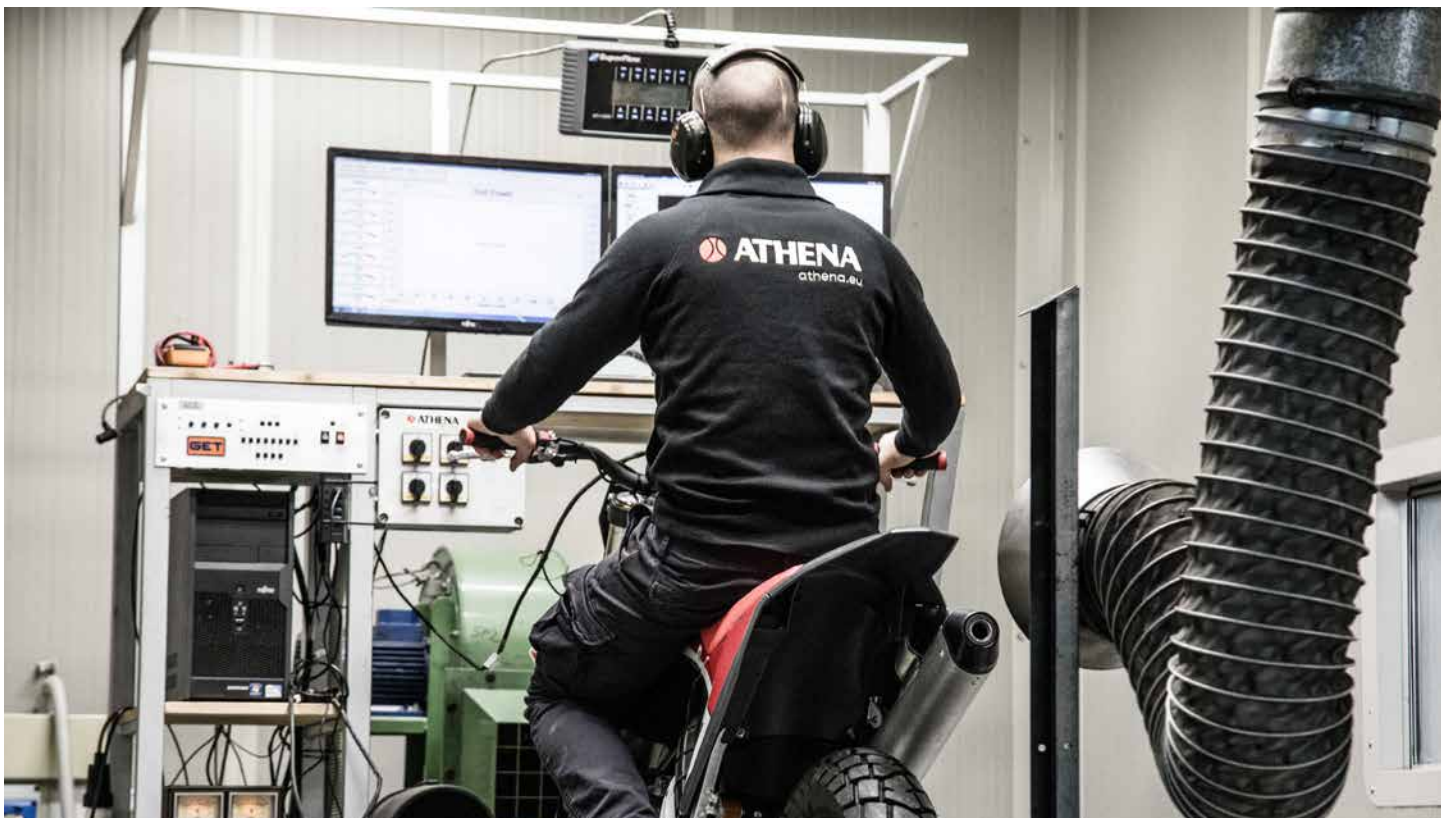

- Lo stabilimento GET ha a disposizione laboratori qualità e diversi banchi prova per condurre tutti i test necessari alla configurazione dei veicoli, inclusa una cella climatica per prove di avviamento a bassa temperatura. GET può condurre inoltre test per analizzare le emissioni dei gas di scarico e offrire un servizio completo dallo sviluppo dei veicoli alla loro omologazione.
- Grazie alla tecnologia WiFi-COM, ogni utente può connettersi ad una centralina GET, utilizzando l'App gratuita WiGET. Questa applicazione rappresenta il modo più veloce per modificare alcuni parametri della mappatura ed è uno strumento intuitivo di diagnostica utilizzabile con dispositivi quali smartphone e tablet, evitando l'acquisto di software costosi.
- GET ha sviluppato e brevettato un esclusivo sistema di controllo di potenza per il mondo off-road chiamato GPA (GET Power Assistance), che lavora come una sorta di Traction Control ma senza utilizzare sensori esterni. GPA è in grado di gestire il corretto flusso di potenza richiesto, al fine di garantire condizioni di guida sicure, mantenendo, allo stesso tempo, massime prestazioni.





## AREA DOWNLOAD

Discover the new Download Area, the simple and intuitive tool that Athena Group has developed for B2B customers. Visit **download.athena.eu**, enter your login credentials for the e-commerce [www.athena.eu](http://www.athena.eu) and browse the various sections to identify the contents to view and download.

Scopri la nuova Area Download, lo strumento semplice e intuitivo che il Gruppo Athena ha realizzato per i clienti B2B. Vai su **download.athena.eu** inserisci le tue credenziali di accesso per l'e-commerce [www.athena.eu](http://www.athena.eu) e naviga nelle varie sezioni per identificare i contenuti da visualizzare e scaricare.

GO TO DOWNLOAD AREA  
VAI ALL'AREA DOWNLOAD



### Marketing Tools:

Product images, catalogues, technical sheet, product copy, applications;  
Immagini di prodotto, cataloghi, schede tecniche, copy di prodotto, applicazioni;

### Application Maps:

Maps developed by GET technicians and control units' firmware always up-to-date;  
Mappe sviluppate dai tecnici GET e firmware centralina sempre aggiornati;

### Product Files:

Complete list of part numbers with packaging data, stock availability, EAN/UPC code, and price.  
Lista di tutti i codici con dati di confezionamento, stock disponibile, EAN o codice UPC e prezzo.

## LANDING PAGES

Find out on our [athena.eu](http://athena.eu) website's home page the landing pages we have built to provide information and to deepen the technical and functional aspects of our range! Browse through photos, videos and insights to understand the innovation of GET products, or download the manuals that are always updated and at your disposal.

Scopri nell'home page del nostro sito [athena.eu](http://athena.eu) le landing pages che abbiamo ideato per fornire informazioni e vedere nel dettaglio gli aspetti tecnici e di funzionamento della nostra gamma! Naviga fra foto, video e approfondimenti per capire l'innovazione dei prodotti GET, oppure scarica i manuali sempre aggiornati e a tua disposizione.

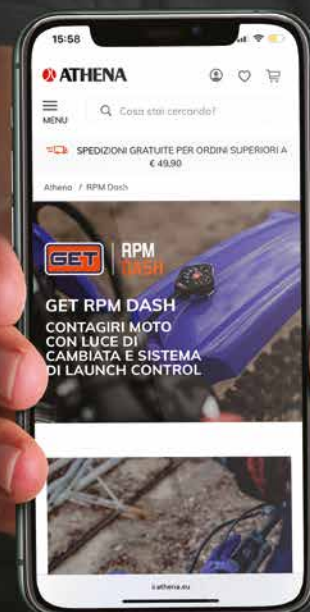

## NEW PACKAGING



### + GREEN

Removal of plastic and paper lamination.  
Eliminazione plastica e plastificazioni.



### + ORGANIZED

New housing designed to protect the products and to better organise accessories and cables.  
Nuovi alloggi studiati per proteggere i prodotti e organizzare accessori e caverteria.



### + SMART

Dimensions optimization for an improved management of shipments to customers.  
Ottimizzazione delle misure, per gestire al meglio le spedizioni verso i clienti.



### + ECOFRIENDLY

QR code with a direct link to the landing page which collects all product manuals so as to further reduce paper consumption.  
QR code che rimanda alla landing page che raccoglie tutti i manuali, in modo da ridurre ulteriormente il consumo di carta.

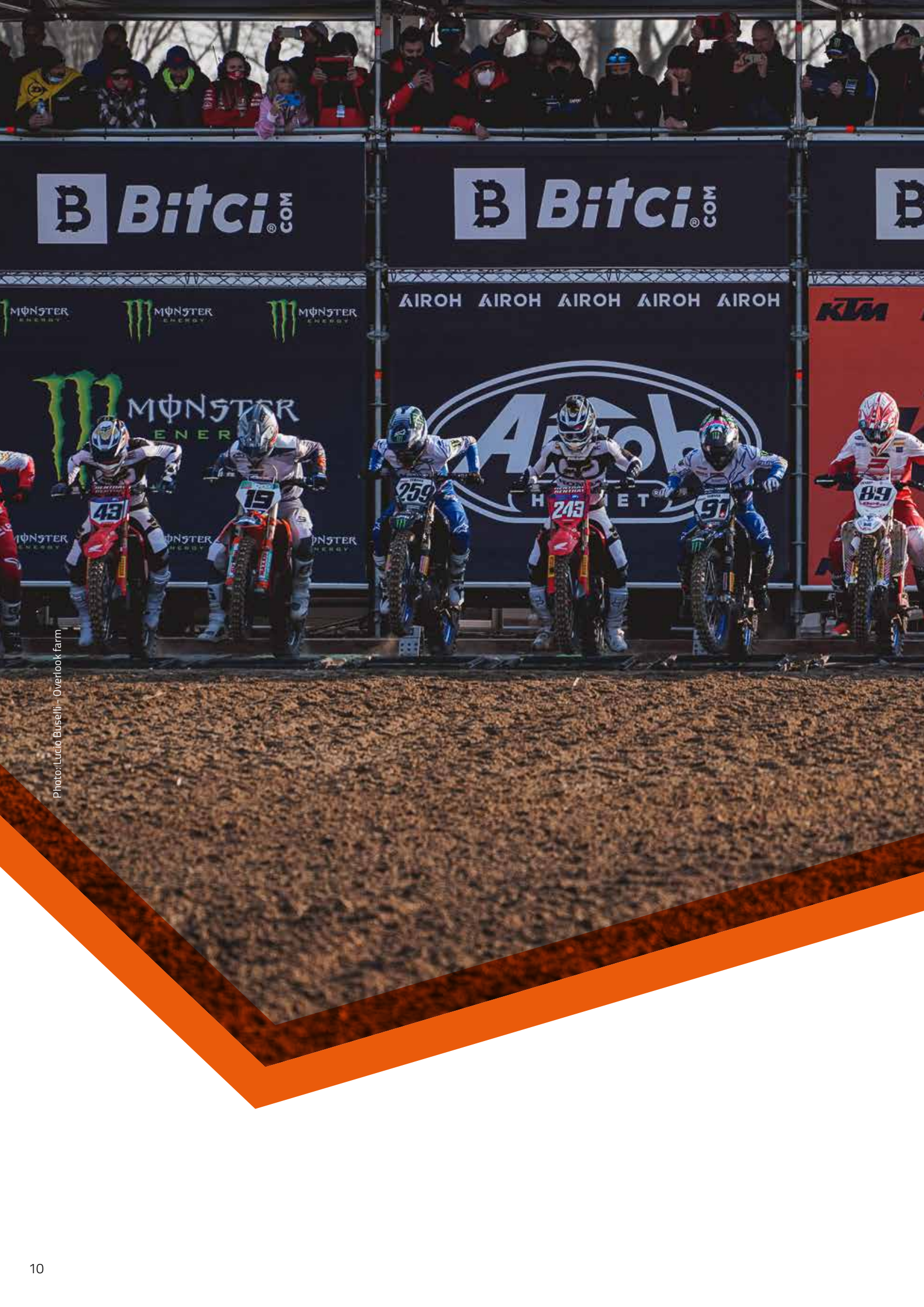

**Bitci.COM**

**Bitci.COM**

MONSTER ENERGY

AIROH AIROH AIROH AIROH AIROH

KTM

MONSTER ENERGY

AIROH

Photo: Lucio Buselli - Overlook farm



# OFFROAD ENGINE CONTROL

## MOTOCROSS

# WHAT GET OFFERS

COSA OFFRE GET

SMART SOS



GPA SWITCH



2<sup>ND</sup> INJECTOR KITS



LITHIUM BATTERIES AND BATTERY CHARGER



INJECTOR SUPPORT KIT



JUMPSTARTER MINI



ENGINE CONTROL UNITS

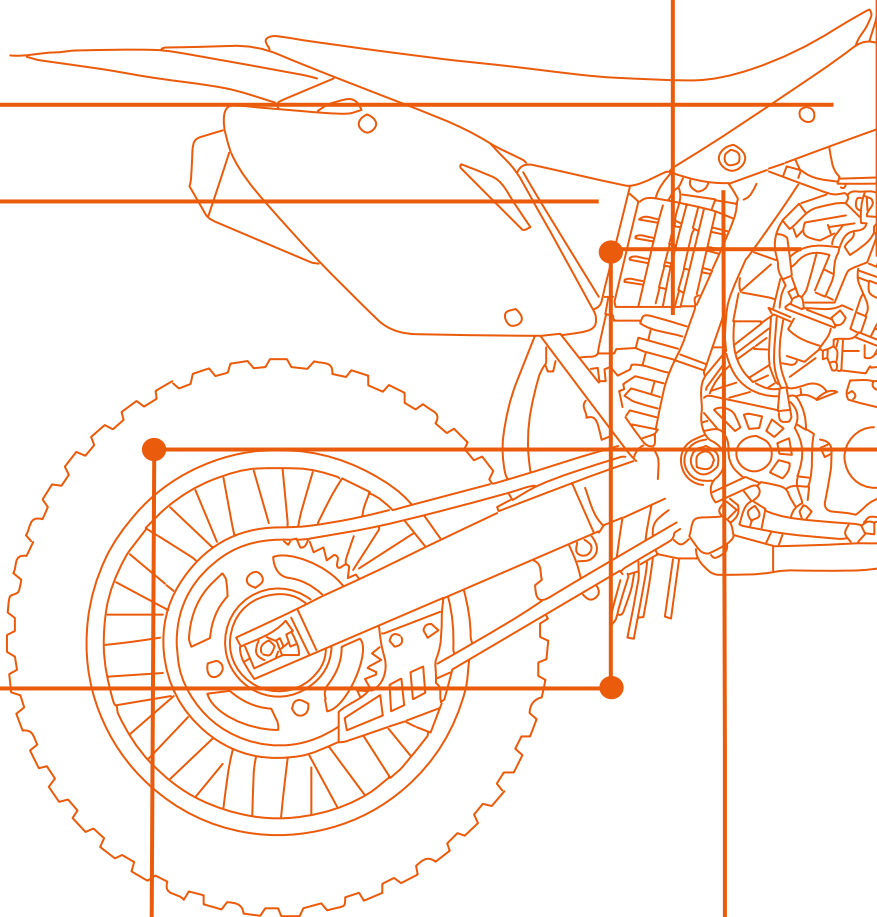

MAP SWITCH



HOUR METER



RPM DASH



LAUNCH AND TRACTION CONTROL SYSTEM



WIFI SETTING TOOL



DATA LOGGING DEVICES



SENSORS

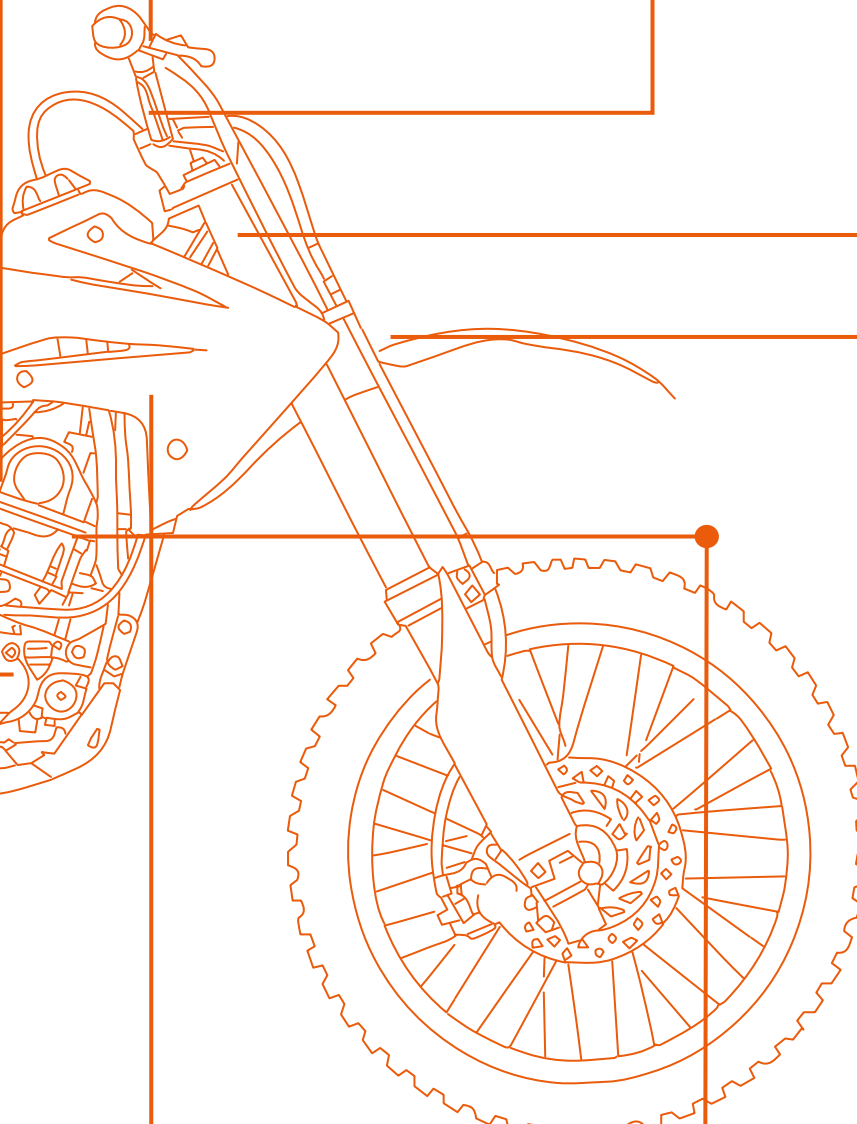

# CDI 2-STROKE

CDI UNITS FOR 2-STROKE MX ENGINES - CENTRALINE MOTORE 2T MX



DISCOVER MORE  
SCOPRI DI PIÙ



MAP1 MAP2

**INCLUDED IN THE KIT**  
INCLUSO NEL KIT



MAP SWITCH

CDI is the ECU for 2-stroke carburetor engines, it is the perfect device to optimize the management of the ignition curve and to maximize the engine performances. CDI is plug&play on standard engines and comes with 2 maps:

- Map 1: Racing
- Map 2: Wet

Via our MAYA software, sold separately, it will be possible to customize even further the ignition curve and adapt the maps according to your needs.

Thanks to the new updated firmware developed by GET R&D technicians, GET CDI now manages even better the performance even at high temperatures by adjusting the ignition curve after continuous and precise analysis of engine temperature.

CDI è la centralina per i modelli 2 tempi a carburatore in grado di gestire la curva di anticipo e di massimizzare le performance del motore. CDI è pronta all'uso su moto di serie con due mappe preinstallate:

- Mappa 1: Configurazione racing
- Mappa 2: Configurazione bagnato

Attraverso il software di programmazione MAYA, disponibile separatamente, è possibile modificare ulteriormente la curva d'anticipo per personalizzare la mappatura secondo le proprie necessità.

Grazie al nuovo aggiornamento del firmware sviluppato dai tecnici R&D GET, la centralina CDI ora gestisce ancora meglio le prestazioni anche ad alte temperature applicando un correttivo alla curva di anticipo dopo un'analisi continua e precisa della temperatura del motore.

## KEY BENEFITS

### PUNTI DI FORZA



2 PREINSTALLED  
RACING MAPS  
2 MAPPE RACING  
PREINSTALLATE



POWER  
MAXIMIZATION  
POTENZA E  
AFFIDABILITÀ







PLUG & PLAY  
INSTALLAZIONE  
IMMEDIATA



RIPROGRAMMABLE  
WITH MAYA SOFTWARE  
RIPROGRAMMABILE  
CON SOFTWARE MAYA

## APPLICATION LIST

### LISTA APPLICAZIONI

MODEL	APPLICATION	YEARS	P/N
	KTM SX 65	2018-2023	GK-CDI-0007
	KTM SX 85	2018-2023	GK-CDI-0003
	KTM SX 125	2019-2022	GK-CDI-0008
	KTM SX 250	2017-2022	GK-CDI-0004
	GASGAS MC 65	2021-2023	GK-CDI-0007
	GASGAS MC 85	2021-2023	GK-CDI-0003
	GASGAS MC 125	2021-2023	GK-CDI-0008
	Husqvarna TC 65	2018-2023	GK-CDI-0007
	Husqvarna TC 85	2018-2023	GK-CDI-0003
	Husqvarna TC 125	2019-2022	GK-CDI-0008
	Husqvarna TC 250	2017-2022	GK-CDI-0004
	Yamaha YZ 65	2018-2023	GK-CDI-0005
	Yamaha YZ 85	2019-2023	GK-CDI-0006
	Yamaha YZ 125	2022 - 2023	GK-CDI-0009
	Yamaha YZ 250	2006-2023	GK-CDI-0010

See hardware compatibility chapter at page 37  
Vedi il capitolo compatibilità hardware a pagina 37

## ADDITIONAL ACCESSORIES

### ACCESSORI AGGIUNTIVI



#### PA00040002

#### MAYA + CDI 2 Stroke Programming Cable

This programming pack includes the MAYA EVO licence software and the PC/CDI 2 stroke connection cable.

Questo pacchetto include il software di programmazione MAYA versione EVO e il cavo di comunicazione per le centraline CDI GET 2T



# RX1 PRO

ECUs FOR 4-STROKE MX ENGINES - CENTRALINE MOTORE 4T MX



COMMERCIAL  
VIDEO



DISCOVER MORE  
SCOPRI DI PIÙ



**INCLUDED IN THE KIT**  
**INCLUSO NEL KIT**



WiFi-COM



MAP SWITCH

RX1 PRO is the ECU for 4-stroke engines starting from 2018 onwards; a plug&play and fully programmable unit that makes this device the perfect mixture of technology and flexibility. RX1 PRO comes with 2 maps developed by GET R&D Department to maximize the performance of standard engine:

- Map1: Racing
- Map2: Racing + GPA "Traction Control" Level 5 to offer higher grip on difficult track conditions.

These maps are compatible with both standard and aftermarket exhausts systems. RX1 PRO is also the best solution in case of modified engines: it is possible to modify the calibration map through both WiGET App, by using the included WiFi-COM device, and/ or MAYA software (sold separately). Furthermore, RX1 PRO can be reconverted to other bike models (see Compatibility chart at page 37).

RX1 PRO è la centralina per motori 4 tempi ed è disponibile per i modelli a partire dal 2018 in avanti; un concentrato di tecnologia e flessibilità, perché pronta all'uso su motori di serie e totalmente personalizzabile nei parametri motore. RX1 PRO è dotata di due mappature motore, sviluppate dal reparto R&D GET:

- Mappa1: configurazione racing
- Mappa2: configurazione racing + "controllo di trazione" GPA impostato a livello 5, per un maggior controllo su terreni a scarsa aderenza

Queste mappature sono compatibili sia con impianti di scarico originali che aftermarket. RX1 PRO è la migliore soluzione anche per i motori preparati: in funzione della modifica meccanica, è infatti possibile effettuare una calibrazione ottimale sia tramite l'App WiGET, utilizzando il dispositivo WiFi-COM incluso nel kit, sia tramite il software professionale MAYA (fornito separatamente). RX1 PRO sarà sempre riconvertibile per altri modelli di moto (vedi Tabella di compatibilità a pag. 37).

## KEY BENEFITS

### PUNTI DI FORZA



2 PREINSTALLED  
RACING MAPS  
2 MAPPE RACING  
PREINSTALLATE



GPA TRACTION  
CONTROL  
CONTROLLO  
TRAZIONE GPA



ELECTRONIC LAUNCH  
CONTROL READY  
COMPATIBILE CON  
LAUNCH CONTROL  
ELETTRONICO



PLUG & PLAY  
INSTALLAZIONE  
IMMEDIATA









BAROMETRIC SENSOR  
SENSORE BAROMETRICO



PROGRAMMABLE  
THROUGH APP  
PERSONALIZZABILE  
TRAMITE APP

## APPLICATION LIST

## LISTA APPLICAZIONI

MODEL	APPLICATION	YEARS	P/N
	Honda 250 CRF R	2022 - 2023 2nd injector ready	GK-RX1PRO-0057
	Honda 450 CRF R	2023	GK-RX1PRO-0067
	Suzuki 250 RMZ	2019-2023	GK-RX1PRO-0034
	Suzuki 450 RMZ	2020-2023	GK-RX1PRO-0042
	Kawasaki 250 KX	2023	GK-RX1PRO-0062
	Kawasaki 450 KX	2022 - 2023	GK-RX1PRO-0058
	Yamaha 250 YZF	2021-2023 - 2nd injector ready	GK-RX1PRO-0053
	Yamaha 450 YZF	2023	GK-RX1PRO-0063
	KTM SXF 250	2023 - 2nd injector ready	GK-RX1PRO-0064
	KTM SXF 350	2023	GK-RX1PRO-0065
	KTM SXF 450	2023	GK-RX1PRO-0066
	GASGAS MC250F	2021-2023 - 2nd injector ready	GK-RX1PRO-0029
	GASGAS MC350F	2021-2023	GK-RX1PRO-0030
	GASGAS MC450F	2021-2023	GK-RX1PRO-0031
	Husqvarna FC 250	2023 - 2nd injector ready	GK-RX1PRO-0064
	Husqvarna FC 350	2023	GK-RX1PRO-0065
	Husqvarna FC 450	2023	GK-RX1PRO-0066

For all applications please visit our web site [athena.eu](http://athena.eu)  
Visita il sito [athena.eu](http://athena.eu) per la lista applicazioni completa

See hardware compatibility chapter at page 37  
Vedi il capitolo compatibilità hardware a pagina 37

## ADDITIONAL ACCESSORIES

## ACCESSORI AGGIUNTIVI

**LC-GPA**

Developed together with the top MXGP and US Teams worldwide, LC-GPA is the brand new device which combines the GPA Technology with an extremely efficient Launch Control System. (see page 32).

Progettato in collaborazione con i campioni mondiali di MX e SX, LC-GPA è il dispositivo che combina la tecnologia GPA di GET con un sistema Launch Control estremamente efficiente. (Vedi pagina 32).

**GK-CANSW-0001 - GPA SWITCH**

The GPA SWITCH is an handle to enable the GPA, the patented technology at the core of GET's success.

GPA SWITCH è una manopola che consente al pilota di modificare in tempo reale il livello di intervento del sistema GPA.

**2nd INJECTOR KIT - only for 250cc**

The 2nd INJECTOR KIT has been developed to increase the performance on 250cc MX engines and to support the stock injector maximizing the engine power and improving drivability.

Il Kit Secondo Iniettore è stato studiato per aumentare le prestazioni dei motori MX 250cc e supportare il lavoro dell'iniettore originale, massimizzando la potenza della moto migliorandone la guidabilità.

**GL-0084-AA****Connecting Cable for WiFi-COM and GPA device**

This split cable allows the simultaneous connection and installation on the bike of the WiFi-COM device and the LC-GPA/GPA SWITCH device.

Questo cavo sdoppiatore consente il collegamento e l'installazione simultanea sulla moto del dispositivo WiFi-COM e di LC-GPA o GPA SWITCH.

# RX1 PRO TUNER

ECUs FOR 4-STROKE MX ENGINES - CENTRALINE MOTORE 4T MX



**INCLUDED IN THE KIT**  
**INCLUSO NEL KIT**



MAP SWITCH

RX1 PRO TUNER is the perfect solution for professional tuners working with our MAYA software (sold separately). It is an empty ECU, totally customizable for 4-stroke engines starting from 2018 onwards. It comes with our map switch, 2nd injector cable and no other accessory to allow maximum flexibility and the best value for money. Depending on the bike model, it is possible to choose one of the three hardware configurations listed in the Compatibility chart at page 40. Maps are free to download from our website. RX1 PRO TUNER is also compatible with the WiGET App by using the WiFi-COM device (sold separately).

RX1 PRO TUNER è la soluzione perfetta per i preparatori che lavorano con il nostro software professionale MAYA (venduto separatamente). È una centralina vuota, completamente personalizzabile per motori 4 tempi a partire dai modelli 2018 in avanti. Viene fornita con il selettore di mappa, il cavo secondo iniettore e nessun altro accessorio per garantire massima flessibilità e un ottimo rapporto qualità/ prezzo. In base al modello di moto, si può scegliere fra le tre configurazioni hardware elencate nella Tabella di conversione a pag. 40. Le mappe sono liberamente scaricabili dal nostro sito. RX1 PRO TUNER è ugualmente compatibile anche con l'App WiGET grazie al modulo WiFi-COM (venduto separatamente).

## KEY BENEFITS

### PUNTI DI FORZA



**MAXIMUM FLEXIBILITY**  
 FLESSIBILITÀ  
 MASSIMA



**VALUE FOR MONEY**  
 PREZZO VANTAGGIOSO



**GPA TRACTION CONTROL**  
 CONTROLLO  
 TRAZIONE GPA



**ELECTRONIC LAUNCH CONTROL READY**  
 COMPATIBILE CON  
 LAUNCH CONTROL  
 ELETTRONICO



**TOTALLY CUSTOMIZABLE**  
 TOTALMENTE  
 PERSONALIZZABILE

## APPLICATION LIST

### LISTA APPLICAZIONI

APPLICATION	YEARS	P/N
HW 1 (YAM 250 2019-2023 / 450 2018-2022)		GK-RX1TNR-0001
HW 2 (SUZ 250 2018 / 450 2018-2019)		GK-RX1TNR-0002
HW 3 - all other ECUs*	2018 - 2023	GK-RX1TNR-0003

\*See hardware compatibility chapter at page 37

\*Vedi il capitolo compatibilità hardware a pagina 37

## ADDITIONAL ACCESSORIES

### ACCESSORI AGGIUNTIVI



#### LC-GPA

Developed together with the top MXGP and US Teams worldwide, LC-GPA is the brand new device which combines the GPA Technology with an extremely efficient Launch Control System. (see page 32).

Progettato in collaborazione con i campioni mondiali di MX e SX, LC-GPA è il dispositivo che combina la tecnologia GPA di GET con un sistema Launch Control estremamente efficiente. (Vedi pagina 32).



#### GK-CANSW-0001 - GPA SWITCH

The GPA SWITCH is an handle to enable the GPA, the patented technology at the core of GET's success.

GPA SWITCH è una manopola che consente al pilota di modificare in tempo reale il livello di intervento del sistema GPA.



#### 2nd INJECTOR KIT - only for 250cc

The 2nd INJECTOR KIT has been developed to increase the performance on 250cc MX engines and to support the stock injector maximizing the engine power and improving drivability.

Il Kit Secondo Iniettore è stato studiato per aumentare le prestazioni dei motori MX 250cc e supportare il lavoro dell'iniettore originale, massimizzando la potenza della moto migliorandone la guidabilità.



#### GL-0084-AA

##### Connecting Cable for WiFi-COM and GPA device

This split cable allows the simultaneous connection and installation on the bike of the WiFi-COM device and the LC-GPA/GPA SWITCH device.

Questo cavo sdoppiatore consente il collegamento e l'installazione simultanea sulla moto del dispositivo WiFi-COM e di LC-GPA o GPA SWITCH.



#### GK-WFCOM2-0001 - WiFi-COM

GET provides all riders with a smart device that allows the modification of the main engine parameters by simply using a smartphone or a tablet thanks to the WiGET app, available for iOS and Android systems.

GET fornisce a tutti i piloti un dispositivo che permette di modificare i principali parametri motore connettendo semplicemente il proprio Smartphone o Tablet al dispositivo WiFi-COM grazie all'app gratuita WiGET disponibile per sistemi iOS e Android.

# PRO FACTORY KIT

## RX1 PRO ECU + SECOND INJECTOR KIT

### CENTRALINA RX1 PRO + KIT SECONDO INIETTORE



**INCLUDED IN THE KIT**  
**INCLUSO NEL KIT**



WiFi-COM



MAP SWITCH

PRO FACTORY KIT is the racing kit composed by RX1 PRO ECU and 2nd injector, developed by GET R&D Department to optimize the flow of fuel at mid and top, guaranteeing better performance. The kit is designed for 250cc 4-stroke engines starting from 2018 onwards and takes the most out of the engine without compromising the reliability. RX1 PRO in the kit is ready with two maps:

- Map 1: for a standard engine with OEM single injector
- Map 2: for a standard engine with GET second injector.

These maps are totally reprogrammable through both WIGET App, by using the included WiFi-COM device, and/ or MAYA software (sold separately). The mounting instructions included in the kit allows a quick and intuitive installation, without any further engine modifications needed.

PRO FACTORY è il kit da competizione composto da centralina e secondo iniettore, messo a punto dal reparto R&D GET per ottimizzare il flusso di carburante ai medi e alti regimi, garantendo maggiori prestazioni e fluidità. Il kit è progettato per i motori 4 tempi 250cc a partire dal 2018 in avanti, e consente di sfruttare al massimo la potenza del motore senza comprometterne l'affidabilità.

La centralina RX1 PRO in dotazione offre due mappature:

- Mappa1: studiata per motore con iniettore originale
- Mappa 2: progettata per funzionare in abbinata al secondo iniettore GET.

Entrambe le mappature sono completamente riprogrammabili sia tramite l'App WIGET, utilizzando il dispositivo WiFi-COM incluso nel kit, sia tramite il software professionale MAYA (fornito separatamente). Le istruzioni di montaggio incluse nel kit rendono l'installazione del secondo iniettore estremamente intuitiva, non richiedendo ulteriori modifiche al motore.

## KEY BENEFITS

### PUNTI DI FORZA



**MORE OVERALL  
POWER AND MAXIMUM  
RELIABILITY**  
PIÙ POTENZA E  
MASSIMA AFFIDABILITÀ



**2 PREINSTALLED  
RACING MAPS**  
2 MAPPE RACING  
PREINSTALLATE



**PLUG & PLAY ON  
STANDARD ENGINE**  
PRONTO ALL'USO SU  
MOTO DI SERIE



**COMPLETE WITH  
INSTALLATION MANUAL**  
COMPLETO DI  
ISTRUZIONI MONTAGGIO  
DETTAGLIATE



**PROGRAMMABLE  
THROUGH APP**  
PERSONALIZZABILE  
TRAMITE APP







**GPA TRACTION  
CONTROL**  
CONTROLLO  
TRAZIONE GPA



**ELECTRONIC LAUNCH  
CONTROL READY**  
COMPATIBILE CON  
LAUNCH CONTROL  
ELETTRONICO

## APPLICATION LIST

## LISTA APPLICAZIONI

MODEL	APPLICATION	YEARS	P/N
	Honda 250 CRF R	2022 - 2023	GK-RX1PROFTY-0032
	Yamaha 250 YZF	2021-2023	GK-RX1PROFTY-0031
	KTM SXF 250	2023	GK-RX1PROFTY-0033
	GASGAS MC250F	2021-2023	GK-RX1PROFTY-0027
	Husqvarna FC 250	2023	GK-RX1PROFTY-0033

For all applications please visit our web site [athena.eu](http://athena.eu)  
 Visita il sito [athena.eu](http://athena.eu) per la lista applicazioni completa

## ADDITIONAL ACCESSORIES

## ACCESSORI AGGIUNTIVI

**LC-GPA**

Developed together with the top MXGP and US Teams worldwide, LC-GPA is the brand new device which combines the GPA Technology with an extremely efficient Launch Control System. (see page 32).

Progettato in collaborazione con i campioni mondiali di MX e SX, LC-GPA è il dispositivo che combina la tecnologia GPA di GET con un sistema Launch Control estremamente efficiente. (Vedi pagina 32).

**GK-CANSW-0001 - GPA SWITCH**

The GPA SWITCH is an handle to enable the GPA, the patented technology at the core of GET's success.

GPA SWITCH è una manopola che consente al pilota di modificare in tempo reale il livello di intervento del sistema GPA.

**GL-0084-AA****Connecting Cable for WiFi-COM and GPA device**

This split cable allows the simultaneous connection and installation on the bike of the WiFi-COM device and the LC-GPA/GPA SWITCH device.

Questo cavo sdoppiatore consente il collegamento e l'installazione simultanea sulla moto del dispositivo WiFi-COM e di LC-GPA o GPA SWITCH.



# OFFROAD ENGINE CONTROL

## ENDURO



# ECULMB 2 STROKE EFI RACE KIT

ECUs FOR 2-STROKE FUEL INJECTED ENGINES + INJECTORS SUPPORT KIT  
CENTRALINE MOTORI 2T AD INIEZIONE + KIT SUPPORTO INIETTORI



DISCOVER MORE  
SCOPRI DI PIÙ

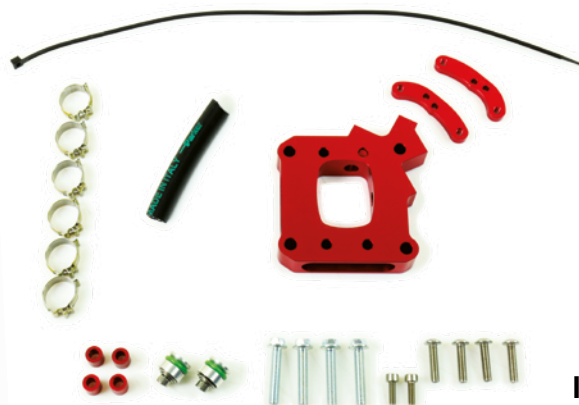

**INCLUDED IN THE KIT**  
**INCLUSO NEL KIT**



WiFi-COM



MAP SWITCH

RACE KIT allows an even more enjoyable riding experience and it is the best choice for racing. It includes the innovative ECULMB unit, developed for 2-stroke injection engines of the enduro models by KTM/ Husqvarna/ GASGAS, and an aluminium injectors support. With this kit, the injectors will be moved between cylinder and throttle body, allowing a totally smoother rideability and a huge power increase, especially at low/medium RPM. The ECU included in the RACE KIT comes with 2 different maps:

- Map1: Racing configuration for full power
- Map 2: Balanced configuration for a smooth power delivery

These maps are totally reprogrammable through both WiGET App, by using the included WiFi-COM device, and/ or MAYA software (sold separately).

Il RACE KIT offre un'esperienza di guida ancora più entusiasmante, ideale per il mondo delle competizioni. È composto dall'innovativa centralina ECULMB, sviluppata per i modelli enduro 2tempi ad iniezione di KTM/ Husqvarna/ GASGAS, e dal Kit per lo spostamento degli iniettori con staffa in alluminio. Il kit permette di riposizionare gli iniettori fra il cilindro ed il corpo farfallato: questa modifica rende la moto estremamente fluida da guidare e molto più potente, in particolare ai regimi medio/bassi. La centralina in dotazione offre due diverse mappature sviluppate appositamente per il RACE KIT:

- Mappa1: Configurazione Racing per la massima potenza for full power
- Mappa 2: Configurazione Soft per un'erogazione bilanciata della potenza

Entrambe le mappature sono completamente riprogrammabili sia tramite l'App WiGET, utilizzando il dispositivo WiFi-COM incluso nel kit, sia tramite il software professionale MAYA (fornito separatamente).

## KEY BENEFITS

### PUNTI DI FORZA



**MORE OVERALL  
POWER AND MAXIMUM  
RELIABILITY**  
PIÙ POTENZA E  
MASSIMA AFFIDABILITÀ



**OPTIMIZATION OF  
THE INJECTION**  
OTTIMIZZAZIONE  
DELL'INIEZIONE



**TRACTION  
CONTROL GPA**  
CONTROLLO  
TRAZIONE GPA



**PROGRAMMABLE  
THROUGH APP**  
PERSONALIZZABILE  
TRAMITE APP



**REPROGRAMMABLE  
WITH SOFTWARE MAYA**  
RIPROGRAMMABILE  
CON SOFTWARE MAYA





**COMPLETE WITH  
INSTALLATION MANUAL**  
COMPLETO DI  
ISTRUZIONI MONTAGGIO  
DETTAGLIATE



**2 PREINSTALLED  
RACING MAPS**  
2 MAPPE RACING  
PREINSTALLATE

## APPLICATION LIST

### LISTA APPLICAZIONI

MODEL	APPLICATION	YEARS	P/N
	KTM EXC 250	2020-2023	GK-KIT2TI-0004
	KTM EXC 300	2020-2023	GK-KIT2TI-0003
	GASGAS EC 250	2021-2023	GK-KIT2TI-0004
	GASGAS EC 300	2021-2023	GK-KIT2TI-0003
	Husqvarna TE 250i	2020-2023	GK-KIT2TI-0004
	Husqvarna TE 300i	2020-2023	GK-KIT2TI-0003

For all applications please visit our web site [athena.eu](http://athena.eu)  
 Visita il sito [athena.eu](http://athena.eu) per la lista applicazioni completa

See hardware compatibility chapter at page 37  
 Vedi il capitolo compatibilità hardware a pagina 37

## DYNO POWER GRAPH

### CURVA DI POTENZA AL BANCO PROVA

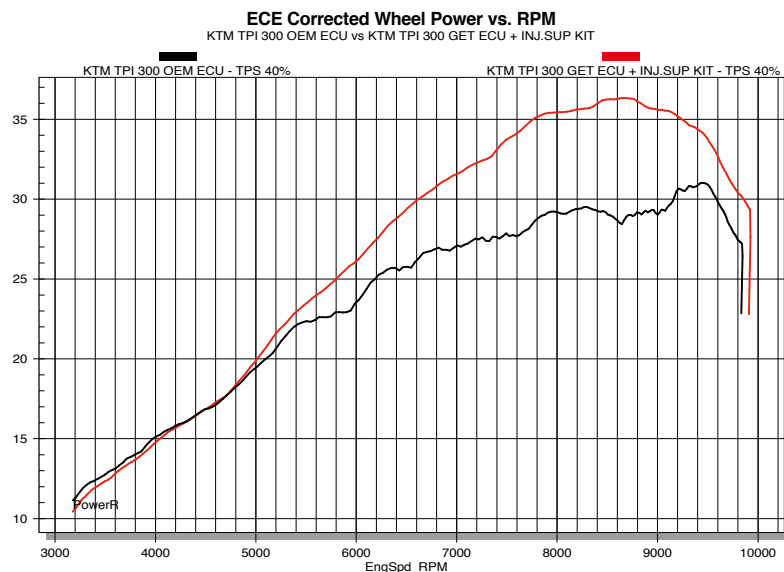

**40% THROTTLE POSITION**  
 HUGE POWER AND TORQUE  
 INCREMENT AS WELL AS BETTER  
 DRIVABILITY AND THROTTLE  
 RESPONSE

**40% APERTURA GAS**  
 MASSIVO AUMENTO DI POTENZA E  
 COPPIA, UNA MAGGIOR RISPOSTA  
 DEL GAS E GUIDABILITÀ MIGLIORE

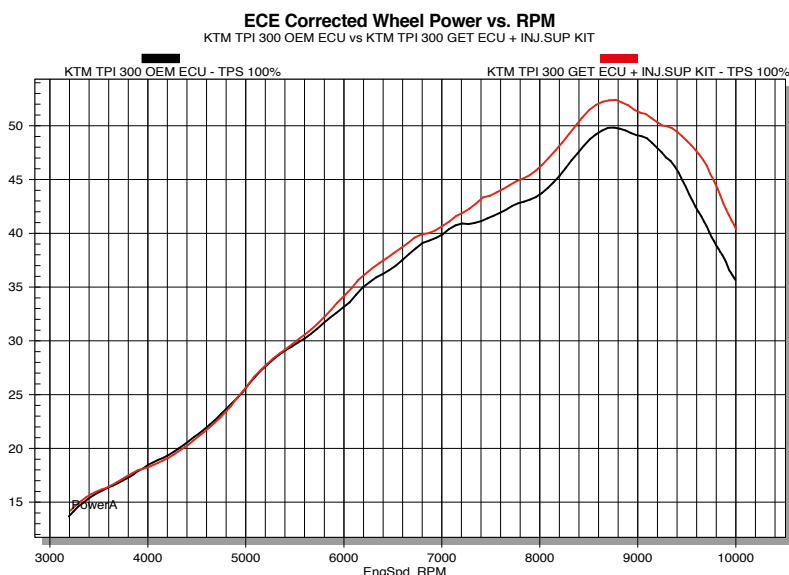

**100% THROTTLE POSITION**  
 MORE POWER OVERALL

**100% APERTURA GAS**  
 AUMENTO DI POTENZA SU TUTTO  
 L'ARCO DI UTILIZZO

## ADDITIONAL ACCESSORIES

### ACCESSORI AGGIUNTIVI



#### GK-CANSW-0001 - GPA SWITCH

The GPA SWITCH is an handle to enable the GPA, the patented technology at the core of GET's success.

GPA SWITCH è una manopola che consente al pilota di modificare in tempo reale il livello di intervento del sistema GPA.



#### GL-0084-AA

##### Connecting Cable for WiFi-COM and GPA device

This split cable allows the simultaneous connection and installation on the bike of the WiFi-COM device and the LC-GPA/GPA SWITCH device.

Questo cavo sdoppiatore consente il collegamento e l'installazione simultanea sulla moto del dispositivo WiFi-COM e di LC-GPA o GPA SWITCH.



#### LC-GPA

Developed together with the top MXGP and US Teams worldwide, LC-GPA is the brand new device which combines the GPA Technology with an extremely efficient Launch Control System. (see page 32).

Progettato in collaborazione con i campioni mondiali di MX e SX, LC-GPA è il dispositivo che combina la tecnologia GPA di GET con un sistema Launch Control estremamente efficiente. (Vedi pagina 32).



#### GL-0176-AA

##### ECULMB48M Counter connector

This connector allows to program the ECULMB easily from the desk together with a 12V battery like the RX1 ECUs. Unlike the RX1 ECUs, ECULMB can be programmed only when installed on the bike without this connector.

Questo connettore permette di programmare la centralina ECULMB comodamente dalla scrivania con ausilio di batteria 12V. A differenza delle RX1, senza questo accessorio la ECULMB può essere programmata solo se installata sulla moto.

## INJECTOR SUPPORT KIT FOR ECULMB 2 STROKE EFI

### INJECTORS SUPPORT KIT - KIT SUPPORTO INIETTORI

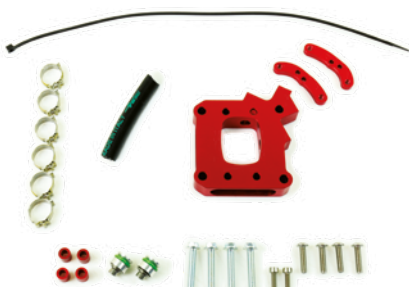

#### APPLICATION LIST

##### LISTA APPLICAZIONI

MODEL	APPLICATION	YEARS	P/N
	KTM EXC 300 TPI	2018 - 2023	GK-GMSUP-0008
	KTM EXC 250 TPI	2018 - 2023	GK-GMSUP-0008
	GASGAS EC 300	2021-2023	GK-GMSUP-0008
	GASGAS EC 250	2021-2023	GK-GMSUP-0008
	Husqvarna TE 300i	2018 - 2023	GK-GMSUP-0008
	Husqvarna TE 250i	2018 - 2023	GK-GMSUP-0008

This kit works only with GET ECUs. it doesn't work with stock/OEM ECUs  
Questo kit funziona solo con centraline GET. Non funziona con centraline originali



# ECULMB

ECUS FOR 2-STROKE FUEL INJECTED ENGINES  
CENTRALINE MOTORI 2T AD INIEZIONE



**INCLUDED IN THE KIT**  
**INCLUSO NEL KIT**



WiFi-COM

MAP SWITCH

GET presents a new range of control units for the electronic management of the innovative two-stroke Gas Gas, KTM and Husqvarna 250/300 TPI injection engines. This new high-performance ECU maximizes the results of the new engines of the motor manufacturers on all types of terrain, making the most of their power and optimizing the throttle response. In this way the riders will be able to set the maps and get a greater feeling when they are on the bike regardless of the type of terrain they face. The new control unit is easy to install thanks to the Plug&Play system and works with GET WiFi-COM (included in the kit), so that all riders can easily manage the engine parameters by simply configuring them through the free WiGET App.

The control unit offers two different maps:

- Map 1: Racing configuration for full power
- Map 2: Soft configuration for balanced power delivery

GET presenta una nuova gamma di centraline per la gestione elettronica degli innovativi motori due tempi a iniezione Gas Gas, KTM e Husqvarna 250/300 TPI. Questa nuova ECU altamente performante, massimizza i risultati dei nuovi motori delle case motoristiche su ogni tipo di terreno, sfruttando al meglio la loro potenza e ottimizzando la risposta del gas. In questo modo i piloti potranno impostare le mappe e ottenere un feeling maggiore quando sono in sella alla moto a prescindere dal tipo di terreno che affrontano. La nuova centralina è facile da installare grazie al sistema Plug & Play ed è abbinata al WiFi-COM (incluso nel kit), in modo che tutti i rider possano gestire facilmente i parametri del motore configurandoli semplicemente attraverso l'App gratuita WiGET.

La centralina offre due diverse mappature:

- Mappa 1: Configurazione Racing per la massima potenza
- Mappa 2: Configurazione Soft per un'erogazione bilanciata della potenza

## KEY BENEFITS

### PUNTI DI FORZA



**PLUG & PLAY**  
INSTALLAZIONE  
IMMEDIATA



**2 PREINSTALLED  
RACING MAPS**  
2 MAPPE RACING  
PREINSTALLATE



**POWER OPTIMIZATION  
AND RELIABILITY**  
OTTIMIZZAZIONE DELLA  
POTENZA E AFFIDABILITÀ



**GPA TRACTION  
CONTROL**  
CONTROLLO  
TRAZIONE GPA



**PROGRAMMABLE  
THROUGH APP**  
PERSONALIZZABILE  
TRAMITE APP





**RIPROGRAMMABLE  
WITH MAYA SOFTWARE**  
RIPROGRAMMABILE  
CON SOFTWARE MAYA



**COMPLETE WITH  
INSTALLATION MANUAL**  
COMPLETO DI  
ISTRUZIONI MONTAGGIO  
DETTAGLIATE

## APPLICATION LIST

### LISTA APPLICAZIONI

MODEL	APPLICATION	YEARS	P/N
	KTM EXC 250	2020-2023	GK-ECULMB48M-0019
	KTM EXC 300	2020-2023	GK-ECULMB48M-0018
	Husqvarna TE 250i	2020-2023	GK-ECULMB48M-0019
	Husqvarna TE 300i	2020-2023	GK-ECULMB48M-0018
	GAS GAS EC 250	2021-2023	GK-ECULMB48M-0019
	GASGAS EC 300	2021-2023	GK-ECULMB48M-0018

See hardware compatibility chapter at page 37  
Vedi il capitolo compatibilità hardware a pagina 37

## ADDITIONAL ACCESSORIES

### ACCESSORI AGGIUNTIVI



#### GK-CANSW-0001 - GPA SWITCH

The GPA SWITCH is an handle to enable the GPA, the patented technology at the core of GET's success.

GPA SWITCH è una manopola che consente al pilota di modificare in tempo reale il livello di intervento del sistema GPA.



#### GL-0084-AA

#### Connecting Cable for WiFi-COM and GPA device

This split cable allows the simultaneous connection and installation on the bike of the WiFi-COM device and the LC-GPA/GPA SWITCH device.

Questo cavo sdoppiatore consente il collegamento e l'installazione simultanea sulla moto del dispositivo WiFi-COM e di LC-GPA o GPA SWITCH.



#### LC-GPA

Developed together with the top MXGP and US Teams worldwide, LC-GPA is the brand new device which combines the GPA Technology with an extremely efficient Launch Control System. (see page 32).

Progettato in collaborazione con i campioni mondiali di MX e SX, LC-GPA è il dispositivo che combina la tecnologia GPA di GET con un sistema Launch Control estremamente efficiente. (Vedi pagina 32).



#### GL-0176-AA

#### ECULMB48M Counter connector

This connector allows to program the ECULMB easily from the desk together with a 12V battery like the RX1 ECUs. Unlike the RX1 ECUs, ECULMB can be programmed only when installed on the bike without this connector.

Questo connettore permette di programmare la centralina ECULMB comodamente dalla scrivania con ausilio di batteria 12V. A differenza delle RX1, senza questo accessorio la ECULMB può essere programmata solo se installata sulla moto.

# RX1 PRO

ECUs FOR 4-STROKE ENDURO ENGINES - CENTRALINE MOTORI ENDURO 4 TEMPI



COMMERCIAL VIDEO



DISCOVER MORE SCOPRI DI PIÙ



**INCLUDED IN THE KIT**  
**INCLUSO NEL KIT**



WiFi-COM

MAP SWITCH

RX1 PRO is the ECU for 4-stroke engines starting from 2018 onwards; a plug&play and fully programmable unit that makes this device the perfect mixture of technology and flexibility. RX1 PRO comes with 2 maps developed by GET R&D Department to maximize the performance of standard engine:

- Map1: Racing
- Map2: Racing + GPA "Traction Control" Level 5 to offer higher grip on difficult track conditions.

These maps are compatible with both standard and aftermarket exhausts systems. RX1 PRO is also the best solution in case of modified engines: it is possible to modify the calibration map through both WiGET App, by using the included WiFi-COM device, and/ or MAYA software (sold separately). Furthermore, RX1 PRO can be reconverted to other bike models (see Compatibility chart at page 40).

RX1 PRO è la centralina per motori 4 tempi ed è disponibile per i modelli a partire dal 2018 in avanti; un concentrato di tecnologia e flessibilità, perché pronta all'uso su motori di serie e totalmente personalizzabile nei parametri motore. RX1 PRO è dotata di due mappature motore, sviluppate dal reparto R&D GET:

- Mappa1: configurazione racing
- Mappa2: configurazione racing + "controllo di trazione" GPA impostato a livello 5, per un maggior controllo su terreni a scarsa aderenza

Queste mappature sono compatibili sia con impianti di scarico originali che aftermarket. RX1 PRO è la migliore soluzione anche per i motori preparati: in funzione della modifica meccanica, è infatti possibile effettuare una calibrazione ottimale sia tramite l'App WiGET, utilizzando il dispositivo WiFi-COM incluso nel kit, sia tramite il software professionale MAYA (fornito separatamente). RX1 PRO sarà sempre riconvertibile per altri modelli di moto (vedi Tabella di compatibilità a pag. 40).

## KEY BENEFITS

### PUNTI DI FORZA



2 PREINSTALLED RACING MAPS  
2 MAPPE RACING PREINSTALLATE



GPA TRACTION CONTROL  
CONTROLLO TRAZIONE GPA



PLUG & PLAY  
INSTALLAZIONE IMMEDIATA



BAROMETRIC SENSOR  
SENSORE BAROMETRICO







PROGRAMMABLE THROUGH APP  
PERSONALIZZABILE TRAMITE APP



RIPROGRAMMABLE WITH MAYA SOFTWARE  
RIPROGRAMMABILE CON SOFTWARE MAYA

## APPLICATION LIST LISTA APPLICAZIONI

MODEL	APPLICATION	YEARS	P/N
	HONDA CRF-L 450	2019-2020	GK-RX1PRO-0056
	HONDA CRF-RL 450	2021-2023	GK-RX1PRO-0056
	YAMAHA WR 250 F	2022 - 2023	GK-RX1PRO-0060
	YAMAHA WR 450 F	2022 - 2023	GK-RX1PRO-0059
	KTM EXC-F 500	2020-2023	GK-RX1PRO-0049
	KTM EXC-F 450	2020-2023	GK-RX1PRO-0048
	KTM EXC-F 350	2020-2023	GK-RX1PRO-0047
	KTM EXC-F 250	2020-2023	GK-RX1PRO-0046
	GASGAS EC 250F	2021 - 2023	GK-RX1PRO-0046
	GASGAS EC 350F	2021 - 2023	GK-RX1PRO-0047
	Husqvarna FE 501	2020-2023	GK-RX1PRO-0049
	Husqvarna FE 450	2020-2023	GK-RX1PRO-0048
	Husqvarna FE 350	2020-2023	GK-RX1PRO-0047
	Husqvarna FE 250	2020-2023	GK-RX1PRO-0046

See hardware compatibility chapter at page 37  
Vedi il capitolo compatibilità hardware a pagina 37

## ADDITIONAL ACCESSORIES ACCESSORI AGGIUNTIVI



### GK-CANSW-0001 - GPA SWITCH

The GPA SWITCH is an handle to enable the GPA, the patented technology at the core of GET's success.

GPA SWITCH è una manopola che consente al pilota di modificare in tempo reale il livello di intervento del sistema GPA.



### GL-0084-AA

#### Connecting Cable for WiFi-COM and GPA device

This split cable allows the simultaneous connection and installation on the bike of the WiFi-COM device and the LC-GPA/GPA SWITCH device.

Questo cavo sdoppiatore consente il collegamento e l'installazione simultanea sulla moto del dispositivo WiFi-COM e di LC-GPA o GPA SWITCH.



### LC-GPA

Developed together with the top MXGP and US Teams worldwide, LC-GPA is the brand new device which combines the GPA Technology with an extremely efficient Launch Control System. (see page 32).

Progettato in collaborazione con i campioni mondiali di MX e SX, LC-GPA è il dispositivo che combina la tecnologia GPA di GET con un sistema Launch Control estremamente efficiente. (Vedi pagina 32).







# OFFROAD ENGINE CONTROL

## ATV

# ECULMB 4-STROKE

ECUs FOR YAMAHA 450 ATV ENGINES - CENTRALINE MOTORI ATV YAMAHA 450



**INCLUDED IN THE KIT**  
INCLUSO NEL KIT



WiFi-COM



MAP SWITCH

ECULMB for YFZ 450 R Yamaha ATVs is a highly versatile and professional product allowing the maximum personalization on settings and adjustments. With the Map Switch included to swap between two different map configurations in real time, this ECU can also be connected to the WiFi-COM device. Maps provided with this ECU are ready to use on a standard engine configuration and can be further modified to suit any requirements using WiFi-COM and/or MAYA Software.

La centralina ECULMB per Yamaha YFZ 450 R è un prodotto incredibilmente versatile, professionale e riesce a garantire elevata personalizzazione dei settaggi e parametri. Questa è senza dubbio la migliore soluzione per tutti i piloti che cercano una ECU estremamente tecnologica. Inoltre, grazie al Map Switch incluso, si può scegliere fra due diverse mappature in tempo reale. Le mappe previste in questa ECU sono pronte per essere utilizzate su motori con configurazione standard e possono essere ulteriormente modificate per soddisfare qualsiasi esigenza utilizzando WiFi-COM e/o MAYA Software.

## KEY BENEFITS

### PUNTI DI FORZA



**2 PREINSTALLED RACING MAPS**  
2 MAPPE RACING PREINSTALLATE



**GPA TRACTION CONTROL**  
CONTROLLO TRAZIONE GPA



**PLUG & PLAY**  
INSTALLAZIONE IMMEDIATA



**BAROMETRIC SENSOR**  
SENSORE BAROMETRICO





**PROGRAMMABLE THROUGH APP**  
PERSONALIZZABILE TRAMITE APP



**RIPROGRAMMABLE WITH MAYA SOFTWARE**  
RIPROGRAMMABILE CON SOFTWARE MAYA

## APPLICATION LIST

### LISTA APPLICAZIONI

MODEL	APPLICATION	YEARS	P/N
	YAMAHA YFZ 450 R	2014-2023	GK-ECULMB48M-0017
	YAMAHA YFM 700 R	2015 - 2022	UPCOMING

See hardware compatibility chapter at page 37  
Vedi il capitolo compatibilità hardware a pagina 37

## ADDITIONAL ACCESSORIES

### ACCESSORI AGGIUNTIVI



#### GK-CANSW-0001 - GPA SWITCH

The GPA SWITCH is an handle to enable the GPA, the patented technology at the core of GET's success.

GPA SWITCH è una manopola che consente al pilota di modificare in tempo reale il livello di intervento del sistema GPA.



#### GL-0084-AA

##### Connecting Cable for WiFi-COM and GPA device

This split cable allows the simultaneous connection and installation on the bike of the WiFi-COM device and the LC-GPA/GPA SWITCH device.

Questo cavo sdoppiatore consente il collegamento e l'installazione simultanea sulla moto del dispositivo WiFi-COM e di LC-GPA o GPA SWITCH.



#### LC-GPA

Developed together with the top MXGP and US Teams worldwide, LC-GPA is the brand new device which combines the GPA Technology with an extremely efficient Launch Control System. (see page 32).

Progettato in collaborazione con i campioni mondiali di MX e SX, LC-GPA è il dispositivo che combina la tecnologia GPA di GET con un sistema Launch Control estremamente efficiente. (Vedi pagina 32).





Photo: Lucio Buselli - Overlook farm



# OFFROAD ECUs & CDIs CONVERSION CHARTS



# RX1 PRO COMPATIBILITY - CONVERSION CHART

## COMPATIBILITÀ RX1 PRO - TABELLA DI CONVERSIONE

	<b>BIKE MODEL</b> MODELLO MOTO	<b>COMPATIBILITY</b> COMPATIBILITÀ
<b>HW PLATFORM 1</b> PIATTAFORMA HW 1	<b>Yamaha</b> YZ-F 250 2019 - 2023 YZ-F 450 2018 - 2022 WR-F 250 2022 - 2023 WR-F 450 2022 - 2023	Convertible with one another Convertibili l'una con l'altra
<b>HW PLATFORM 2</b> PIATTAFORMA HW 2	<b>Suzuki</b> RM-Z 250 2018 RM-Z 450 2018-2019	Convertible with one another Convertibili l'una con l'altra
<b>HW PLATFORM 3</b> PIATTAFORMA HW 3	<b>GASGAS</b> MC-F 250-450 2021-2023 EC-F 250-350 2021-2023  <b>KTM</b> SX-F 250-350-450 2018-2023 EXC-F 250-350-450-500 2020-2023  <b>Husqvarna</b> FC 250-350-450 2018-2023 FE 250-350-450-501 2020-2023  <b>Kawasaki</b> KX-F 250-450 2018-2023  <b>Honda</b> CRF 250-450 R/RX 2018-2023 CRF 450 L/RL 2019-2023* (Starting from M135RE)* (A partire da M135RE)*  <b>Suzuki</b> RM-Z 250 2019-2023 RM-Z 450 2020-2023	Convertible with one another Convertibili l'una con l'altra
<b>HW PLATFORM 4</b> PIATTAFORMA HW 4	<b>Yamaha</b> YZ-F 450 2023	Non-convertible Non convertibili

\*Check the label on the top of the control unit

\*Controlla l'etichetta sulla parte superiore della centralina



## CDI 2-STROKE COMPATIBILITY - CONVERSION CHART

### COMPATIBILITÀ CDI 2-STROKE - TABELLA DI CONVERSIONE

	BIKE MODEL MODELLO MOTO	COMPATIBILITY COMPATIBILITÀ
<b>HW PLATFORM 1</b> PIATTAFORMA HW 1	<b>GASGAS</b> MC 85 2021-2023 MC 125 2021-2023  <b>KTM</b> SX 85 2018-2023 SX 125 2016-2022 SX 250 2017-2022  <b>Husqvarna</b> TC 85 2018-2023 TC 125 2016-2022 TC 250 2017-2022	Convertible with one another Convertibili l'una con l'altra
<b>HW PLATFORM 2</b> PIATTAFORMA HW 2	<b>Yamaha</b> YZ 125 2005-2021	Non-convertible Non convertibili
<b>HW PLATFORM 3</b> PIATTAFORMA HW 3	<b>Yamaha</b> YZ 65 2018-2023 YZ 85 2019-2023	Convertible with one another Convertibili l'una con l'altra
<b>HW PLATFORM 4</b> PIATTAFORMA HW 4	<b>GASGAS</b> MC 65 2021-2023  <b>KTM</b> SX 65 2018-2023  <b>Husqvarna</b> TC 65 2018-2023	Non-convertible Non convertibili
<b>HW PLATFORM 5</b> PIATTAFORMA HW 5	<b>Yamaha</b> YZ 125 2022-2023 YZ 250 2006-2023	Convertible with one another Convertibili l'una con l'altra



## ECULMB COMPATIBILITY - CONVERSION CHART

### COMPATIBILITÀ ECU MB - TABELLA DI CONVERSIONE

	BIKE MODEL MODELLO MOTO	COMPATIBILITY COMPATIBILITÀ
<b>HW PLATFORM 1</b> PIATTAFORMA HW 1  (Up to MB20H)* (Fino a MB20H)*	<b>KTM</b> EXC 300 TPI 2018-2019 EXC 250 TPI 2018-2019  <b>Husqvarna</b> TE 300i 2018-2019 TE 250i 2018-2019	Convertible with one another Convertibili l'una con l'altra
<b>HW PLATFORM 2</b> PIATTAFORMA HW 2  (Starting from MB21H)* (A partire da MB21H)*	<b>GASGAS</b> EC 300 2021-2023 EC 250 2021-2023  <b>KTM</b> EXC 300 TPI 2018-2023 KTM EXC 250 TPI 2018-2023  <b>Husqvarna</b> TE 300i 2018-2023 TE 250i 2018-2023	Convertible with one another Convertibili l'una con l'altra
<b>HW PLATFORM 3</b> PIATTAFORMA HW 3	<b>Yamaha</b> YFZ 450R ATV 2014-2023	Non-convertible Non convertibili

\*Check the label on the top of the control unit  
\*Controlla l'etichetta sulla parte superiore della centralina

For more information please visit our web site [athena.eu](http://athena.eu)  
Visita il sito [athena.eu](http://athena.eu) per maggiori informazioni





Photo: Lucio Buselli - Overlook farm



# OFFROAD ECU ACCESSORIES

# LOOK BEYOND THE CORNER!



**GPA WILL TAKE YOU OUT!**

GPA (Get Power Assistance) Patented Technology: GET has developed and patented a unique power control system which works as a sort of traction control without any additional sensors. GPA manages and delivers the right power required in that specific condition in order to guarantee a safer ride whilst maintaining maximum performance.

GET ha sviluppato e brevettato un esclusivo sistema di controllo di potenza per il mondo off-road che lavora come una sorta di Traction Control ma senza utilizzare sensori esterni. GPA è in grado di gestire il corretto flusso di potenza richiesto, al fine di garantire condizioni di guida sicure, mantenendo, allo stesso tempo, massime prestazioni.



Photo: Lucio Buselli - Overlook farm

The chart shows data of a OEM ECU (black) and a GET ECU (red) in the same track, same corner and same motorcycle/rider. Il grafico mostra l'acquisizione dati di una centralina originale (nero) e una centralina GET (rosso) nella stessa pista e curva, con la stessa moto e pilota.

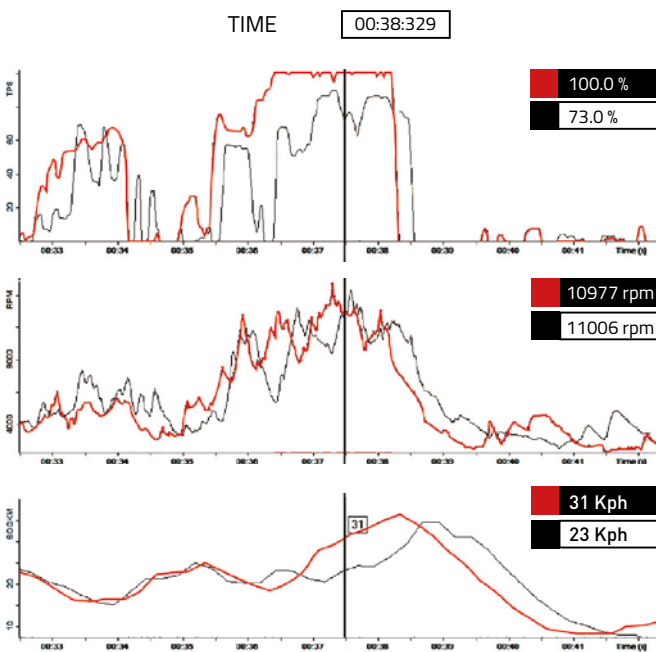

## THROTTLE

GPA allows the rider to go hard on the throttle and to focus only on the ride without worrying about losing control of the bike

## ACCELERATORE

Il GPA consente al pilota di spalancare il gas e concentrarsi solo sulla gara, senza il pensiero di perdere il controllo della moto.

## RPM

GPA reduces automatically RPMs recognizing when the rear wheel is about to spin excessively

## RPM

Il GPA riduce automaticamente i giri motore, individuando quando la ruota posteriore sta per slittare eccessivamente

## SPEED

GPA allows faster corners with less mental and physical efforts

## VELOCITÀ

Il GPA permette di avere velocità molto più elevate ad ogni curva e miglior tempo sul giro, preservando le energie del pilota



# LC-GPA

PERFECT FOR MOTOCROSS  
PERFETTO PER MOTOCROSS

## LAUNCH & "TRACTION CONTROL" SYSTEM SISTEMA LAUNCH & "TRACTION CONTROL"



DISCOVER MORE  
SCOPRI DI PIÙ



### INCLUDED IN THE KIT INCLUSO NEL KIT



BRACKET

LC-GPA is an essential device for motocross riders and it was born from our deep experience in racing competitions, where everybody agrees that good starts are crucial. The device combines the GPA patented technology ("traction control") with an extremely efficient Launch Control electronic strategy.

Thanks to the twelve LEDs, the riders will always be able to understand the right RPM range to get out of the starting gate. For every specific bike, GET engineers have developed the best starting strategy in terms of ideal power delivery necessary until the very first corner. This tool also allows modulating in real-time up to 10 levels of our sophisticated GPA (GET Power Assistance) technology. LC-GPA is available for all GET RX1 ECUs from 2016 onwards. Furthermore, the LEDs offer other valuable functions such as shift-light and overheat alarm. These functions can be easily activated via WiGET App.

LC-GPA è il dispositivo imprescindibile per ogni pilota e nasce dall'esperienza maturata nelle competizioni motocross, dove tutti concordano sul fatto che una buona partenza sia cruciale. Il dispositivo combina la tecnologia brevettata GPA ("controllo di trazione") con un sistema elettronico di Launch Control.

Attraverso i dodici LED presenti sul dispositivo, i piloti sapranno riconoscere il corretto regime di giri a cui portare la propria moto per uscire dal cancelletto. Gli ingegneri GET hanno sviluppato per ogni specifica moto la miglior strategia di partenza in termini di erogazione della potenza ideale necessaria per affrontare il rettilineo fino alla prima curva. Questo strumento permette inoltre di modulare in tempo reale fino a 10 livelli della nostra sofisticata tecnologia GPA ("Get Power Assistance"). LC-GPA è compatibile con tutte le centraline GET RX1 dal 2016 in poi e, attraverso la app WiGET, può essere utilizzato anche come indicatore di cambiata o come spia della temperatura motore.

### KEY BENEFITS

#### PUNTI DI FORZA



10 LEVELS OF  
TRACTION CONTROL  
10 LIVELLI DI CONTROLLO  
DI TRAZIONE



COMPATIBLE WITH  
RX1 AND ECU LMB ECUS  
COMPATIBILE CON  
CENTRALINE RX1 E  
ECU LMB



LAUNCH CONTROL USED BY  
THE BEST MX TEAMS  
LAUNCH CONTROL  
UTILIZZATO DAI MIGLIORI  
TEAM MX



GEAR SHIFT  
INDICATOR  
INDICATORE DI  
CAMBIATA









PROGRAMMABLE  
THROUGH APP  
PERSONALIZZABILE  
TRAMITE APP



WATER, MUD AND  
STONE PROOF  
RESISTENTE AD ACQUA  
FANGO E SASSI

## APPLICATION LIST

## LISTA APPLICAZIONI

MODEL	APPLICATION	YEARS	P/N
	Honda 250 CRF R	2016 - 2023	GK-LCGPA-0003
	Honda 450 CRF R	2016 - 2023	GK-LCGPA-0003
	Suzuki 250 RMZ	2016 - 2023	GK-LCGPA-0003
	Suzuki 450 RMZ	2018 - 2023	GK-LCGPA-0003
	Kawasaki 250 KX	2016 - 2023	GK-LCGPA-0001
	Kawasaki 450 KX	2016 - 2023	GK-LCGPA-0001
	Yamaha 250 YZF	2016 - 2023	GK-LCGPA-0002
	Yamaha 450 YZF	2016 - 2022	GK-LCGPA-0003
	KTM SXF 250	2016 - 2023	GK-LCGPA-0002
	KTM SXF 350	2016 - 2023	GK-LCGPA-0002
	KTM SXF 450	2016 - 2023	GK-LCGPA-0002
	GASGAS MC 250F	2021-2023	GK-LCGPA-0002
	GASGAS MC 450F	2021-2023	GK-LCGPA-0002
	Husqvarna FC 250	2016 - 2023	GK-LCGPA-0002
	Husqvarna FC 350	2016 - 2023	GK-LCGPA-0002
	Husqvarna FC 450	2016 - 2023	GK-LCGPA-0002

LCGPA works only with GET ECUs. it doesn't work with stock/OEM ECUs  
LCGPA funziona solo con centraline GET. Non funziona con centraline originali

For all applications please visit our web site [athena.eu](http://athena.eu)  
Visita il sito [athena.eu](http://athena.eu) per la lista applicazioni completa

## ADDITIONAL ACCESSORIES

## ACCESSORI AGGIUNTIVI

**GL-0084-AA****Connecting Cable for WiFi-COM and GPA device**

This split cable allows the simultaneous connection and installation on the bike of the WiFi-COM device and the LC-GPA/GPA SWITCH device.

Questo cavo sdoppiatore consente il collegamento e l'installazione simultanea sulla moto del dispositivo WiFi-COM e di LC-GPA o GPA SWITCH.

MODE BUTTON: included for applications without OEM button.

MODE BUTTON: Incluso per le applicazioni che non hanno il bottone di serie.



# GPA SWITCH

PERFECT FOR ENDURO  
PERFETTO PER ENDURO

"TRACTION CONTROL" DEVICE

SISTEMA DI "CONTROLLO TRAZIONE"



The GPA SWITCH is the best ally for Enduro riders. Uncomplicated, straightforward, indestructible, it allows modulating in real-time up to 10 levels of our sophisticated and patented "GPA power assistance" technology and guarantees the best traction for any surface. The device can be installed directly on the handlebar and it has been conceived to be water, mud and stone-proof.

Il GPA SWITCH è il migliore alleato dei piloti Enduro. Semplice, immediato, indistruttibile, permette di modulare in tempo reale fino a 10 livelli della nostra sofisticata e brevettata tecnologia GPA (Get Power Assistance) e assicura la miglior trazione su ogni superficie. Il dispositivo può essere installato direttamente sul manubrio ed è stato concepito per resistere ad acqua, fango e pietre.



## KEY BENEFITS

### PUNTI DI FORZA



10 LEVELS OF  
TRACTION CONTROL  
10 LIVELLI DI CONTROLLO  
DI TRAZIONE



COMPATIBLE WITH  
RX1 PRO AND ECULMB  
COMPATIBILE CON  
CENTRALINE RX1 PRO E  
ECULMB



PLUG & PLAY  
INSTALLAZIONE  
IMMEDIATA



WATER, MUD AND  
STONE PROOF  
RESISTENTE AD ACQUA  
FANGO E SASSI

## APPLICATION LIST

### LISTA APPLICAZIONI

APPLICATION	P/N
ALL OFFROAD GET ECUS	GK-CANSW-0001

For all applications please visit our web site [athena.eu](http://athena.eu)  
Visita il sito [athena.eu](http://athena.eu) per la lista applicazioni completa





# WiFi-COM

WIRELESS ECU CALIBRATION DEVICE

STRUMENTO WIRELESS DI SETTAGGIO CENTRALINA



WiGET APP



"GET SMART SOS" APP FEATURES  
FUNZIONALITÀ DELL'APP "GET SMART SOS"



WiFi-COM is a smart device that allows the modification of the main engine parameters by simply using a smartphone or a tablet thanks to the WiGET app, available for iOS and Android systems.

New customization possibilities are offered for the RX1 PRO ECUs from 2018 up such as additional map profiles, pre-installed by the GET engineers, for different track conditions or riding styles and mapping on specific brake-points

WiFi-COM è un dispositivo che permette di collegare semplicemente il proprio Smartphone o Tablet alla centralina GET grazie all'app gratuita WiGET disponibile per sistemi iOS e Android.

GET offre possibilità ancora maggiori di personalizzazione per i modelli RX1 PRO dal 2018 ad oggi, consentendo di intervenire su specifici punti della mappa per applicare correzioni in tempo reale e selezionare dei profili preinstallati per provare immediatamente differenti settaggi di mappa.

## KEY BENEFITS

### PUNTI DI FORZA



**PLUG & PLAY**  
INSTALLAZIONE  
IMMEDIATA



**COMPATIBLE WITH  
ALL GET ECUS**  
COMPATIBILE CON  
TUTTE LE CENTRALINE GET



**REAL TIME DIAGNOSTIC  
AND ENGINE MANAGEMENT  
AVAILABLE**  
DIAGNOSTICA E MODIFICA  
I PARAMETRI MOTORE  
REAL TIME



**PROGRAMMABLE  
THROUGH APP**  
PERSONALIZZABILE  
TRAMITE APP

## APPLICATION LIST

### LISTA APPLICAZIONI

APPLICATION	P/N
ALL GET RX1 AND ECU LMB ECUS	GK-WFCOM2-0001

For all applications please visit our web site [athena.eu](http://athena.eu)  
Visita il sito [athena.eu](http://athena.eu) per la lista applicazioni completa

## ADDITIONAL ACCESSORIES

### ACCESSORI AGGIUNTIVI



#### GL-0084-AA Connecting Cable for WiFi-COM and GPA device

This split cable allows the simultaneous connection and installation on the bike of the WiFi-COM device and the LC-GPA/GPA SWITCH device.

Questo cavo sdoppiatore consente il collegamento e l'installazione simultanea sulla moto del dispositivo WiFi-COM e di LC-GPA o GPA SWITCH.

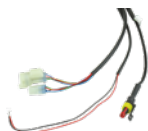

#### GL-0170-AA Power Supply Cable for GET WiFi-COM

This cable allows to connect WiFi-COM to a fully charged 12V battery and power it up to map while the engine is off. This needs to avoid engine overheating while mapping.

Il cavo consente di alimentare il WiFi-COM tramite una batteria a 12 V e mappare mentre il motore è spento. Questo serve ad evitare un surriscaldamento del motore mentre si programma.



**WIDGET Free App** Available for iOS and Android (see page 66)  
**WIDGET Applicazione gratuita** Disponibile per iOS ed Android (vedi pagina 66)



Modify ignition timing and injection. Increase the limiter up to 500 RPM more than OEM. Gear-cut function for GET quick-shifter-equipped bikes.

Modifica anticipo e iniezione. Aumenta il limitatore fino a 500 giri in più dell'originale. Gestione tempi di cambiata per moto che montano il quick-shifter GET

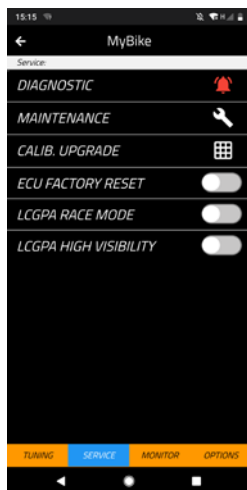

Check the diagnostics in real time to verify the status of your bike. Check the working hours of your ECU. Perform the O-TPS calibration. Set LC-GPA functions. Restore GET factory parameters if needed.

Controlla la diagnostica in tempo reale per verificare la tua moto. Controlla le ore della tua centralina. Calibra lo O-TPS. Imposta le funzionalità LC-GPA. Resetta i parametri di fabbrica GET in caso di necessità.



Choose among pre-installed different map configurations according to your riding needs.

Scegli fra differenti mappature pre-installate a seconda delle tue necessità di guida.



Create your own map configuration.

Crea la tua mappatura personalizzata

# 2ND INJECTOR KIT

2ND INJECTOR KIT - KIT SECONDO INIETTORE



The 2nd INJECTOR KIT has been developed to increase the performance on 250cc MX engines and to support the stock injector maximizing the engine power and improving drivability. The kit works with RX1 EVO and RX1 PRO ECUs and the dedicated map has to be downloaded for free from our web portal. All the installation parts are included in the kit together with the installation manual.

Il Kit Secondo Iniettore è stato studiato per aumentare le prestazioni dei motori MX 250cc e supportare il lavoro dell'iniettore originale, massimizzando la potenza della moto migliorandone la guidabilità. Il kit può essere abbinato a centraline RX1 EVO e RX1 PRO e funziona con una mappatura specifica, da scaricare gratuitamente dal nostro portale e caricare nella centralina. Il kit comprende inoltre tutti i collegamenti necessari per l'installazione e il manuale d'istruzioni.

## KEY BENEFITS

### PUNTI DI FORZA



**POWER  
MAXIMIZATION**  
MASSIMIZZAZIONE  
POTENZA



**OPTIMIZATION OF  
THE INJECTION**  
OTTIMIZZAZIONE  
DELL'INIEZIONE







**COMPLETE WITH  
INSTALLATION MANUAL**  
COMPLETO DI  
ISTRUZIONI MONTAGGIO  
DETTAGLIATE



**COMPATIBLE WITH  
ALL RX1 ECUs FOR 250s**  
COMPATIBILE CON TUTTE  
LE ECUs RX1 250cc

## APPLICATION LIST

## LISTA APPLICAZIONI

MODEL	APPLICATION	YEARS	P/N
	Honda 250 CRF R	2022 -2023	GK-INJ2-0020
	Yamaha 250 YZF	2021-2023	GK-INJ2-0019
	KTM SXF 250	2023	GK-INJ2-0021
	GASGAS MC250F	2021-2023	GK-INJ2-0017
	Husqvarna FC 250	2023	GK-INJ2-0021

For all applications please visit our web site [athena.eu](http://athena.eu)  
Visita il sito [athena.eu](http://athena.eu) per la lista applicazioni completa

This kit works only with GET ECUs. it doesn't work with stock/OEM ECUs  
Questo kit funziona solo con centraline GET. Non funziona con centraline originali

## DYNO POWER GRAPH

## CURVA DI POTENZA AL BANCO PROVA

## ECE Corrected Wheel Power vs. RPM

MX 250 19 OEM ECU vs MX 250 19 GET ECU + 2INJ

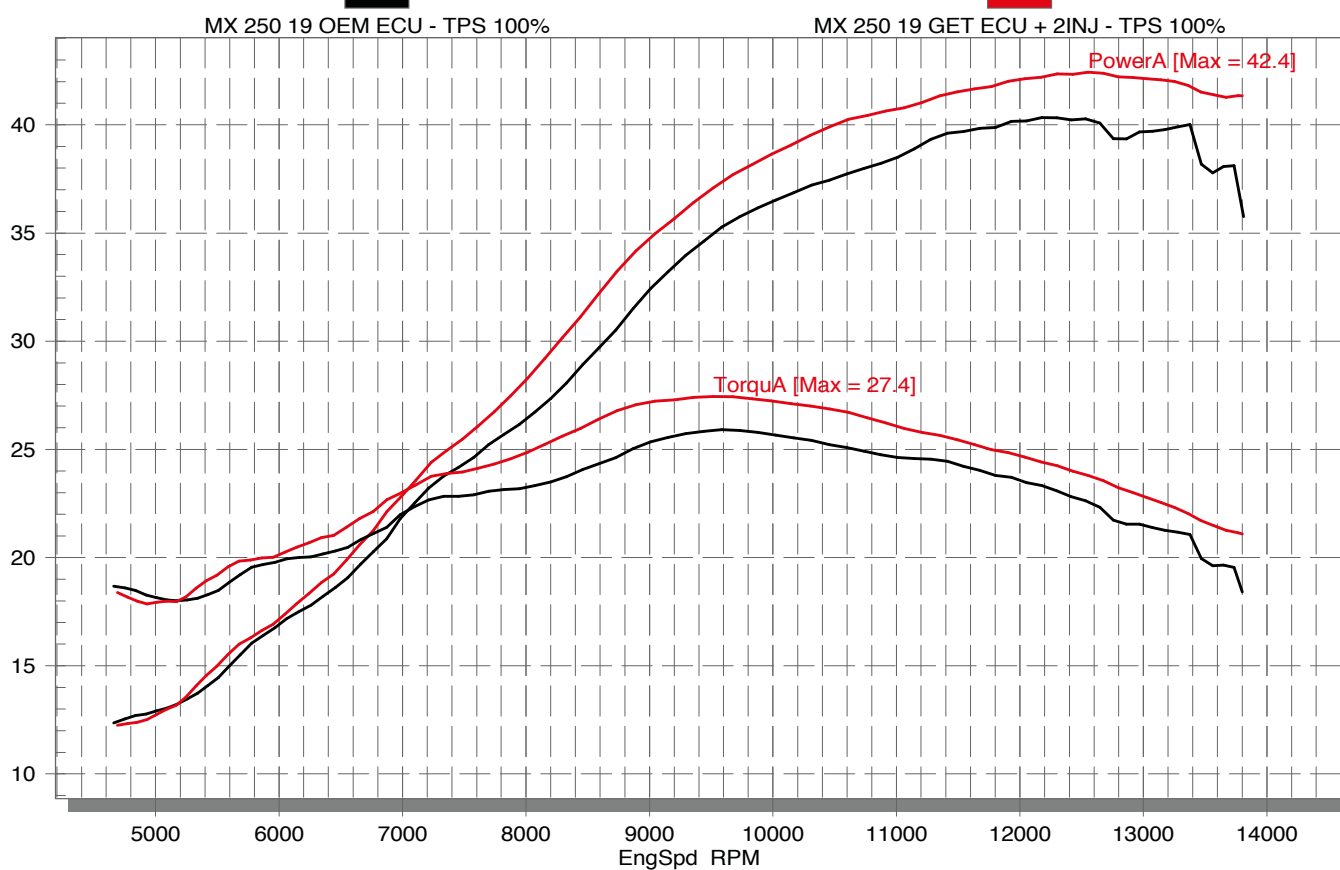





# **ROAD ENGINE CONTROL ENGINE CONTROL UNITS**

# WHAT GET OFFERS

## COSA OFFRE GET

LITHIUM BATTERIES AND BATTERY CHARGER



ENGINE CONTROL UNITS



QUICK SHIFTER KITS



JUMPSTARTER MINI



DATA LOGGING DEVICES

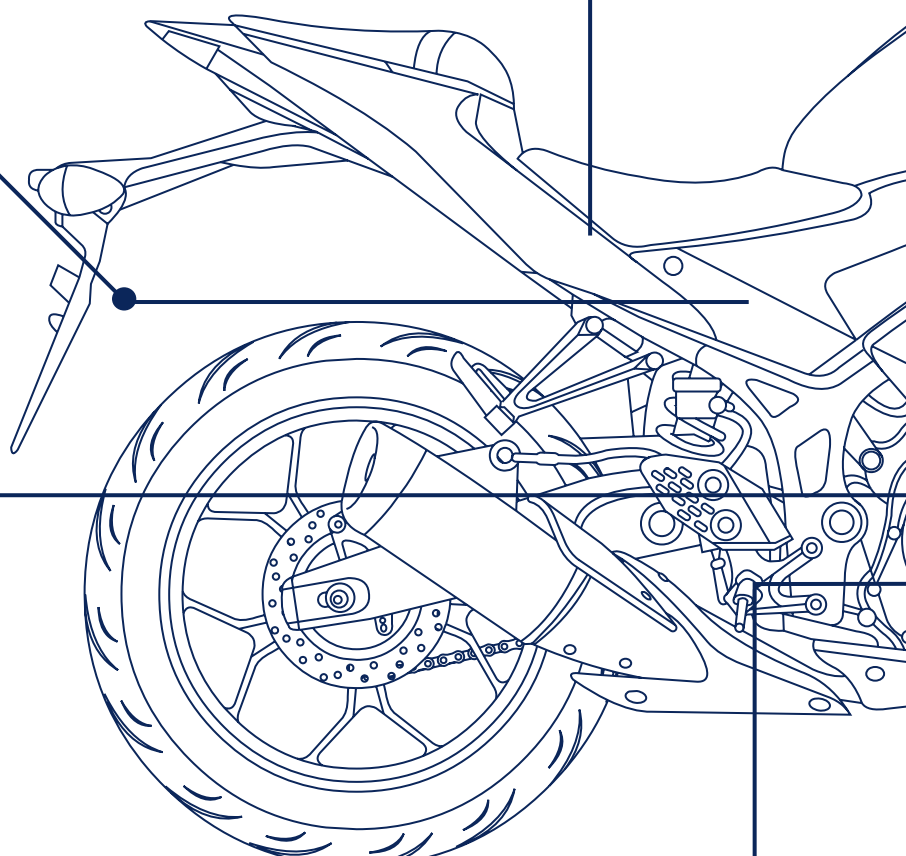

MAP SWITCH



DASHBOARD

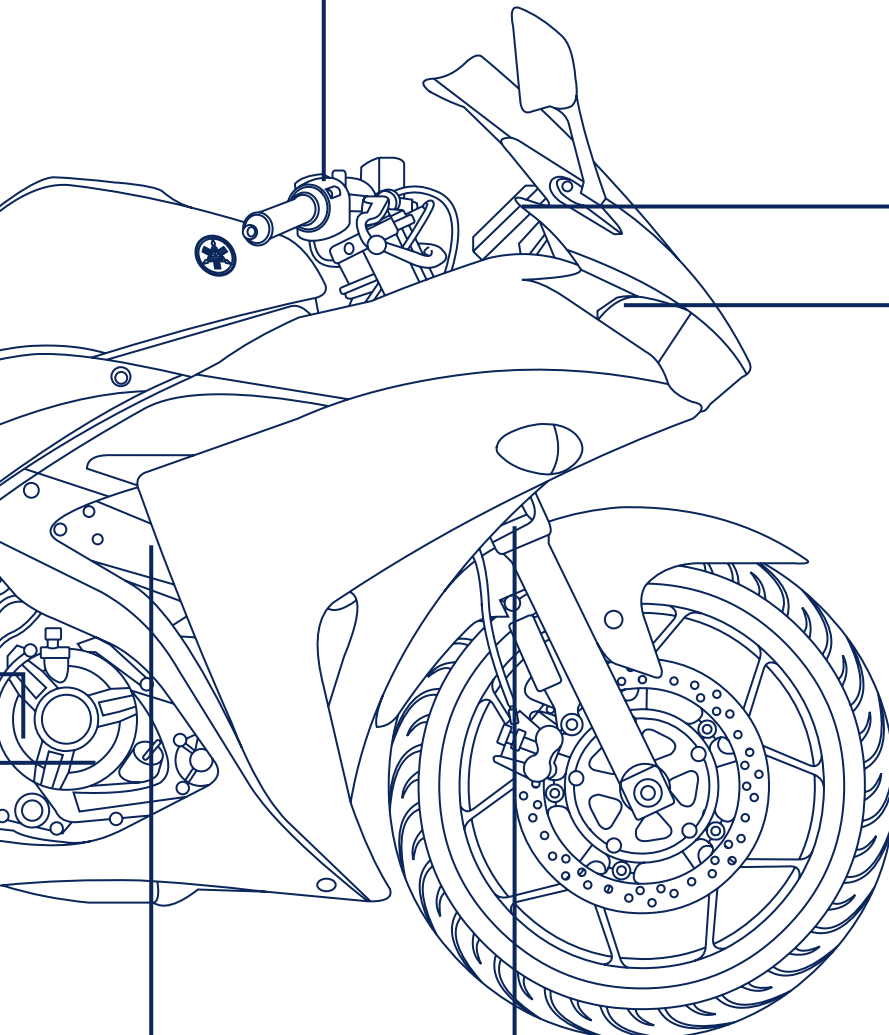

WIFI SETTING TOOL



POTENTIOMETER SENSORS





# ECULMB FOR YAMAHA R3/R25

ECU FOR YAMAHA R3/R25 - CENTRALINA MOTORE PER YAMAHA R3/R25



Wi Fi

MAP1 MAP2

**INCLUDED IN THE KIT**  
**INCLUSO NEL KIT**



MAP SWITCH

ECULMB is the ECU specifically developed for Yamaha R25/R3. Maximum performance and customization on your tuned engine are possible by connecting the unit to the Maya software (sold separately). Furthermore, two different ECU configurations can be selected: MAP1= dry; MAP2= wet.

ECULMB è la centralina espressamente sviluppata per la Yamaha R25/R3. Per personalizzare la centralina e ottenere le massime prestazioni dal tuo motore preparato, è sufficiente collegarla al software Maya (venduto separatamente). Inoltre, la centralina consente di scegliere tra due diverse configurazioni: MAP1= asciutto; MAP2= bagnato.

## KEY BENEFITS

### PUNTI DI FORZA



**2 PREINSTALLED  
RACING MAPS**  
 2 MAPPE RACING  
PREINSTALLATE



**REPROGRAMMABLE  
WITH MAYA SOFTWARE**  
 RIPROGRAMMABILE  
CON SOFTWARE MAYA



**PLUG & PLAY**  
 INSTALLAZIONE  
IMMEDIATA



**PROGRAMMABLE  
THROUGH APP**  
 PERSONALIZZABILE  
TRAMITE APP

## APPLICATION LIST

### LISTA APPLICAZIONI

MODEL	APPLICATION	YEARS	P/N
	<b>YAMAHA R25 (ASEAN)</b>	2015 - 2017	<b>GK-ECULMB48-0001</b>
	<b>YAMAHA R3</b>	2019	<b>GK-ECULMB48-0006</b>
	<b>YAMAHA R3 RACING CIV (FMI APPROVED)</b>	2019	<b>GK-ECULMB48-0007</b>
	<b>YAMAHA R3</b>	2018	<b>GK-ECULMB48-0005</b>
	<b>YAMAHA R3 RACING CIV (FMI APPROVED)</b>	2018	<b>GK-ECULMB48-0004</b>

For all applications please visit our web site [athena.eu](http://athena.eu)  
Visita il sito [athena.eu](http://athena.eu) per la lista applicazioni completa

## ADDITIONAL ACCESSORIES

### ACCESSORI AGGIUNTIVI



#### SL1 SMART LOGGER

The SL1 Data Acquisition System increases position accuracy thanks to its built-in GPS and Sensor Fusion Technology. BLE connectivity allows also wireless logging of biometric sensors such as Heart Rate sensor

Il sistema di Acquisizione Dati SL1 aumenta l'accuratezza della posizione grazie alla sua tecnologia Sensor Fusion Technology e al modulo GPS integrato. La connessione BLE permette inoltre l'acquisizione wireless di dati biometrici come un sensore cardio.



#### D30 EVO

D30 EVO is the dashboard developed by GET for motorsport applications. Thanks to its large backlit screen and alarm LEDs, the rider can display all data in a clear and effective manner during the ride.

D30 EVO è il cruscotto sviluppato da GET per rispondere alle esigenze del settore motor sport. Grazie all'ampio schermo retroilluminato e ai led di allarme, il pilota può visualizzare in pista tutti i dati in modo chiaro ed efficiente.



#### GK-WFCOM1-0003 - WiFi-COM

GET provides all riders with a smart device that allows the modification of the main engine parameters by simply using a smartphone or a tablet thanks to the WiGET app, available for iOS and Android systems.

GET fornisce a tutti i piloti un dispositivo che permette di modificare i principali parametri motore connettendo semplicemente il proprio Smartphone o Tablet al dispositivo WiFi-COM grazie all'app gratuita WiGET disponibile per sistemi iOS e Android.



#### QUICK SHIFTER

GET Quick Shifter is engineered to be used in road bikes and allows to change gear without throttle closing and without using the clutch.

Il cambio elettronico GET è studiato per le applicazioni stradali e consente l'inserimento delle marce senza chiudere il gas e senza utilizzare la frizione.

# ECUJ5 FOR KTM DUKE/RC

ECU FOR KTM DUKE/RC - CENTRALINA MOTORE PER KTM DUKE/RC



**INCLUDED IN THE KIT**  
**INCLUSO NEL KIT**



ADAPTOR  
HARNESS

MAP SWITCH

ECUJ5 is the ECU for KTM RC & DUKE. The kit includes the ECU, the harness and the Map 1 – 2 Switch. The maps have been developed to maximize the aftermarket Racing Exhaust System performance. This Plug&Play kit can be immediately installed with no modifications to the vehicle itself. Furthermore, by downloading the WiGET app on the smartphone, the engine map can be adjusted to any riding style.

ECUJ5 è la centralina per i modelli KTM RC & DUKE. Il kit comprende l'ECU, il cablaggio e il commutatore di mappe 1-2. Le mappe sono state sviluppate per migliorare le prestazioni del sistema di scarico Racing aftermarket. L'installazione del kit plug & play è immediata e non richiede alcuna modifica del veicolo. Inoltre, scaricando l'app WiGET sullo smartphone, è possibile adattare la mappa del motore a qualsiasi stile di guida.

## KEY BENEFITS PUNTI DI FORZA



**2 PREINSTALLED  
RACING MAPS**  
2 MAPPE RACING  
PREINSTALLATE





**PLUG & PLAY**  
INSTALLAZIONE  
IMMEDIATA



**PROGRAMMABLE  
THROUGH APP**  
PERSONALIZZABILE  
TRAMITE APP

## APPLICATION LIST

### LISTA APPLICAZIONI

MODEL	APPLICATION	YEARS	P/N
	<b>KTM DUKE 125</b>	2010-2015	<b>GK-ECJ5-0004</b>
	<b>KTM DUKE 200</b>	2011-2015	<b>GK-ECJ5-0006</b>
	<b>KTM DUKE 390</b>	2010-2016	<b>GK-ECJ5-0009</b>
	<b>KTM RC390</b>	2015	<b>GK-ECJ5-0010</b>

For all applications please visit our web site [athena.eu](http://athena.eu)  
 Visita il sito [athena.eu](http://athena.eu) per la lista applicazioni completa

## ADDITIONAL ACCESSORIES

### ACCESSORI AGGIUNTIVI



#### SL1 SMART LOGGER

The new SL1 Data Acquisition System increases position accuracy thanks to its built-in GPS and Sensor Fusion Technology. BLE connectivity allows also wireless logging of biometric sensors such as Heart Rate sensor

Il sistema di Acquisizione Dati SL1 aumenta l'accuratezza della posizione grazie alla sua tecnologia Sensor Fusion Technology e al modulo GPS integrato. La connessione BLE permette inoltre l'acquisizione wireless di dati biometrici come un sensore cardio.



#### GK-WF-COM1-0003 - WiFi-COM

GET provides all riders with a smart device that allows the modification of the main engine parameters by simply using a smartphone or a tablet thanks to the WiGET app, available for iOS and Android systems.

GET fornisce a tutti i piloti un dispositivo che permette di modificare i principali parametri motore connettendo semplicemente il proprio Smartphone o Tablet al dispositivo WiFi-COM grazie all'app gratuita WiGET disponibile per sistemi iOS e Android.



#### QUICK SHIFTER

GET Quick Shifter is engineered to be used in road bikes and allows to change gear without throttle closing and without using the clutch.

Il cambio elettronico GET è studiato per le applicazioni stradali e consente l'inserimento delle marce senza chiudere il gas e senza utilizzare la frizione.

# GP2 POWER FOR YAMAHA T-MAX

ECU POWER FOR YAMAHA T-MAX - CENTRALINA POWER PER YAMAHA T-MAX



**INCLUDED IN THE KIT**  
**INCLUSO NEL KIT**



ADAPTOR  
HARNESS

GP2 POWER - T-MAX is an ECU specifically developed for Yamaha T-MAX. Designed to maximize the performance of your standard engine with a racing exhaust.

GP2 POWER - T-MAX è una centralina espressamente sviluppata per Yamaha T-MAX. Sviluppata per massimizzare le performance del motore standard in abbinato ad uno scarico racing.

## KEY BENEFITS

### PUNTI DI FORZA



**POWER  
MAXIMIZATION**  
MASSIMIZZAZIONE  
POTENZA



**PLUG & PLAY**  
INSTALLAZIONE  
IMMEDIATA



**PROGRAMMABLE  
THROUGH APP**  
PERSONALIZZABILE  
TRAMITE APP

## ADDITIONAL ACCESSORIES

### ACCESSORI AGGIUNTIVI



#### GK-WFCOM2-0003 - WiFi-COM

GET provides all riders with a smart device that allows the modification of the main engine parameters by simply using a smartphone or a tablet thanks to the WiGET app, available for iOS and Android systems.

GET fornisce a tutti i piloti un dispositivo che permette di modificare i principali parametri motore connettendo semplicemente il proprio Smartphone o Tablet al dispositivo WiFi-COM grazie all'app gratuita WiGET disponibile per sistemi iOS e Android.

## APPLICATION LIST

### LISTA APPLICAZIONI

MODEL	APPLICATION	YEARS	P/N
	<b>YAMAHA T-MAX 500</b>	2008-2011	GK-GP2PWR-0001
	<b>YAMAHA T-MAX 530</b>	2012-2016	GK-GP2PWR-0002

For all applications please visit our web site [athena.eu](http://athena.eu)  
 Visita il sito [athena.eu](http://athena.eu) per la lista applicazioni completa



Photo: courtesy of yamahamotorsports.com

# GP2 EVO FOR YAMAHA T-MAX

ECU EVO FOR YAMAHA T-MAX - CENTRALINA EVO PER YAMAHA T-MAX



MAP1 MAP2

Wi Fi

INCLUDED IN THE KIT  
INCLUSO NEL KIT



ADAPTOR  
HARNESS

GP2 EVO - T-MAX is an ECU specifically developed for Yamaha T-MAX. Maximum performance and customization on your tuned engine are possible by connecting the unit to the Maya software. Furthermore, two different ECU configurations can be selected (MAP1 for bikes with standard exhaust and MAP2 for bikes with racing exhaust).

GP2 EVO - T-MAX è una centralina espressamente sviluppata per la Yamaha T-MAX. Per personalizzare la centralina e ottenere le massime prestazioni dal tuo motore preparato, è sufficiente collegarla al software Maya. Inoltre, la centralina consente di scegliere tra due diverse configurazioni (MAP1 per moto con scarico standard e MAP2 per moto con scarico da gara).

## KEY BENEFITS PUNTI DI FORZA



POWER  
MAXIMIZATION  
MASSIMIZZAZIONE  
POTENZA



REPROGRAMMABLE  
WITH MAYA SOFTWARE  
RIPROGRAMMABILE  
CON SOFTWARE MAYA



PLUG & PLAY  
INSTALLAZIONE  
IMMEDIATA



PROGRAMMABLE  
THROUGH APP  
PERSONALIZZABILE  
TRAMITE APP

## APPLICATION LIST LISTA APPLICAZIONI

MODEL	APPLICATION	YEARS	P/N
	<b>YAMAHA T-MAX 500</b>	2008-2011	<b>GK-GP2EVO-0001</b>
	<b>YAMAHA T-MAX 530</b>	2012-2016	<b>GK-GP2EVO-0002</b>

For all applications please visit our web site [athena.eu](http://athena.eu)  
Visita il sito [athena.eu](http://athena.eu) per la lista applicazioni completa

## ADDITIONAL ACCESSORIES ACCESSORI AGGIUNTIVI



### GK-WFCOM1-0003 - WiFi-COM

GET provides all riders with a smart device that allows the modification of the main engine parameters by simply using a smartphone or a tablet thanks to the WiGET app, available for iOS and Android systems.

GET fornisce a tutti i piloti un dispositivo che permette di modificare i principali parametri motore connettendo semplicemente il proprio Smartphone o Tablet al dispositivo WiFi-COM grazie all'app gratuita WiGET disponibile per sistemi iOS e Android.



### MAP SWITCH

This switch allows you to change engine behavior between two map configurations.

Il Map Switch GET è un dispositivo che consente di scegliere fra due differenti mappature.



Photo: courtesy of yamahamotorsports.com



# KM3 EVO FOR HONDA NSF 250R

ECU FOR HONDA NSF 250R - CENTRALINA MOTORE PER HONDA NSF 250R



KM3 EVO is a Plug&Play replacement ECU kit designed for Moto3 Honda NSF 250R in HRC configuration, including a specifically developed performance map. KM3EVO controls and manages fuel injection and ignition, interacting with the map to obtain the best engine performance. The connection to the bike is made through a specifically developed Plug&Play harness designed by GET for Honda, which ensures an easy installation. The additional analogue and digital inputs make it possible to control and to tune on specific Map tables and parameters such as pit limiter, launch control or stepper motor. A Data Logging system via CAN Bus can also be installed to analyze all relevant data (e.g. speed, engine RPM, TPS position, etc.).

Il kit KM3 EVO è una centralina sostitutiva Plug&Play progettata per la Moto3 Honda NSF 250R in configurazione HRC con nuova mappa prestazionale appositamente sviluppata. KM3 EVO controlla e gestisce l'iniezione di carburante e l'anticipo dell'accensione interagendo con la mappa per ottenere le migliori prestazioni del motore. Il collegamento alla moto viene facilmente eseguito utilizzando un cablaggio Plug&Play appositamente sviluppato da GET. Le entrate analogiche e digitali aggiuntive permettono di controllare e impostare specifici parametri e tabelle di mappatura come il limitatore, il launch control o il motorino passo passo. È inoltre possibile installare un sistema di registrazione dati tramite CAN bus per una successiva analisi (ad esempio, velocità, giri motore, posizione della valvola a farfalla, ecc.).

## KEY BENEFITS PUNTI DI FORZA



**POWER  
MAXIMIZATION**  
MASSIMIZZAZIONE  
POTENZA



**REPROGRAMMABLE  
WITH MAYA SOFTWARE**  
RIPROGRAMMABILE  
CON SOFTWARE MAYA



**PLUG & PLAY**  
INSTALLAZIONE  
IMMEDIATA



**PROGRAMMABLE  
THROUGH APP**  
PERSONALIZZABILE  
TRAMITE APP

## APPLICATION LIST LISTA APPLICAZIONI

MODEL	APPLICATION	P/N
	<b>HONDA NSF 250R (ECU + P&amp;P HARNESS)</b>	<b>GK-KM3EVO-0001</b>
	<b>HONDA NSF 250R (ECU ONLY)</b>	<b>GK-KM3EVO-0002</b>

For all applications please visit our web site [athena.eu](http://athena.eu)  
Visita il sito [athena.eu](http://athena.eu) per la lista applicazioni completa

## ADDITIONAL ACCESSORIES ACCESSORI AGGIUNTIVI



### GK-WFCOM2-0001 - WiFi-COM

GET provides all riders with a smart device that allows the modification of the main engine parameters by simply using a smartphone or a tablet thanks to the WiGET app, available for iOS and Android systems.

GET fornisce a tutti i piloti un dispositivo che permette di modificare i principali parametri motore connettendo semplicemente il proprio Smartphone o Tablet al dispositivo WiFi-COM grazie all'app gratuita WiGET disponibile per sistemi iOS e Android.



### MAP SWITCH

This switch allows you to change engine behavior between two map configurations.

Il Map Switch GET è un dispositivo che consente di scegliere fra due differenti mappature.



### 2nd INJECTOR KIT - only for 250cc

The 2nd INJECTOR KIT has been developed to increase the performance on 250cc MX engines and to support the stock injector maximizing the engine power and improving drivability.

Il Kit Secondo Iniettore è stato studiato per aumentare le prestazioni dei motori MX 250cc e supportare il lavoro dell'iniettore originale, massimizzando la potenza della moto migliorandone la guidabilità.



### SL1 SMART LOGGER

The SL1 Data Acquisition System increases position accuracy thanks to its built-in GPS and Sensor Fusion Technology. BLE connectivity allows also wireless logging of biometric sensors such as Heart Rate sensor

Il sistema di Acquisizione Dati SL1 aumenta l'accuratezza della posizione grazie alla sua tecnologia Sensor Fusion Technology e al modulo GPS integrato. La connessione BLE permette inoltre l'acquisizione wireless di dati biometrici come un sensore cardio.



### D30

D30 EVO is the dashboard developed by GET for motorsport applications. Thanks to its large backlit screen and alarm LEDs, the rider can display all data in a clear and effective manner during the ride.

D30 EVO è il cruscotto sviluppato da GET per rispondere alle esigenze del settore motor sport. Grazie all'ampio schermo retroilluminato e ai led di allarme, il pilota può visualizzare in pista tutti i dati in modo chiaro ed efficiente.



### QUICK SHIFTER

GET Quick Shifter is engineered to be used in road bikes and allows to change gear without throttle closing and without using the clutch.

Il cambio elettronico GET è studiato per le applicazioni stradali e consente l'inserimento delle marce senza chiudere il gas e senza utilizzare la frizione.





# ROAD ECU ACCESSORIES

# WiFi-COM

WIRELESS ECU CALIBRATION DEVICE

STRUMENTO WIRELESS DI SETTAGGIO CENTRALINA



WIGET APP



GET provides all riders with a smart device that allows the modification of the main engine parameters by simply using a smartphone or a tablet thanks to the WiGET app, available for iOS and Android systems. New customization possibilities are offered for the RX1 PRO ECUs such as additional map profiles, pre-installed by the GET engineers, for different track conditions or riding styles and mapping on specific brake-points

GET fornisce a tutti i piloti un dispositivo che permette di modificare i principali parametri motore connettendo semplicemente il proprio Smartphone o Tablet al dispositivo WiFi-COM grazie all'app gratuita WiGET disponibile per sistemi iOS e Android. GET offre possibilità ancora maggiori di personalizzazione per i modelli RX1 PRO poichè sarà possibile intervenire su specifici punti della mappa per applicare correzioni in tempo reale e i piloti troveranno dei profili preinstallati per provare immediatamente differenti settaggi di mappa.

## KEY BENEFITS PUNTI DI FORZA



**PLUG & PLAY**  
INSTALLAZIONE  
IMMEDIATA



**COMPATIBLE WITH  
ALL GET ECUS**  
COMPATIBILE CON  
TUTTE LE CENTRALINE GET



**REAL TIME DIAGNOSTIC  
AND ENGINE MANAGEMENT  
AVAILABLE**  
DIAGNOSTICA E MODIFICA  
I PARAMETRI MOTORE  
REALTIME



**PROGRAMMABLE  
THROUGH APP**  
PERSONALIZZABILE  
TRAMITE APP

## APPLICATION LIST LISTA APPLICAZIONI

APPLICATION	P/N
WiFi-COM for GP2-POWER	GK-WFCOM2-0003
WiFi-COM for ECULMB, ECUJ5, GP2-EVO	GK-WFCOM1-0003

For all applications please visit our web site [athena.eu](http://athena.eu)  
Visita il sito [athena.eu](http://athena.eu) per la lista applicazioni completa

## ADDITIONAL ACCESSORIES ACCESSORI AGGIUNTIVI



### GL-0170-AA Power Supply Cable for GET WiFi-COM

This cable allows to connect WiFi-COM to a fully charged 12V battery and power it up to map while the engine is off. This needs to avoid engine overheating while mapping.

Il cavo consente di alimentare il WiFi-COM tramite una batteria a 12 V e mappare mentre il motore è spento. Questo serve ad evitare un surriscaldamento del motore mentre si programma.



**WIDGET Free App** Available for iOS and Android (see page 66)  
**WIDGET Applicazione gratuita** Disponibile per iOS ed Android (vedi pagina 66)



Modify ignition timing and injection. Increase the limiter up to 500 RPM more than OEM. Gear-cut function for GET quick-shifter-equipped bikes.

Modifica anticipo e iniezione. Aumenta il limitatore fino a 500 giri in più dell'originale. Gestione tempi di cambiata per moto che montano il quick-shifter GET

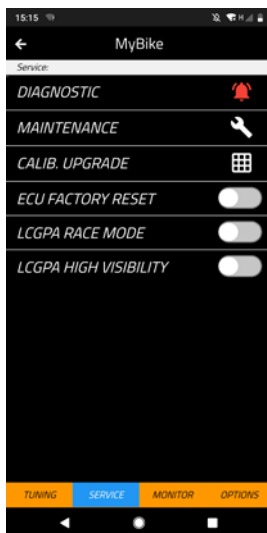

Check the diagnostics in real time to verify the status of your bike. Check the working hours of your ECU. Perform the 0-TPS calibration. Set LC-GPA functions. Restore GET factory parameters if needed.

Controlla la diagnostica in tempo reale per verificare la tua moto. Controlla le ore della tua centralina. Calibra lo 0-TPS. Imposta le funzionalità LC-GPA. Resetta i parametri di fabbrica GET in caso di necessità.



Create your own map configuration.

Crea la tua mappatura personalizzata

# D30 EVO

## DASHBOARD - CRUSCOTTO DATI



D30 EVO is the dashboard developed by GET for motorsport applications. Thanks to its large backlit screen and alarm LEDs, the rider can display all data in a clear and effective manner during the ride.

D30 EVO è il cruscotto sviluppato da GET per rispondere alle esigenze del settore motor sport. Grazie all'ampio schermo retroilluminato e ai led di allarme, il pilota può visualizzare in pista tutti i dati in modo chiaro ed efficiente.

### APPLICATION LIST

#### LISTA APPLICAZIONI

MODEL	P/N
Dashboard (custom applications)	GK-D30EVO1-0001
Dashboard for YAMAHA R25/R3	GK-D30EVO1-0002



# QUICK SHIFTER

## QUICK SHIFTER - CAMBIO ELETTRONICO



GET Quick Shifter is engineered to be used in road bikes and allows to change gear without throttle closing and without using the clutch.

Il cambio elettronico GET è studiato per le applicazioni stradali e consente l'inserimento delle marce senza chiudere il gas e senza utilizzare la frizione.

### APPLICATION LIST

#### LISTA APPLICAZIONI

MODEL	P/N
Quick shifter for YAMAHA R3/25 with COMPRESSION Sensor	GS-CAM-0007
Quick shifter for YAMAHA R3/25 with TRACTION Sensor	GS-CAM-0009
Quick shifter for KTM RC390 with COMPRESSION Sensor	GS-CAM-0007
Quick shifter for KTM RC390 with TRACTION Sensor	GS-CAM-0009
Quick shifter for NSF 250R with TRACTION Sensor	GS-CAM-0005
Quick shifter for NSF 250R with COMPRESSION Sensor	GS-CAM-0006

For all applications please visit our web site [athena.eu](http://athena.eu)  
 Visita il sito [athena.eu](http://athena.eu) per la lista applicazioni completa

# MAP SWITCH

## MAP SWITCH - SELETTORE DI MAPPA



Water and dirt-proof, this switch allows you to change engine map on the fly! It's suitable for all GET Road ECUs.

Il Map Switch GET è un dispositivo che consente di scegliere fra due differenti mappature in tempo reale.  
 Il Map Switch è compatibile con tutte le centraline GET per applicazioni stradali.







# **SOFTWARE & PROGRAMMING**

# PROGRAMMING TOOLS

## STRUMENTI DI PROGRAMMAZIONE

### WIDGET



WiGET is a free app which works with the WiFi-COM device to adjust in real time the main engine parameters of GET ECUs, directly from your smartphone or tablet. This app is available for iOS and Android.

WiGET è la app gratuita che, in abbinata con WiFi-COM, permette di modificare in tempo reale i principali parametri motore delle centraline GET direttamente dallo smartphone o tablet. La app è disponibile per dispositivi iOS e Android.

### MAYA PROGRAMMING SOFTWARE

#### SOFTWARE DI PROGRAMMAZIONE MAYA



MAYA is the software that allows the full configuration of GET ECUs. With this software, you can change any ECU parameter in real time and display all the values gaining total control over the working phases. Maya also allows the self-mapping that drastically reduces working time, saving engine life and making your job easier. Two versions of this software are available: EVO, as an entry level step, and ADVANCED as top level license.

Il software Maya consente la gestione completa delle centraline GET permettendo di modificare i parametri motore e ottenere dati utili alle sessioni di lavoro. Maya permette di impostare una mappatura personalizzata e integrare una serie di strumenti grazie ai quali si riducono drasticamente i tempi, aumentando la durata del motore e facilitando il lavoro. Il software Maya è disponibile in due diversi tipi di licenze: EVO, livello base, ed ADVANCED come livello massimo.

ENABLED FUNCTIONS	WiGET		EVO software license*	ADVANCED software license
	CODE	GK-WFCOM2-0001 GK-WFCOM2-0002 GK-WFCOM1-0003	PA00040000	PA00040001
WiFi technology		✓	X	X
Full map display of injection timing as "plain values"		X	X	✓
Injection correction on each breakpoint (on 768 map points)		X	✓ (+/-100%)	✓
Injection correction available across the whole map		✓ (-5% + 30%)	✓ (+/-100%)	✓ (+/-100%)
Injection correction for each breakpoint (on 30 map points)		✓	✓	✓
Map with ignition advance in plain		X	X	✓
Ignition timing correction for each breakpoint (on 768 map points)		X	✓ (+/-64°)	✓
Ignition timing correction for each breakpoint (on 30 map points)		✓	✓	✓
Ignition timing correction available across the whole map		✓ (-30° + 5°)	✓ (+/-64°)	✓
Injection angle		X	X	✓
Injection timing correction based on throttle derivative		X	X	✓
RPM limiter		✓ (max + 500rpm)	✓ (max + 500rpm)	✓
Strategic management of the RPM limiter cut-off time		X	X	✓
Personal password protection against ECU data access		X	✓	✓
Injection data correction based on engine temperature		X	X	✓
Injection data correction based on barometric pressure		X	X	✓
Injection data correction during crank		X	X	✓
Map breakpoint management		X	X	✓
Calibration of input signals from wheel speed sensors (optional)		X	X	✓
Quick shifter cut-off time management		✓	✓	✓
Lambda display and analysis		✓	✓	✓
Lambda display and analysis with linearization and target		✓	✓	✓
ECU diagnosis		✓	✓	✓
GPA "GET Power Assistance": select the operating level for dynamic power control		X	✓	✓
Real Time Data Display (Graph)		X	X	✓

\*These editable functions depend on the specific ECU model

\*Tali funzioni editabili dipendono dallo specifico modello di ECU

## MAYA EVO LICENCE SOFTWARE

code: PA00040000



The MAYA EVO programming kit includes the Maya software and the cable to connect the control unit to the PC. It allows installing customizing maps and modifying the main ECU parameter, like fuel and injection settings. Thanks to MAYA EVO, it is also possible to change the GPA assistance level.

Il kit di programmazione MAYA EVO comprende il software Maya e il cavo per collegare la centralina al PC. Permette di installare mappature differenti e di modificare i principali parametri motore, tra cui cambiare le impostazioni carburante e iniezione. Grazie a MAYA EVO è possibile anche variare il livello di assistenza GPA.

## MAYA ADVANCED LICENCE SOFTWARE

code: PA00040001



MAYA ADVANCED programming pack includes the Software, the ECU/PC connection cable plus a USB dongle. It allows changing the injection timing, the ignition, the injection phases, the throttle derivative, the RPM limiter and many other functions. Unlike the EVO license, the ADVANCED one allows displaying all GET preset values in plain. With Maya Advanced license you can also manage the 10 levels of GPA assistance and set up your own map configuration. Users will be able to pass from EVO to ADVANCED license with a specific USB Key provided by GET.

Il kit di programmazione MAYA ADVANCED comprende il software Maya con chiave di accesso hardware e il cavo di collegamento ECU/PC (porta seriale). Permette di modificare tempi di iniezione, anticipo, fase di iniezione, derivata farfalla, limitatore giri, tempi di taglio per il cambio elettronico e moltissime altre funzioni. A differenza della versione EVO, la licenza ADVANCED consente la visualizzazione in chiaro dei valori impostati. Con la licenza Maya Advanced è possibile gestire i 10 livelli di assistenza GPA e configurare la propria mappatura personale. Gli utenti potranno scegliere di passare dalla licenza Maya Evo a quella Advanced con una specifica chiavetta USB fornita da GET.

## ADDITIONAL ACCESSORIES

ACCESSORI AGGIUNTIVI



**GL-0163-AA**

**Programming Cable for GET 2T CDIs**

This cable allows the communication between MAYA and the GET 2T CDIs.  
Questo cavo permette la comunicazione fra MAYA e le centraline CDI 2T.

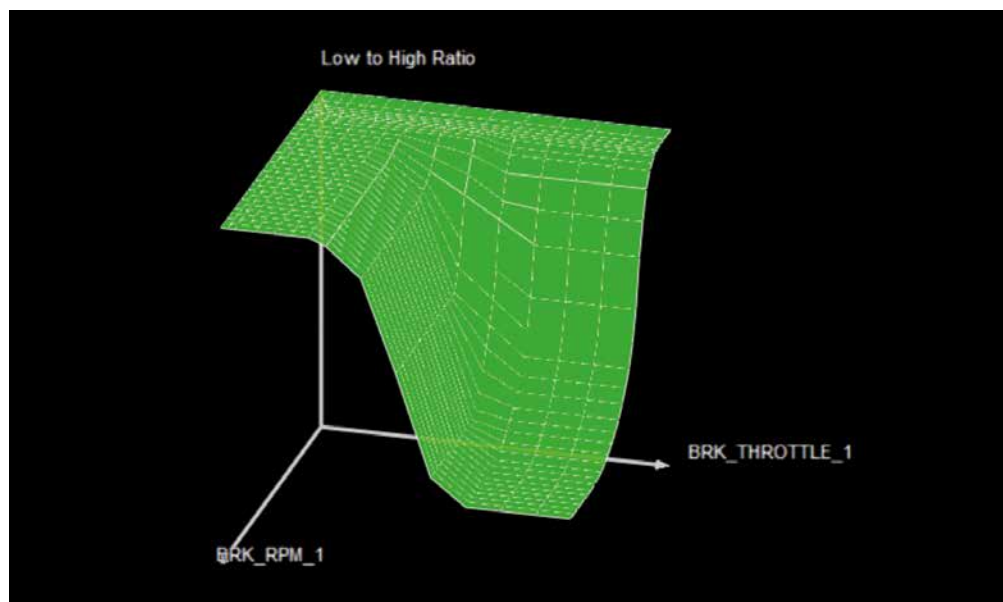

## MAYA SOFTWARE

3D VIEW



VIDEO TUTORIAL  
ENGLISH VERSION



VIDEO TUTORIAL  
ITALIAN VERSION

Photo: Lucio Buseilli - Overlook farm





# DATA ACQUISITION

# SL1 SMART LOGGER

**WIFI DATA ACQUISITION SYSTEM**  
SISTEMA DI ACQUISIZIONE DATI WIFI



**DATA ACQUISITION SYSTEM**  
SISTEMA DI ACQUISIZIONE DATI



**MODEL**

**P/N**

SL1 Smart Logger Wifi

GK-SL1-0001

SL1 Smart Logger

GK-SL1-0002

SL1 Smart Logger for Honda CBR 1000 RR-R (2020)

GK-SL1CBR-0001

## INCLUDED IN THE KIT

INCLUSO NEL KIT



GPS ANTENNA



MINI-USB CABLE



CABLE CONNECTOR  
BETWEEN SL1 AND  
GET ECUS



WinTAX4 - All Rights Reserved

WINTAX4 GET  
JUNIOR SOFTWARE



LYNXLOG GET  
SOFTWARE

The SL1 GET Data Logging System is the essence of technology. It is robust, light-weight and compact. The case is IP67 protection grade for the toughest riding conditions. Thanks to built-in GPS and Sensor Fusion Technology SL1 increases position accuracy. SL1 has been designed to expand standard data loggers connectivity. CAN-BUS communication enables data flow from ECU and/or sensors with only two wires while BLE allows wireless logging of biometric sensors such as Heart Rate. Thanks to the WiFi connection, device configurations and data download can be done fast and easily. SL1 logger comes with WINTAX4 GET "JUNIOR" analysis software.

Il Sistema di Acquisizione Dati GET SL1 è estremamente tecnologico, leggero e compatto. Il suo case ha un grado di protezione IP67 per resistere alle condizioni degli sport più estremi. Grazie alla tecnologia integrata GPS ed alla Sensor Fusion Technology, SL1 aumenta l'accuratezza della posizione. La comunicazione CAN-BUS permette di esportare dati dalla centralina e/o dai sensori utilizzando soltanto due cavi mentre la connessione BLE di acquisire, senza fili, sensori come quello cardio ad esempio. Grazie alla connessione WiFi infine, le configurazioni del dispositivo e lo scarico dati possono essere effettuati facilmente e velocemente. Il sistema SL1 è conclusivo del software di analisi WINTAX4 GET "JUNIOR".

## KEY BENEFITS

PUNTI DI FORZA



2 CAN BUS 2.0  
DUE PORTE CAN 2.0



EXPANDABLE IC AND  
AN INPUTS  
ESPANDIBILE A PIÙ  
INPUT IC E AN



BLUETOOTH  
CONNECTIVITY FOR  
EXTERNAL DEVICES  
CONNETTIVITÀ  
BLUETOOTH CON  
SENSORI ESTERNI



WATER AND DUST  
RESISTANT  
IMPERMEABILE E  
RESISTENTE ALLO  
SPORCO



BUILT-IN GPS  
MODULO GPS  
INTEGRATO

## MAIN FEATURES

### CARATTERISTICHE PRINCIPALI

#### ELECTRICAL SPECIFICATIONS

MAIN POWER SUPPLY INLET	9- 18 VDC
OPTIONAL POWER SUPPLY INLET	5 VDC (mini USB port)
AUXILIARY OUTPUT VOLTAGE (FOR EXT. SENSORS POWER SUPPLY)	5VDC - 70mA max.

#### SYSTEM SPECIFICATIONS

BUILT-IN BACKUP BATTERY	3.7VDC rechargeable LiOn Battery
BUILT- IN MEMORY	7 GB Flash
SYSTEM CLOCK	Built in Real Time Clock (RTC)
BUILT IN GPS CHARACTERISTICS	Sensitivity: 167dB - Update rate:10Hz with ext active antenna
SYSTEM BUILT-IN SENSORS	9-axis Inertial platform
GPS LED STATUS	✓
SYSTEM LED STATUS	✓
LOGGING LED STATUS	✓
GPS ANTENNA CONNECTOR	SMA
CASE TYPE	Plastic Case PA6-GF30 (30% Glass Reinforced, Heat Stabilized, Flame Retardant)
CASE DIMENSIONS	21mm x 62mm x 79mm (without harness and GPS connector)
WEIGHT	≈170g
IP GRADE	IP 67
FIRMWARE UPDATES	✓

#### HARNESS SPECIFICATIONS

SL1 MAIN CABLE	9 poles HRS connector (DF62W-9EP-2.2C) – cable length: 150mm
SL1 EXPANSION CABLE	8 poles JST connector (08T-JWPF-VSLE-D) – cable length: 150mm
SL1 USB CABLE	Sealed Mini USB connector – cable length 500mm

#### STANDARD INPUT PORT SPECIFICATIONS

ANALOG SIGNAL INPUT	3 analog input port (signal range 0-5V)
FREQUENCY INPUT	1 frequency input (frequency range: 0-20kHz)

#### DATA BUS SPECIFICATIONS

CAN PORT	2x High Speed 2.0 ports (125 – 250- 500 kb/s, 1Mb/s)
----------	--

#### CONNECTIVITY

USB 2.0 PORT	✓
BLE	✓
WIFI	✓

#### SOFTWARE:

DESKTOP SOFTWARE	LinxLog & WinTAX4 Analysis Software
------------------	-------------------------------------

## ADDITIONAL ACCESSORIES

### ACCESSORI AGGIUNTIVI



WinTAX4 - All Rights Reserved

#### WINTAX4 GET USER

WinTAX4 is a complete suite of data analysis tools developed to show vehicle and engine behaviors data, acquired from Data Loggers.

WINTAX4 è un pacchetto completo di strumenti per l'analisi dati che permette di visualizzare parametri di comportamento del motore e del veicolo acquisiti dai dispositivi GET.



# WINTAX4 GET BY MAGNETI MARELLI

## DATA ANALYSIS SOFTWARE - SOFTWARE DI ANALISI DATI

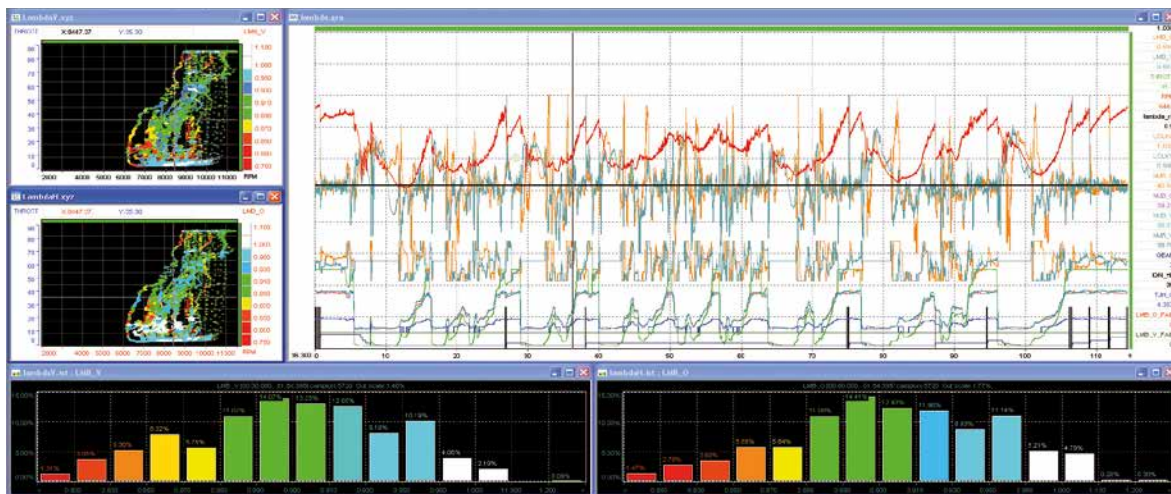

WinTAX4 is a complete suite of data analysis tools developed for the most advanced levels of motorsport. Especially engineered for GET users, WinTAX4 GET shows vehicle and engine behaviors data, acquired from Data Loggers. This high-end tool allows researching and development of most complete and complex vehicles! The software also presents an intuitive interface with graphic display, reports, histograms, overlay on videos and Google Earth with low system resources

WINTAX4 è un pacchetto completo di strumenti per l'analisi dati sviluppato per i più avanzati livelli di motorsport. Studiato appositamente per gli utenti GET, WinTAX4 GET permette di visualizzare parametri di comportamento del motore e del veicolo, acquisiti dai dispositivi GET. Il sistema trasmette grafici telemetrici in tempo reale per mezzo di una rete per gestire il flusso dati e analizzarlo. Il software presenta anche un'interfaccia intuitiva con grafici, report, istogrammi, sovrapposizioni con video e Google Earth con basso utilizzo di risorse di sistema.

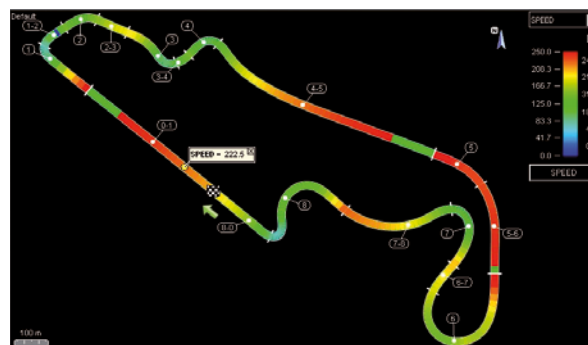

**MODEL**

WINTAX4 GET JUNIOR

WINTAX4 GET USER

**P/N**

GK-WINTAX-0002

GK-WINTAX-0001

# FEATURE COMPARISON

## CONFRONTO CARATTERISTICHE



WinTAX4 - All Rights Reserved



WinTAX4 - All Rights Reserved

**FEATURE:**

SOFTWARE INSTALLATION / RUNNING	UNPROTECTED – SINGLE WORKSTATION	Multi workstation - require USB Dongle
MULTI LANGUAGE SUPPORT	Only English	✓ (ENG-ITA-DEU-FRA-JAP)
GRAPH	2 Graph, 16 Channels each one	Unlimited
X-Y GRAPH	1 XY, two channels	Unlimited
XYZ GRAPH	X	✓
HISTOGRAM	1	✓
TRACK	basic track line	✓
MULTIPLE LAPS COMPARISON	Max. 2 Laps	✓
DIFFERENCE MODE LAPS COMPARISON	X	✓
GOOGLE EARTH TRACK OVERLAY	✓	✓
SECTION TIME REPORT	X	✓
LAP REPORT	Single Lap Only	✓
CHANNEL TREND FUNCTION	X	✓
SESSION RUN PREVIEW	✓	✓
DIAGNOSTIC GRAPH	X	✓
GAUGE INDICATORS	X	✓
CHANNEL ALARMS	✓	✓
CHANNEL EVENTS	X	✓
FFT WINDOW	X	✓
MATH CHANNELS	8 Max.	✓
LOOKUP TABLE	X	✓
FFT - RUN AVG FILTERS	X	✓
ASCII IMPORT	X	✓
ASCII EXPORT	X	✓
VIDEO-DATA MANAGEMENT	✓	✓



# MAGNETOSTRICTIVE SENSOR

## MAGNETIC POTENTIOMETER - POTENZIOMETRO MAGNETICO



A sensor for both front and rear suspensions, made with carbon case\*. This sensor works with a magnetic contactless part, which reduces mechanical wear. The GET-branded linear position transducer is a magnetic potentiometer made of an active part and a reference cursor. It is used for logging any linear shifting, ideal for suspensions for instance. Thanks to its specific structure, it is less subject to mechanical wear, unlike standard resistive potentiometers.

\*Mounts are not supplied.

Uno strumento per entrambe le sospensioni, composto da un case in carbonio\*. Questo sensore è contactless e funziona con un meccanismo magnetico che evita l'usura. Il sensore di posizione lineare GET è un potenziometro magnetico composto da una parte sensibile e da un cursore. Il sensore è adatto alla rilevazione dello spostamento lineare, come le sospensioni. Grazie alla particolare struttura interna esso non è soggetto all'usura meccanica che caratterizza i normali sensori a potenziometro resistivi.

\* Fornito senza supporti di fissaggio.

MODEL	P/N
MAGNETIC POTENTIOMETER (150 mm)	GK-MGNSTR-0002*
MAGNETIC POTENTIOMETER (350 mm)	GK-MGNSTR-0003*

\* Part numbers when used with the SL1 Smart Logger

\* Codici usati per l'utilizzo con SL1 Smart Logger

### OTHER SENSORS

#### ALTRI SENSORI



NTC TEMPERATURE SENSOR  
(M6) -20 +130  
P/N: DS00050000

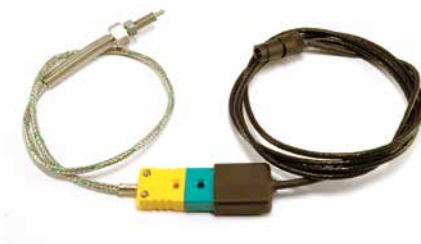

K-TYPE THERMOCOUPLE  
-20 +900  
CODE: GE-TEM-0002



PONTENTIOMETER SENSOR  
CODE: DS00010001 100 MM  
DS00010002 150 MM

For the complete list of sensors see [athena.eu](http://athena.eu)  
Consulta la lista completa dei sensori su [athena.eu](http://athena.eu)

# LC1-PRO LAMBDA

## LAMBDA KIT - KIT LAMBDA



The LC1-PRO is a Lambda kit used to measure the proportion of oxygen in the exhaust gas; a mandatory tool to measure the best air/fuel ratio combustion. The kit includes the Lambda Wide Band Sensor connected to the LC1-PRO conditioning unit which sends data to the logging systems or to the Engine Control Unit. In presence of many cylinders you can connect several LC1 devices simultaneously. With its light weight and small size, LC1-PRO device can be easily fitted without any battery in all battery-less applications such as off-road bikes.

LC1-PRO è un kit Lambda sviluppato da GET che verifica i valori di ossigeno presenti nei gas di scarico, valore indispensabile per la verifica della carburazione e per la ricerca della migliore combustione e quindi della massima potenza. Il kit è composto dal sensore Lambda Wide Band collegato al dispositivo LC1-PRO per il condizionamento del segnale e l'invio diretto dei dati agli strumenti di acquisizione o alla centralina gestione motore. Nelle applicazioni con più cilindri è possibile collegare più dispositivi LC1 contemporaneamente. Leggero e di piccolissime dimensioni, il dispositivo LC1-PRO può essere montato facilmente senza batterie in tutte le applicazioni batteryless, come le moto off road da competizione.

### APPLICATION LIST LISTA APPLICAZIONI

MODEL	P/N
KIT LAMBDA LC1-PRO - MOTORSPORT APPLICATIONS	GK-LC1PRO-0004
KIT LAMBDA LC1-PRO - GENERAL APPLICATIONS	GK-LC1PRO-0005



Photo: Lucio Buselli - Overlook Team



# **SMART TOOLS**

# RPM DASH

RPM DISPLAY WITH SHIFT LIGHT & LAUNCH CONTROL SYSTEM

CONTAGIRI CON LUCE DI CAMBIATA E SISTEMA LAUNCH CONTROL



DISCOVER MORE  
SCOPRI DI PIÙ



WATCH THE VIDEO  
GUARDA IL VIDEO



MODE BUTTON



BRACKET

INCLUDED IN THE KIT  
INCLUSO NEL KIT

RPM Dash is the brand new GET device, totally compatible with the OE components of the bike, that allows to have always a great start, to keep under control the RPM level and to know when it's time to shift up.

The button on the handlebar (included) allows to set the optimal RPM level you wish to reach just before the start. Once all the LEDs turn on, you are ready to release the clutch and jump out of the gate. LEDs will also let you know exactly at which RPM level you are riding at any moment, for the full control of your bike. As you hit the shift threshold (settable with the button), the LEDs will flash, helping you to understand it's the right moment to shift up and unleash your engine at full power.

RPM Dash è il nuovissimo dispositivo GET, totalmente compatibile con i componenti originali della moto, che consente di avere sempre un'ottima partenza, di tenere sotto controllo il livello di giri motore e di sapere quando è il momento di cambiare marcia.

Il pulsante sul manubrio (incluso) consente di impostare il livello RPM ottimale da raggiungere appena prima della partenza. A LED tutti accesi, si è pronti per rilasciare la frizione e saltare fuori dal cancello. I LED permettono anche di sapere il livello RPM in tempo reale ed avere così il pieno controllo della moto. Una volta raggiunta la soglia di cambiata (impostabile con il pulsante), i LED lampeggeranno per segnalare che è il momento giusto per cambiare marcia e rilasciare la piena potenza del motore.

## KEY BENEFITS

### PUNTI DI FORZA



COMPATIBLE WITH ALL  
STOCK BIKES  
COMPATIBILE CON  
TUTTE LE PRINCIPALI  
APPLICAZIONI



EASY INSTALLATION  
INSTALLAZIONE  
IMMEDIATA



TOUGH DESIGN:  
WATER, MUD AND  
STONE PROOF  
RESISTENTE AD  
ACQUA, FANGO E  
GHIAIA



LAUNCH CONTROL  
MODE  
MODALITÀ LAUNCH  
CONTROL









RPM MODE DISPLAY  
MODALITÀ CONTAGIRI



SHIFT LIGHT  
LUCE DI CAMBIATA

**APPLICATION LIST**  
**LISTA APPLICAZIONI**

MODEL	APPLICATION	YEARS	P/N
	Honda 250 CRF R	2018 - 2023	GK-RPMDASH-0000
	Honda 450 CRF R	2017 - 2020	GK-RPMDASH-0000
	Suzuki 250 RMZ	2019 - 2023	GK-RPMDASH-0003
	Suzuki 450 RMZ	2018 - 2023	GK-RPMDASH-0003
	Kawasaki 250 KX	2018 - 2023	GK-RPMDASH-0002
	Kawasaki 450 KX	2019 - 2023	GK-RPMDASH-0002
	Yamaha 250 YZF	2019 - 2023	GK-RPMDASH-0002
	Yamaha 450 YZF	2010 - 2022	GK-RPMDASH-0002
	KTM SX-F 250	2016 - 2023	GK-RPMDASH-0001
	KTM SX-F 350	2016 - 2023	GK-RPMDASH-0001
	KTM SX-F 450	2016 - 2023	GK-RPMDASH-0001
	GASGAS MC250F	2021-2023	GK-RPMDASH-0001
	GASGAS MC450F	2021-2023	GK-RPMDASH-0001
	Husqvarna FC 250	2016 - 2023	GK-RPMDASH-0001
	Husqvarna FC 350	2016 - 2023	GK-RPMDASH-0001
	Husqvarna FC 450	2016 - 2023	GK-RPMDASH-0001







**ARE YOU READY TO CRUSH YOUR RIVALS?  
SEI PRONTO A BATTERE I TUOI AVVERSARI?**

## **LAUNCH CONTROL MODE MODALITÀ LAUNCH CONTROL**

Set the optimum RPM level you wish to achieve a great start. Use the LED lights to help you know how much to open or close the throttle before the start.

**LEDs fully on.... As the gate drops, release the clutch and grab the holeshot!**

Imposta il livello di giri motore ottimale che desideri raggiungere per ottenere una partenza ottimale. Fatti aiutare dalle luci a LED per capire quanto aprire o chiudere il gas prima della partenza.

**A LED completamente accesi... Giù il cancello, lascia la frizione e conquista l'holeshot!**



**CHECK THE RPM  
CONTROLLA GLI RPM**

## **REV COUNTER MODE MODALITÀ CONTAGIRI**

Get to know your bike better and check your RPM level in real time!

**The super bright LEDs let you know exactly at which RPM level you are riding at any moment.**

Impara a conoscere meglio la tua moto e controlla in tempo reale i giri motore!

**I LED luminosi funzionano da contagiri e ti aiutano a mantenere costantemente sotto controllo la tua moto.**



**CHOOSE THE RIGHT GEAR  
SCEGLI LA MARCIA GIUSTA**

## **SHIFT LIGHT LUCE DI CAMBIATA**

Just think it over: shifting up at the right time means better acceleration, using the full power of your engine and maximizing your performance!

**With the brand new GET RPM Dash, you can customize the optimal RPM level when you will understand it's the right time to shift up! Once you reach the desired threshold, the LEDs will flash, indicating the ideal moment to shift up.**

C'è poco da dire: effettuare al momento giusto la cambiata significa innanzitutto una migliore accelerazione, sfruttare tutta la potenza del tuo motore e massimizzare la performance!

**Con il nuovo RPM Dash di GET, puoi personalizzare il livello di giri motore in cui ti verrà indicato di cambiare marcia! Una volta raggiunta la soglia desiderata, i LED lampeggeranno, segnalando il momento ideale in cui effettuare le cambiate.**



# SMART SOS

SETTABLE SOS ALARM AND WIRELESS HOUR METER  
ALLARME SOS PROGRAMMABILE E CONTAORE WIRELESS



smartsos.athena.eu

DISCOVER MORE  
SCOPRI DI PIÙ



GET SMART SOS

FREE APP AVAILABLE FOR  
IOS AND ANDROID, TO USE  
ALL THE DEVICE FEATURES

APP GRATUITA  
DISPONIBILE PER IOS E  
ANDROID PER SBLOCCARE  
TUTTE LE FUNZIONALITÀ



"GET SMART SOS" APP FEATURES  
FUNZIONALITÀ DELL'APP "GET SMART SOS"

Smart SOS is the innovative tool which is both a wireless engine hour meter and a settable SOS alarm. Via the free GET Smart SOS app, available for iOS and Android, it is possible to record customised service intervals of the vehicles, in order to keep the bikes at the highest level of efficiency and performance, as well as tracking total and partial counts. Featuring an internal accelerometer which detects when the bike falls, this device sends a SOS notification with the GPS location to your preferred contacts chosen through the app. Smart SOS is equipped with a CR2032 replaceable battery, and it can be installed directly on the frame without needs of cables or sensors. It is also resistant to water, mud and dirt.

Smart SOS è l'innovativo strumento che funziona sia da contaore wireless sia da allarme SOS programmabile. Grazie all'app gratuita GET Smart SOS, disponibile per iOS e Android, è possibile registrare intervalli personalizzati di manutenzione dei propri veicoli, in modo da mantenere le moto sempre efficienti e al massimo delle prestazioni, così come visualizzare le ore totali e parziali. Dotato di un accelerometro interno che percepisce le cadute, il dispositivo invia una notifica di SOS con le coordinate GPS ai tuoi contatti scelti tramite l'app. Smart SOS integra una batteria CR2032 sostituibile e si applica direttamente al veicolo, senza necessità di collegare cavi o sensori. È inoltre resistente ad acqua, fango e sporco.

MODEL	P/N
SMART SOS	GK-GETHM-0001

## KEY BENEFITS PUNTI DI FORZA



PROGRAMMABLE  
THROUGH APP  
PERSONALIZZABILE  
TRAMITE APP



CRASH SOS ALARM  
ALLARME SOS CADUTE



SERVICE ALARM  
ALLARMI  
MANUTENZIONE



IP 67 CERTIFIED  
CERTIFICATO IP 67



INSTALLATION  
WITHOUT CABLES  
INSTALLAZIONE  
SENZA FILI



EQUIPPED WITH A  
CR2032 REPLACEABLE  
BATTERY  
DOTATO DI BATTERIA  
CR2032 SOSTITUIBILE

**APP FUNCTIONS**  
**FUNZIONALITÀ APP**

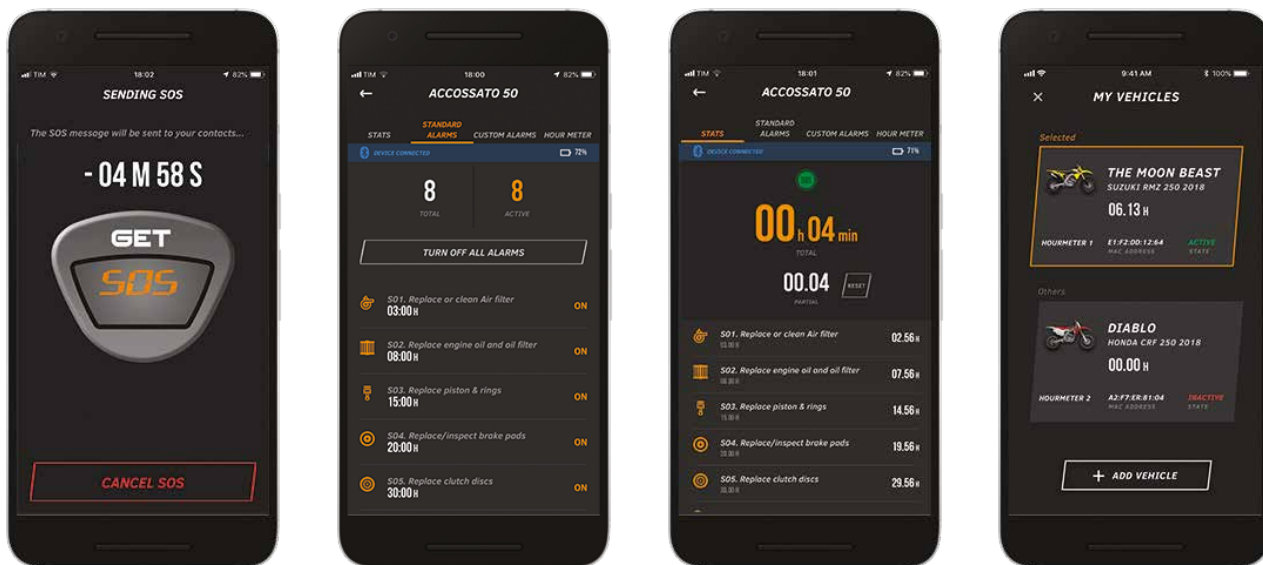

1. **SOS:** The App sends notifications to the registered contact.
2. **SERVICE:** The App records customised maintenance intervals in order to keep the bike at the highest level of efficiency and performance.
3. **HOUR METER FUNCTION:** The App shows total or partial counts and allows to set the device sensitivity.

1. **FUNZIONE SOS:** Tramite app è possibile attivare la funzione SOS, che invierà una richiesta di soccorso ai contatti registrati.
2. **FUNZIONE SERVICE:** sarà possibile inserire intervalli di manutenzione personalizzati, in modo da avere la moto sempre a punto.
3. **FUNZIONE CONTAORE:** la app consente di visualizzare gli intervalli parziali e le ore totali di utilizzo, così come regolare la sensibilità del dispositivo.



Photo by Lucio Buselli

# HOUR METER

VIBRATION SENSITIVE HOUR METER - CONTAORE SENSIBILE ALLE VIBRAZIONI



Hour Meter is the innovative GET engine hour meter. By using the supplied double side tape, Hour Meter fits to the bike in just a few seconds. By interpreting the vibrations on the frame on which it is applied, Hour Meter detects motor operation by discriminating casual vibrations from those given off by an activated motor. The Hour Meter device is completely waterproof and designed to work even in the most extreme conditions. Hour Meter has two meters: one with the resettable partial count and the other records the total hours of operation.

New features include:

- Lock Mode: to stop total and partial count
- Vibration Sensitivity Adjustment (High / Low)

The battery is integrated and guarantees operation for six years\*.

\* Average battery life calculated on MX riding.

Hour Meter è l'innovativo strumento conta ore motore di GET. Utilizzando l'adesivo in dotazione Hour Meter si applica in pochi secondi. Interpretando e distinguendo le vibrazioni presenti sul telaio sul quale viene applicato, Hour Meter rileva il funzionamento del motore distinguendo le vibrazioni casuali da quelle caratteristiche del motore avviato. Il dispositivo Hour Meter è completamente stagno ed è studiato per funzionare anche nelle applicazioni più estreme. Hour Meter ha due contatori: uno con il conteggio parziale resettabile, l'altro con il conteggio delle ore di funzionamento totali.

Fra le nuove funzionalità:

- Lock Mode: per poter fermare i conteggi totali e parziali
- Regolazione della sensibilità alle vibrazioni (Alta / Bassa)

La batteria è integrata e garantisce il funzionamento per sei anni\*\*.

\*\* Durata media calcolata con utilizzo della moto in ambito Motocross.

MODEL	P/N
HOUR METER	GK-GETHM-0002

## KEY BENEFITS

### PUNTI DI FORZA



ADJUSTABLE  
SENSITIVITY  
SENSIBILITÀ  
REGOLABILE



TOTAL AND PARTIAL  
COUNT  
POSSIBILITÀ DI  
CONTEGGIO SIA TOTALE  
CHE PARZIALE



IP66 + IP67 DUST AND  
WATER RESISTANT  
IP66 + IP67, RESISTENTE  
A POLVERE E ACQUA



6-YEAR LIFETIME  
BATTERY  
DURATA BATTERIA  
6 ANNI



LOCK MODE  
POSSIBILITÀ DI BLOCCO  
E SBLOCCO CONTATORI



Photo: Lucio Buselli - Overlook farm

# WiFi-COM HONDA CRF

WIFI TUNING TOOL FOR HONDA ECU

STRUMENTO WIFI DI SETTAGGIO ECU HONDA ORIGINALE



WIDGET APP



WiFi-COM is a tuning tool developed in close partnership with Honda for CRF machines. It allows you to work on both CRF 250 and 450's stock ECUs, starting from 2013 models on, by using your Smartphone and/or Tablet. This high tech device comes with Plug&Play connectors to be plugged straight on the standard diagnostic/fuel pump connection and allows to safely modify fuel and ignition parameters of your CRF factory maps. WiFi-COM gives you the possibility to modify the overall map as well as specific break points (RPM: 12; TPS: 18).

WiFi-COM è un dispositivo studiato in stretta collaborazione con Honda per i modelli CRF. È stata sviluppata per lavorare con le centraline standard dai modelli 2013 in poi, sia della 250 che della 450. Questo dispositivo altamente tecnologico è dotato di connettori Plug&Play per essere collegato alla diagnostica e alla pompa della benzina e permette di modificare in tutta sicurezza i parametri iniezione e accensione delle mappe di serie. Infine, WiFi-COM dà la possibilità di modificare non solo la mappatura intera, ma anche specifici parametri. La app WiGET offre la possibilità di scegliere la grafica preferita fra quella standard Honda e quella GET.

MODEL	P/N
WiFi-COM HONDA CRF	GK-WFCOM2-0002

## KEY BENEFITS

### PUNTI DI FORZA



**PLUG & PLAY**  
INSTALLAZIONE  
IMMEDIATA



**WORK ON CFR'S  
STOCK ECU**  
COMPATIBILE CON LE  
CENTRALINE HONDA  
CRF ORIGINALI



**REAL TIME DIAGNOSTIC  
AND ENGINE MANAGEMENT  
AVAILABLE**  
DIAGNOSTICA E MODIFICA  
I PARAMETRI MOTORE  
REAL TIME



**PROGRAMMABLE  
THROUGH APP**  
PERSONALIZZABILE  
TRAMITE APP



**OFFICIAL HONDA  
LAYOUT**  
LAYOUT HONDA  
UFFICIALE



**WIGET Free App** Available for iOS and Android (see page 66)  
**WIGET Applicazione gratuita** Disponibile per iOS ed Android (vedi pagina 66)

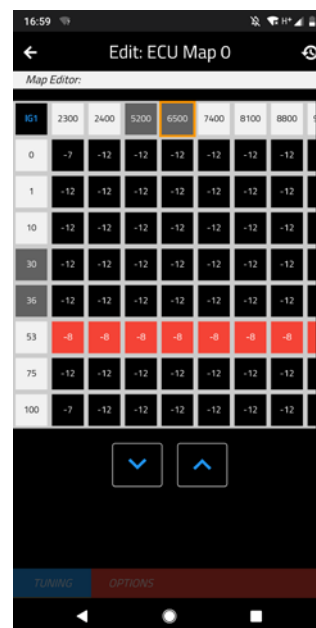
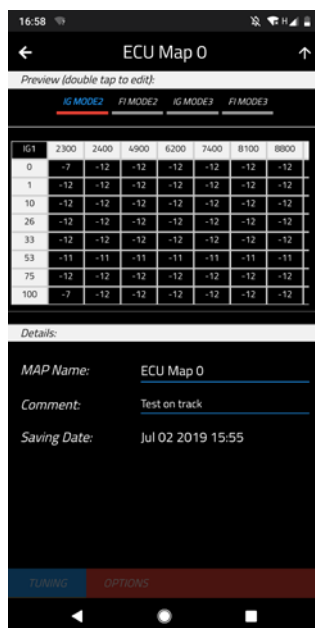

Manage your data profiles, receiving, creating and editing them through your main dashboard.  
 Get the perfect set-up for your need and/or track conditions.

Possibilità di gestire i profili di mappa, ricevendoli, creandoli ed editandoli attraverso il pannello principale, ottenendo il set up perfetto in base alle esigenze e alle condizioni del tracciato.

Choose which of the 2 MODES out of the 3 available (MODE2 & MODE3) you want to edit; FUEL and IGNITION can be easily modified.

Scegliere quale delle due MODALITÀ sulle tre disponibili (MODE2 e MODE3) si vuole editare; i parametri INIEZIONE e ACCENSIONE possono essere facilmente modificati.

Edit single or multiplies breakpoint by tapping on the bottom action bar (EDIT, +, -) or restore factory ECU data by tapping on "FACTORY" button. FUEL range: +30% / -30% - IGNITION range: +4° / -12°

Editare breakpoint singoli o multipli selezionando nella barra in basso (tasti Edit, + e -) o ripristinare i dati di serie della Centralina tappando sul bottone Factory (intervallo iniezione + 30% / - 30%, intervallo accensione +4° / - 12°)

## ADDITIONAL ACCESSORIES

### ACCESSORI AGGIUNTIVI



**GL-0169-AA**  
**Power Supply Cable for GK-WFCOM2-0002**

This cable allows to connect WiFi-COM to a fully charged 12V battery and power it up to map while the engine is off. This needs to avoid engine overheating while mapping.

Il cavo consente di alimentare il WiFi-COM tramite una batteria a 12 V e mappare mentre il motore è spento. Questo serve ad evitare un surriscaldamento del motore mentre si programma.





Photo: Lucio Buselli - Overlook farm

MOTORCYCLES



POWER TOOLS

**POWER TOOLS**

# LITHIUM BATTERIES

## LITHIUM IRON PHOSPHATE POWERSPORT BATTERY

### BATTERIA LITIO FERRO FOSFATO POWERSPORT



#### GK-ATHBL-0003

VOLTAGE	ENERGY	CAPACITY	CCA
12,8V	32Wh	2,5Ah	175A

DIMENSIONS AND WEIGHT  
107 x 85 x 56 mm, 500 g



#### GK-ATHBL-0004

VOLTAGE	ENERGY	CAPACITY	CCA
12,8V	25,6Wh	2Ah	140A

DIMENSIONS AND WEIGHT  
86 x 90 x 48 mm, 420 g

GET Lithium-Ion batteries range features high power in reduced weight and dimensions. They have been developed following the requests of teams, mechanics and riders, including all the applications in only two models. This brings important advantages: compact range of items to manage, easy storage, higher overall performances compared to OE batteries and prompt crank even under extreme conditions.

GET Lithium batteries are manufactured with a unique gluing technology, which provides insulation to the internal components and guarantees extended service life, improved starting ability with cold weather, outside shock absorbing and higher heat conductivity.

These products have been designed starting from Dirt Bikes which currently have an OEM Lithium battery installed, but they are also suitable to replace original lead acid batteries.

Le nuove batterie al litio GET per moto Off-Road offrono elevata potenza in dimensioni e peso ridotti. Sono state sviluppate seguendo le richieste di team, meccanici e piloti e con solo due modelli riescono a essere compatibili con tutte le principali moto offroad. Questi aspetti permettono importanti vantaggi: una gamma compatta di articoli da gestire, una facile conservazione, prestazioni complessive più elevate rispetto alle batterie OE e un pronto avviamento anche in condizioni estreme. Le batterie sono prodotte con una speciale tecnologia di resinatura che protegge le parti interne da freddo e umidità, aumentando la vita del prodotto, la capacità di avviamento a freddo, le proprietà conduttive e l'assorbimento degli urti. Questa nuova gamma GET è stata ideata per moto che nascono con una batteria al litio originale, ma si propone anche per sostituire le batterie al piombo acido compatibili.

## KEY BENEFITS

### PUNTI DI FORZA



**OUTSTANDING COLD CRANK POWER**  
ELEVATE CAPACITÀ DI AVVIAMENTO A FREDDO



**HIGH TEMPERATURE RESISTANT**  
RESISTENTE AD ALTE TEMPERATURE



**SUPER-FAST CHARGING RATE**  
TEMPO DI RICARICA SUPER VELOCE



**WATER RESISTANT IP54 CERTIFIED**  
CERTIFICATO IP54 RESISTENTE ALL'ACQUA



**SUPER LIGHTWEIGHT**  
PESO ESTREMAMENTE RIDOTTO



**ROBUST BRASS TERMINAL**  
ROBUSTI TERMINALI IN OTTONE

## APPLICATION LIST

### LISTA APPLICAZIONI

MAKE	MODEL	CC	FROM	TO	P/N
BETA	RR 2T	250/300	2018	2023	GK-ATHBL-0003
	RR 4T	350/390/430/480	2018	2023	GK-ATHBL-0003
GAS GAS	EC 2T	250 / 300	2021	2023	GK-ATHBL-0003
	EC F	250 / 350	2021	2023	GK-ATHBL-0003
	EX 2T	300	2021	2023	GK-ATHBL-0003
	EX 2T	250	2022	2023	GK-ATHBL-0003
	EX F	250/350/450	2021	2023	GK-ATHBL-0003
	MC F	250 / 450	2021	2023	GK-ATHBL-0003
HONDA	CRF R	250	2018	2021	GK-ATHBL-0004
	CRF R	450	2018	2020	GK-ATHBL-0004
	CRF RX	250	2019	2021	GK-ATHBL-0004
	CRF RX	450	2018	2020	GK-ATHBL-0004
HUSQVARNA	FC	250 / 350 / 450	2016	2023	GK-ATHBL-0004
	FC	250 / 350 / 450	2018	2023	GK-ATHBL-0003
	FE	250 / 350 / 450	2017	2023	GK-ATHBL-0003
	FS	450	2018	2023	GK-ATHBL-0003
	FX	350/450	2017	2023	GK-ATHBL-0003
	TE i	250/300	2018	2023	GK-ATHBL-0003
KAWASAKI	TX i	300	2020	2023	GK-ATHBL-0003
	KX F	250	2021	2023	GK-ATHBL-0003
KTM	KX F	450	2019	2023	GK-ATHBL-0003
	EXC TPI	250 / 300	2018	2023	GK-ATHBL-0003
	EXC	300	2009	2023	GK-ATHBL-0003
	EXC-F	250 / 350 / 450	2017	2023	GK-ATHBL-0003
	SMR	450	2021	2023	GK-ATHBL-0003
	SX-F	250 / 350 / 450	2016	2023	GK-ATHBL-0004
	SX-F	250 / 350 / 450	2018	2023	GK-ATHBL-0003
	XC	125	2021	2023	GK-ATHBL-0003
SHERCO	XC TPI	250/350	2020	2023	GK-ATHBL-0003
	XC-F	250/350/450	2016	2023	GK-ATHBL-0003
	XC-W TPI	150	2020	2023	GK-ATHBL-0003
	XC-W TPI	250	2018	2023	GK-ATHBL-0003
	XC-W TPI	300	2019	2023	GK-ATHBL-0003
	XC-F-W	350/500	2020	2023	GK-ATHBL-0003
YAMAHA	SE-R	250/300	2014	2023	GK-ATHBL-0003
	YZ F	250	2019	2023	GK-ATHBL-0003
	YZ F	450	2018	2022	GK-ATHBL-0003
YAMAHA	YZ FX	250	2020	2023	GK-ATHBL-0003
	YZ FX	450	2019	2023	GK-ATHBL-0003
	WR F	250 / 450	2015	2023	GK-ATHBL-0003

For all applications please visit our web site [athena.eu](http://athena.eu)  
 Visita il sito [athena.eu](http://athena.eu) per la lista applicazioni completa

## MAIN FEATURES

### CARATTERISTICHE PRINCIPALI

#### GK-ATHBL-0003 REPLACEABLE BATTERY TYPE:

LITHIUM	LEAD-ACID
HJTZ5S-FP	YTX4L-BS
HJTZ7S-FP	YTX5L-BS
BR98	YTZ5S-BS
	YTZ7S
	YTX7A-BS

#### GK-ATHBL-0004 REPLACEABLE BATTERY TYPE:

LITHIUM
C22S
HY85S

## TECHNICAL COMPARISON COMPARATIVA TECNICA

GET LITHIUM BATTERIES  
BATTERIE AL LITIO GET

OTHER LITHIUM BATTERIES  
ALTRE BATTERIE AL LITIO

LEAD ACID BATTERIES  
BATTERIE PIOMBO ACIDO

### THERMAL INSULATION

The cell stability is ensured by a perfect thermal insulation: with GET Lithium Batteries, the cranking power is efficient in all weather condition.

### ISOLAMENTO TERMICO

La stabilità delle celle è garantita da un perfetto isolamento termico: la potenza di avviamento delle Batterie GET è ottima in qualsiasi condizione climatica.

### HEAT RESISTANT CASE

Keeping the battery pack safe is a paramount to preserve performance: GET Lithium Battery case is made with a resistant material which avoids explosion and melting.

### INVOLUCRO ESTERNO RESISTENTE AL CALORE

Tenere al sicuro il pacco batterie è essenziale per preservarne le prestazioni: l'involucro delle batterie al litio GET è realizzato in un materiale resistente che elimina il rischio di esplosione o scioglimento.



### COLD CRANK POWER

An higher CCA allows safe, efficient and repeated starts even at low temperatures.

### CAPACITÀ DI AVVIAMENTO A FREDDO

Un CCA più alto assicura avvii sicuri, efficienti e continui anche a basse temperature.



### WEIGHT AND DIMENSIONS

The lighter, the faster: especially when it comes to racing, having a lightweight, yet performing battery definitely makes the difference.

### PESO E DIMENSIONI

Più leggera, più veloce: soprattutto in gara, avere una batteria performante ma leggera può decisamente fare la differenza.

### LONG SHELF LIFE

A reduced self discharge preserves the energy stored in the battery: with GET Lithium batteries it is possible to start the bike even after extended storage.

### LUNGA DURATA

Un livello di autoscarica ridotto preserva l'energia accumulata nella batteria: con le batterie al litio GET la moto si accenderà senza problemi, anche se non utilizzata per molto tempo.

## GLUE FILLING RESINATURA



The innovative gluing technology fine-tuned in GET laboratories provides 4 main benefits:

L'innovativa tecnologia di resinatura, perfezionata nei laboratori GET, assicura 4 vantaggi principali:

- 1 CELL STABILITY**  
 Cell structure is preserved even in cold weather and with high humidity levels.  
**STABILITÀ DELLE CELLE**  
 La struttura delle celle viene preservata anche a temperature molto basse e con alti tassi di umidità.
- 2 HIGH HEAT CONDUCTIVITY**  
 The heat transfers perfectly from and to the cells for the best charge and discharge rate.  
**OTTIMA CONDUTTIVITÀ TERMICA**  
 Il calore si trasferisce perfettamente da e verso le celle per garantire un corretto regime di carica e scarica.
- 3 INSULATION**  
 The gluing has great insulation properties: it improves CCA and keeps the battery warm even in cold weather.  
**ISOLAMENTO**  
 La resina ha ottime proprietà isolanti: migliora la capacità di spunto a freddo (CCA) e protegge le celle anche con temperature molto rigide.
- 4 SHOCK ABSORPTION**  
 Glue filling perfectly absorbs outside shocks even in extreme conditions, ensuring the best performance and durability.  
**ASSORBIMENTO DEGLI URTI**  
 La resinatura assorbe perfettamente gli impatti esterni anche in condizioni estreme, assicurando così migliori performance e massima durata.

**HIGHLY RESISTANT CASE**  
INVOLUCRO ULTRA RESISTENTE



**THE OUTSIDE IS AS IMPORTANT AS THE INSIDE.**

The case developed by GET engineering team features high-quality components which ensure:

**L'ESTERNO È IMPORTANTE QUANTO L'INTERNO.**

Il case ideato dal team di tecnici GET include componenti di alta qualità che garantiscono:

**ENHANCED PERFORMANCE**

The durable brass terminals have been designed to improve electrical conductivity and to support mechanical stresses.

**MIGLIORI PERFORMANCE**

I resistenti terminali in ottone sono stati progettati per migliorare la conduttività elettrica e per resistere agli stress meccanici.

**HIGH TEMPERATURE PROTECTION**

The case material is flame and fire resistant and can stand temperature over 230°C, way higher than competitors' (generally made in ABS).

**RESISTENZA AD ALTE TEMPERATURE**

L'involucro esterno è prodotto con un materiale resistente al calore e al fuoco e può sopportare temperature superiori a 230 °C, molto di più quindi rispetto alle altre batterie presenti sul mercato (generalmente prodotte in ABS).



**BORN FOR RACING**  
NATE PER IL RACING

**GET THE REAL POWER**

GET Batteries have been developed by GET engineers to satisfy the needs of MX racing teams. The batteries have undergone more than 25 different safety and performance tests on specific benches, tracks and inside temperature-controlled chambers.

**GET THE REAL POWER**

Le batterie GET sono state sviluppate dagli ingegneri GET per rispondere alle esigenze dei più importanti team di Motocross. Le batterie sono state sottoposte a oltre 25 test di sicurezza e di performance su banchi specifici, in pista e all'interno di sale prove climatiche.



Photo: Lucio Buselli - Overlook farm

# BATTERY CHARGER

**AUTOMATIC LITHIUM-PB BATTERY CHARGER AND MAINTAINER**  
**CARICABATTERIE E MANTENITORE AUTOMATICO LITIO-PIOMBO**



**INCLUDED IN THE KIT**  
**INCLUSO NEL KIT**



CABLE WITH CLAMPS



EYELET TERMINAL CONNECTORS

Battery Charger is the ultimate portable multi-phase digital electronic charger for both lead-acid and lithium-ion batteries (LifePO4). It performs multiple analysis to monitor battery activity for safe and efficient charging. It features a built-in battery desulfator to rejuvenate underperforming batteries. When accidentally unplugged or loses power, the microprocessor remembers the last charge phase in progress. Battery Charger is also able to attempt the recovery of deeply discharged batteries down to 2V. It is super-safe, spark-proof, protected against polarity reversal and short circuit and is IP65 certified.

Battery Charger è il nuovissimo caricatore elettronico digitale multifase portatile per batterie al piombo e agli ioni di litio (LifePO4). Esegue analisi cicliche per monitorare l'attività della batteria per una ricarica sicura ed efficiente. È dotato di un desolfatore di batteria integrato per ripristinare batterie con prestazioni insufficienti. In caso venga scollegato accidentalmente o perda alimentazione, il microprocessore ricorda l'ultima fase di carica in corso. Battery Charger è anche in grado di tentare il recupero di batterie completamente scariche fino a 2V. È super sicuro, protetto contro le scintille, l'inversione di polarità e il corto circuito ed è certificato IP65.

MODEL	P/N
BATTERY CHARGER	GK-GETBC-0001

## KEY BENEFITS

### PUNTI DI FORZA



**SUPER SAFE**  
 MASSIMA SICUREZZA



**MULTIPLE ANALYSIS**  
 ANALISI CICLICHE



**WATERPROOF IP65**  
 CERTIFICATO IP65  
 RESISTENTE ALL'ACQUA



**ERGONOMIC DESIGN**  
 DESIGN ERGONOMICO

**MAIN FEATURES****CARATTERISTICHE PRINCIPALI**

<b>POWER SUPPLY VOLTAGE</b>	EU version: 220V
<b>FREQUENCY</b>	50-60 Hz
<b>CHARGING CURRENT (min-MAX)</b>	1A
<b>CHARGING AND TESTING STAGES</b>	9
<b>BATTERY VOLTAGE</b>	12V
<b>CHARGE CAPACITY</b>	2Ah-40Ah
<b>MAINTENANCE CAPACITY</b>	2Ah-100Ah
<b>IP PROTECTION</b>	IP65
<b>DIMENSIONS</b>	180x80x40mm
<b>WEIGHT</b>	0,5 Kg





# JUMPSTARTER MINI

MULTIFUNCTIONAL MINI STARTER - MINI AVVIATORE MULTIFUNZIONE



DISCOVER MORE  
SCOPRI DI PIÙ



**INCLUDED IN THE KIT**  
**INCLUSO NEL KIT**



SMART  
CLAMPS



USB 3 IN 1

GET introduces JumpStarter Mini, the second-generation multifunctional Jump Starter. Now lighter and smaller, it is ready to help you to restart any motorcycle or scooter when the battery is low. You can also use the built-in powerful LED flashlight or charge your electronic devices using it as Power Bank. JumpStarter Mini comes together with a hard, water resistant case, perfect for carrying it anywhere and protecting it in every condition.

GET presenta JumpStarter Mini, il nuovo avviatore di emergenza multifunzione di ultima generazione. Più leggero e più compatto, JumpStarter Mini è pronto a riavviare qualsiasi modello di moto o scooter quando la batteria è scarica. Inoltre, è possibile sfruttarlo tutti i giorni, come potente torcia a LED o come pratica Power Bank per ricaricare i dispositivi elettronici in qualsiasi momento. JumpStarter Mini è completo di custodia rigida e resistente all'acqua, perfetta per trasportarlo ovunque e proteggerlo in ogni condizione.

MODEL	P/N
JUMPSTARTER MINI	GK-JMPSTR-0002

## KEY BENEFITS

### PUNTI DI FORZA



**LIGHT & PORTABLE**  
LEGGERO E TASCABILE



**EASY TO USE**  
FACILE DA USARE



**SUPER SAFETY**  
MASSIMA SICUREZZA

**MAIN FEATURES****CARATTERISTICHE PRINCIPALI**

<b>BATTERY - BATTERIA</b>	mAh	6000
<b>SIZES - DIMENSIONI</b>	mm	133 x 66 x 16.49
<b>WEIGHT - PESO</b>	g	176.5
<b>OUTPUT - USCITA</b>	V/A	5V/1A - 5V/2.1A
<b>INPUT - INGRESSO</b>	V/A	5V/1A
<b>STARTING CURRENT - CORRENTE DI AVVIAMENTO</b>	A	200
<b>PEAK CURRENT - CORRENTE DI PICCO</b>	A	360
<b>GAS ENGINE RATING - MAX CILINDRATA SUPPORTATA</b>	cc	2000 benzina



Photo: Lucio Buselli - Overlook farm

# GET MERCH



**HUB USB**  
MULTIPLA PORTA USB



**KEY HOLDER**  
PORTACHIAVI



**STICKERS**  
ADESIVI

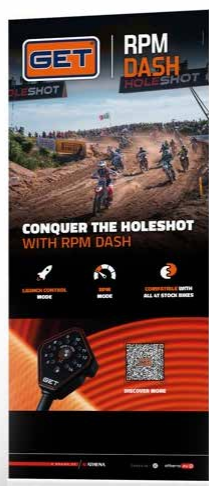

**RPM DASH ROLLUP**  
ROLLUP RPM DASH  
ON REQUEST SU RICHIESTA



**ECU ROLLUP**  
ROLLUP CENTRALINE  
ON REQUEST SU RICHIESTA



**GET FLAG MINI**  
BANDIERA GET MINI  
ON REQUEST SU RICHIESTA



**GET GAZEBO**  
ON REQUEST SU RICHIESTA



**GET T-SHIRT**  
MAGLIETTA GET



**GET POLO**  
POLO GET



**GET/ATHENA SOFT SHELL**  
GIACCA LEGGERA GET/ATHENA



**CAP**  
BERRETTINO



**UMBRELLA**  
OMBRELLA



**POP HOURMETERS**  
ESPOSITORE DA BANCO HOURMETERS



**WINDOW STICKER "GET OFFICIAL DEALER"**  
VETROFANIA "GET OFFICIAL DEALER"

# ATHENA GROUP

## MAIN CONTACTS

### CONTATTI PRINCIPALI

#### BUSINESS UNIT GET

Via delle Albere 13, 36045 Alonte – Vicenza (Italy)

Phone: +39 0444 727272

Fax: +39 0444 727292

Email: [sales.get@athena.eu](mailto:sales.get@athena.eu)

Website: [athena.eu](http://athena.eu)

AthenaMotorsport  

#### ATHENA HEADQUARTERS

Via delle Albere 13, 36045 Alonte – Vicenza (Italy)

Phone: +39 0444 727272

Fax: +39 0444 727222

#### VEDAMOTORS

Estrada Blumenau, 2222 – Bairro Bremer

Rio do Sul – SC – 89.160-000 – Brasil

Phone: +55-47-3411 0500

Fax: +55-47-3411 0501

#### ATHENA MOTOR IBERICA

C/Joiers 17 Nave 7, 08184 Palau Solità i Plegamans

Barcelona - Spagna

Phone: +34 935 744 857

Fax: +34 935 606 912

#### ATHENA USA INC.

2308 58th Ave East Bradenton, FL - 34023 - USA

Phone: 1 855 741 2121

Fax: 1 631 244 0556

## OUR LOCATIONS

### LE NOSTRE SEDI

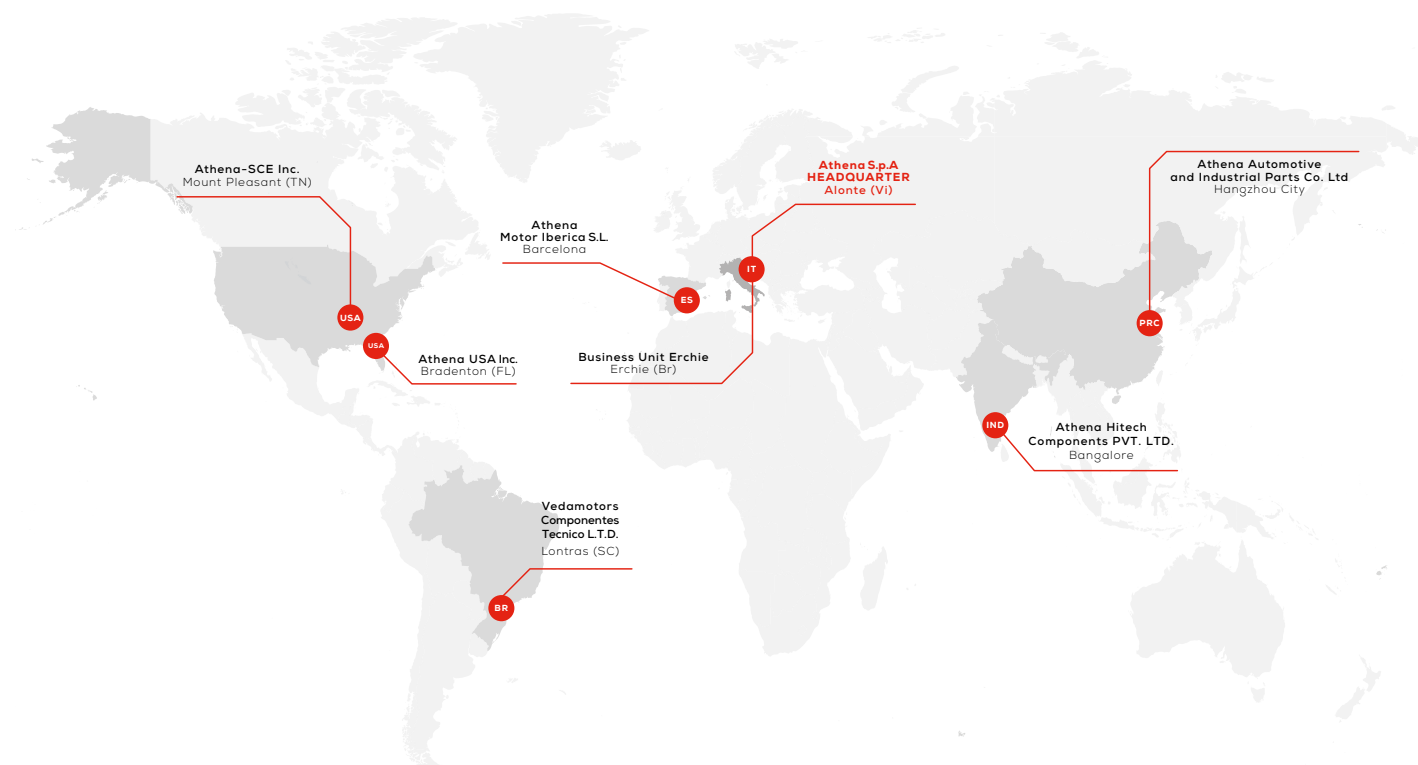





Photo: Lucia Buselli - Overlook farm

**BUSINESS UNIT GET**  
Via delle Albere 12,  
36045 Alonte – Vicenza (Italy)  
Phone: +39 0444 727272  
Fax: +39 0444 727292  
Email: [sales.get@athena.eu](mailto:sales.get@athena.eu)  
Website: [athena.eu](http://athena.eu)  
AthenaMotorsport    
[getdatait](https://www.getdatait.com) 

A BRAND OF /  **ATHENA**