

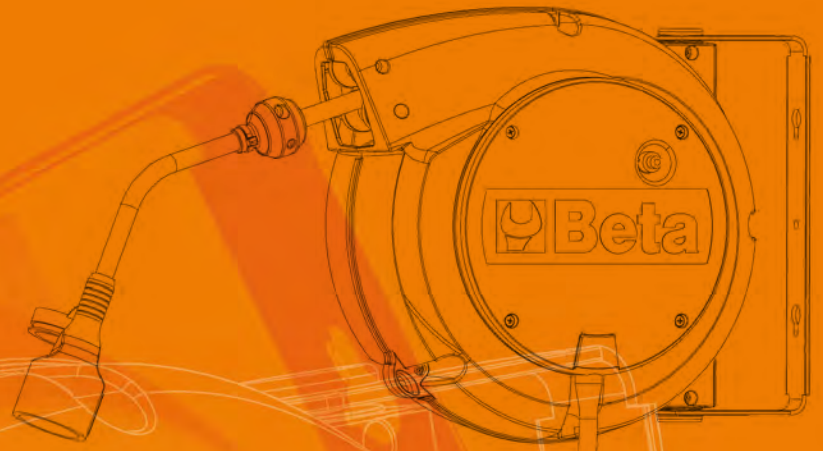

2022

REELS
CATALOGUE



Beta's new range of hose and cable reels have been designed and developed to provide users with the widest choice together with durability, practicality and safety in mind.

- A wide range of cable reels in different cables lengths with standard accessories or the possibility to add your own.
- Hose reels that are suitable for the continuous and frequent movement of air as well as water.



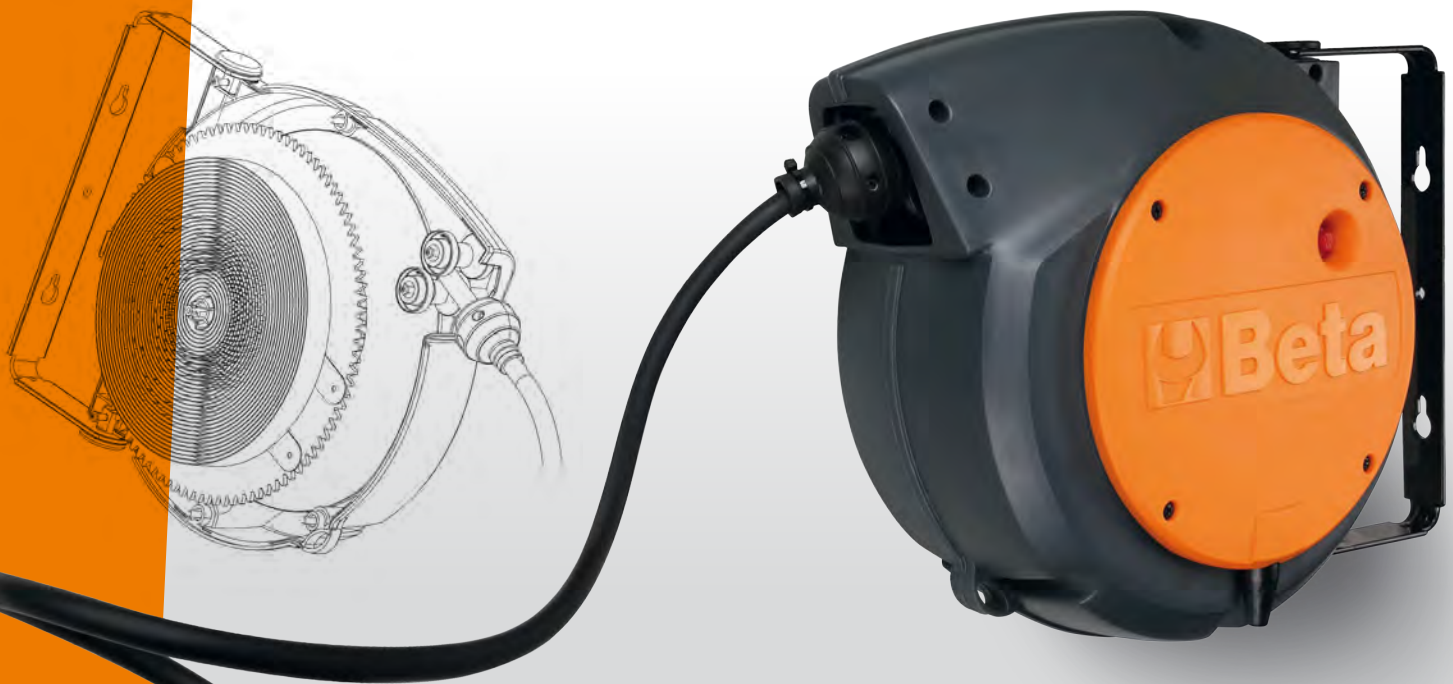

Impact resistance and durability

Drums made of **thick polypropylene** provide a high levels of shock resistance. High-strength springs ensuring remarkable and unparalleled smoothness. **Cables perfectly rewound and protected**, damage and wear are reduced to a minimum.



Practicality of use

Rack device causing automatic cable rewind to stop, that can be disabled to allow continuous pulling. The length of the desired hose can be adjusted according to the application.

In addition, each reel is fitted with a **180° swivel wall-mount bracket** and an **additional bracket for quick connection**, and disconnection from, the wall-mount support.

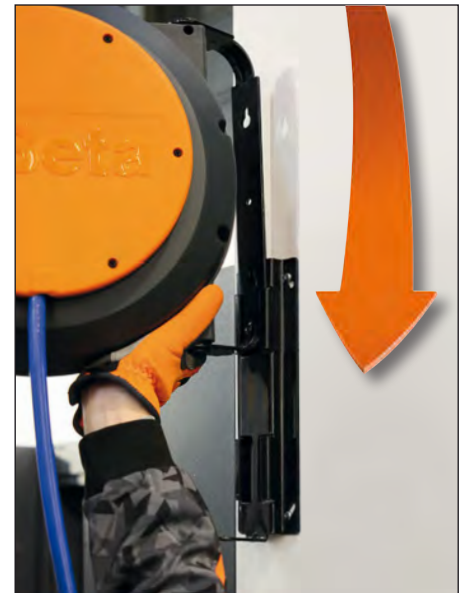













Order and safety in the workplace

A tidy and safe working environment rounds off the list of benefits. The rewinders ensure an **orderly and efficient workplace**. Cables are in place, ready to be used without wasting valuable time. An orderly equipment is also safe. The user can move around without the risk of tripping over or damaging the equipment itself.

Key reading

Electrical cable reels













	Electrical
	Conductors
	Cable length
	Thermal protection
	Coiled/rolled cable power
	Uncoiled/unrolled cable power
	Socket and plug
	LED lamp
	CE standard
	Drum A: Small B: Medium
	Weight
	Code

Air/water hose reels









	Air
	Water
	Hose length
	Hose diameter
	Fittings
	Temperature
	CE standard
	Drum A: Small B: Medium
	Weight
	Code







Cable reels

Item	Conductors	Section	Cable type	Cable length	Page
					
 1842	2x	1,0 mm ²	H05VV-F	15+1,5 m	8
 1843	2x	1,5 mm ²	H05VV-F	15+1 m	9
 1844	3G	1,5 mm ²	H05VV-F H07RN-F	10+1 m 15+1 m 30+2 m 14+1 m	10
 1844SCK	3G	1,5 mm ²	H05VV-F H07RN-F	15+1 m 14+1 m	11
 1845	3G	2,5 mm ²	H05VV-F H07RN-F	12+1 m 15+1 m 25+1,5 m	12
 1846	4G	1,5 mm ²	H05VV-F H07RN-F	10+1 m 15+1 m	13
 1847	4G	2,5 mm ²	H05VV-F H07RN-F	10+1 m 15+1 m	14
 1848	5G	1,5 mm ²	H05VV-F H07RN-F	10+1 m 15+1 m	15

Lighting

Item	Cable length				Page
					
 1840BM	10 m				16
 1842LED/BM	10 m				16
 1842LED/ABM	10 m				16
 1846R-LED/BM	X				16

Hose reels

Item	Ø hose	Hose length			Page
					
 1900S	8 mm	10 m			19
 1900M	8 mm	15 m			20
 1900M	10 mm	15 m			21



CABLE REELS

A wide range comprising no less than 18 versions, designed to satisfy any working requirements, including the most demanding users'.

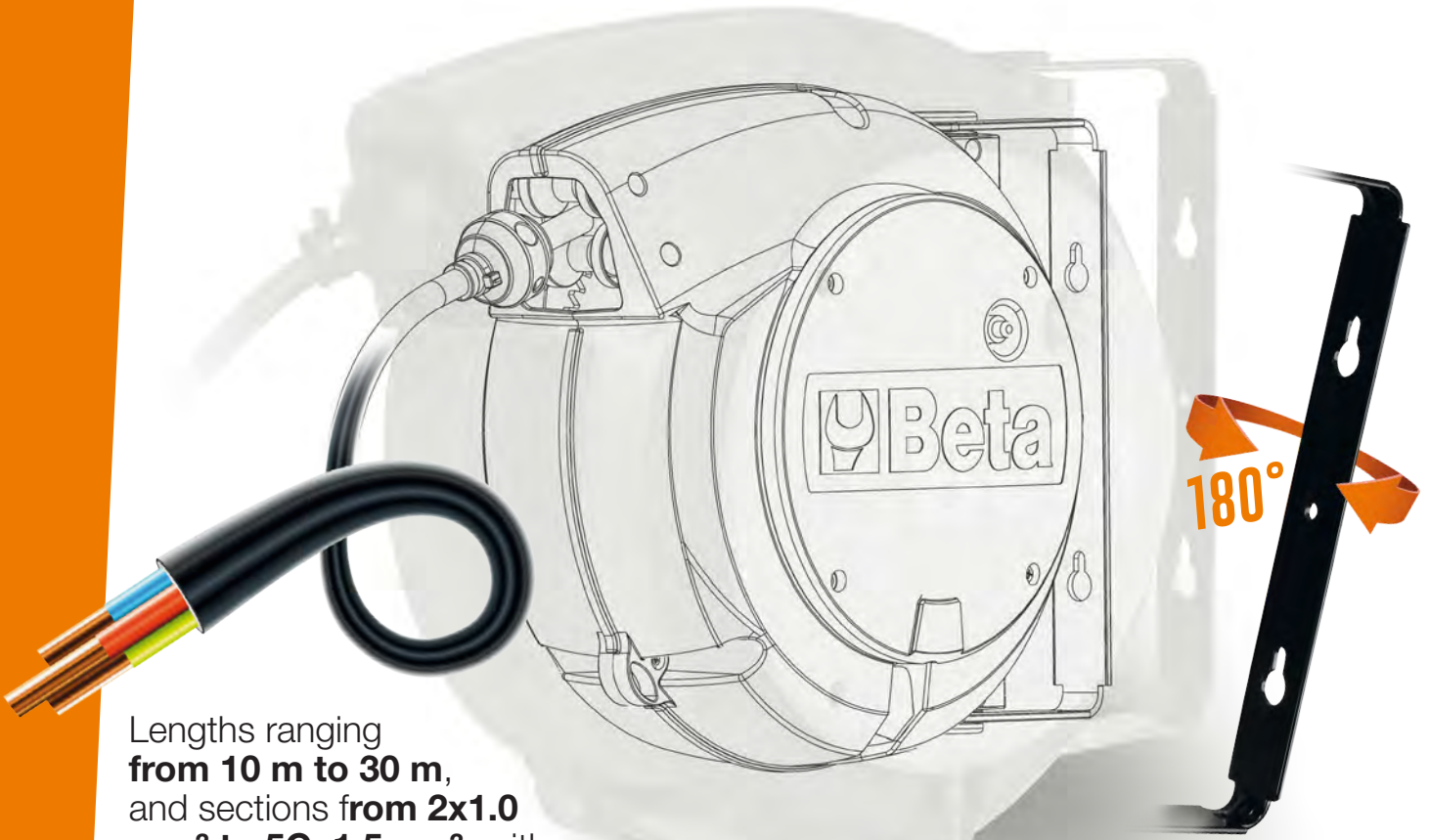

Lengths ranging from 10 m to 30 m, and sections from 2x1.0 mm² to 5Gx1.5mm², with H05VV-F and H07RN-F cable types



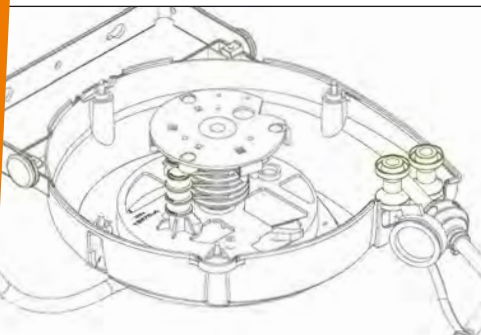

180° swivel wall-mount bracket

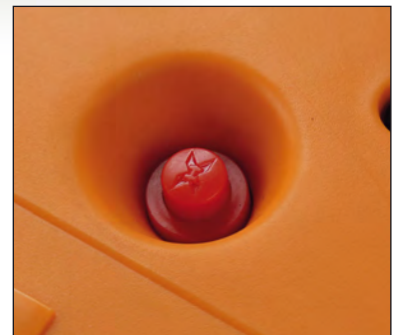

All the cable reels – up to a cable section of 3Gx2.5mm² - are supplied with **thermal protection switches**, which are triggered in case of overloading of the electric circuit.





Item	Code 	Conductors 	Section	Cable type	Cable length 	Drum 	Thermal protection 	Accessory
1842 15-H05/LED	018420821	2x	1,0 mm ²	H05VV-F	15+1 m	A	X	LED lamp
1843 15-H05	018430215	2x	1,5 mm ²	H05VV-F	15+1 m	A	√	X
1844 10-H05	018440310	3G	1,5 mm ²	H05VV-F	10+1 m	A	√	X
1844 15-H05	018440315			H05VV-F	15+1 m	A	√	X
1844 30-H05	018440330			H05VV-F	30+2 m	B	√	X
1844 15-H07	018440317			H07RN-F	14+1 m	A	√	X
1844 15-H05/SCK	018440316	3G	1,5 mm ²	H05VV-F	15+1 m	A	√	SCHUKO
1844 15-H07/SCK	018440318			H07RN-F	14+1 m	A	√	SCHUKO
1845 12-H05	018450365	3G	2,5 mm ²	H05VV-F	12+1 m	A	√	X
1845 15-H07	018450367			H07RN-F	15+1 m	B	√	X
1845 25-H07	018450377			H07RN-F	25+1,5 m	B	√	X
1846 10-H05	018460405	4G	1,5 mm ²	H05VV-F	10+1 m	A	X	X
1846 10-H07	018460407			H07RN-F	10+1 m	A	X	X
1846 15-H05	018460415			H05VV-F	15+1 m	A	X	X
1847 10-H05	018470420	4G	2,5 mm ²	H05VV-F	10+1 m	B	X	X
1847 15-H07	018470427			H07RN-F	15+1 m	B	X	X
1848 10-H05	018480510	5G	1,5 mm ²	H05VV-F	10+1 m	B	X	X
1848 15-H07	018480517			H07RN-F	15+1 m	B	X	X

Automatic cable reel with LED inspection lamp, 100-240Vac

1842



CE IP42
IP65

Features:

- With 230/12V safety transformer
- H05VV-F 2x1.0 mm² cable
- Coiled cable length: 15 m
- 1.5 m incoming cable with SCHUKO type socket
- Length of cable out of drum: 1 m
- Rack mechanism can be disabled to keep cable pulled
- Supplied with a 180° swivel bracket and an additional quick connection bracket

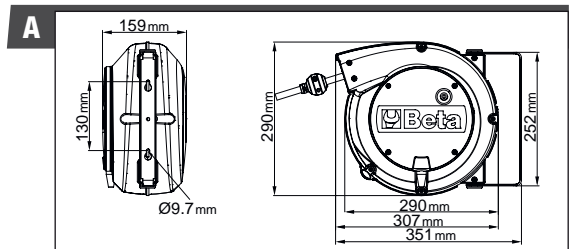

Item	Conductors	Section	Cable type	Cable length	Thermal protection	Accessory	Weight	Code
1842 15-H05/LED	2x	1,0 mm ²	H05VV-F	15+1 m	X	Led Lamp	3,80	018420821

Automatic cable reel,
with 2x1.5 mm² cable

1843



CE IP42

Features:

- H05VV-F 2x1,5 mm² cable
- With thermal protection switch
- Coiled cable length: 15 m
- Cable length out of drum: 1 m
- Supplied without incoming cable
- Rack mechanism can be disabled to keep cable pulled
- Max. power (rolled up): 1300W (230V-20°C)
- Max. power (unrolled): 2300W (230V-20°C)
- Supplied with a 180° swivel bracket and an additional quick connection bracket

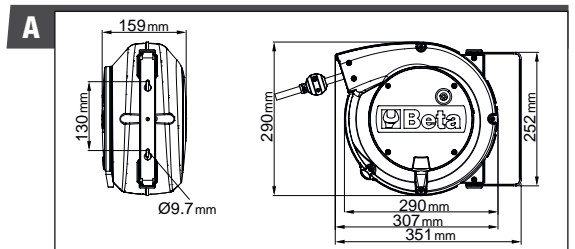

Item	Conductors	Section	Cable type	Cable length	Thermal protection	W 230V-20°C	W 230V-20°C	Weight	Code
1843 15-H05	2x	1,5 mm ²	H05VV-F	15+1 m	✓	1300	2300	4,20	018430215

Automatic cable reel,
with 3Gx1.5 mm² cable

1844



CE IP42

Features:

- 3Gx1.5 mm² cable
- With thermal protection switch
- Cable length out of drum: 1 m (except for 1844 30-H05, 2 m)
- Supplied without incoming cable
- Rack mechanism can be disabled to keep cable pulled
- Max. power (rolled up): 1500W (230V-20°C)
- Max. power (unrolled): 2500W (230V-20°C)
- Supplied with a 180° swivel bracket and an additional quick connection bracket

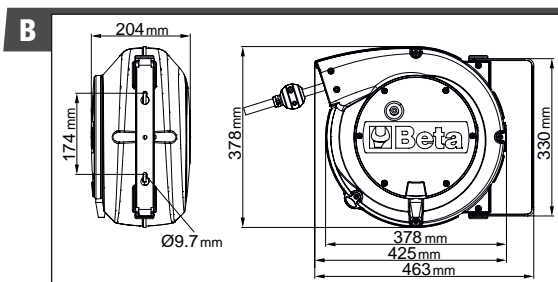
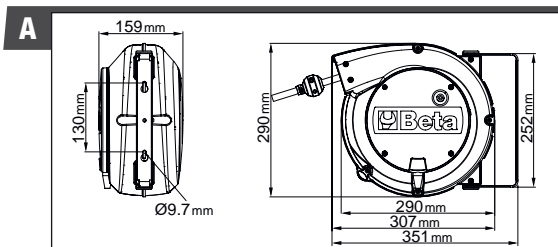

Item	Conductors	Section	Cable type	Cable length	Thermal protection	W 230V-20°C	W 230V-20°C	Drum	Weight	Code
1844 10-H05	3G	1,5 mm ²	H05VV-F	10+1 m	✓	1500	2500	A	3,90	018440310
1844 15-H05	3G	1,5 mm ²	H05VV-F	15+1 m	✓	1500	2500	A	4,60	018440315
1844 30-H05	3G	1,5 mm ²	H05VV-F	30+2 m	✓	1500	2500	B	9,70	018440330
1844 15-H07	3G	1,5 mm ²	H07RN-F	14+1 m	✓	1500	2500	A	5,20	018440317

Automatic cable reel, with 3Gx1.5 mm² cable and SCHUKO type socket

1844SCK



CE IP42

Features:

- 3Gx1.5 mm² cable
- With thermal protection switch
- Length of cable out of drum: 1 m with **SCHUKO** type socket
- Supplied with 1.5 m incoming cable and **SCHUKO** type socket
- Rack mechanism can be disabled to keep cable pulled
- Max. power (rolled up): 1500W (230V-20°C)
- Max. power (unrolled): 2500W (230V-20°C)
- Supplied with a 180° swivel bracket and an additional quick connection bracket

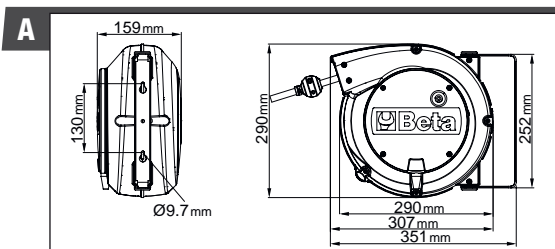

Item	Conductors	Section	Cable type	Cable length	Thermal protection	W 230V-20°C	W 230V-20°C	Socket and plug	Weight	Code
1844 15-H05/SCK	3G	1,5 mm ²	H05VV-F	15+1 m	√	1500	2500	Schuko	5,00	018440316
1844 15-H07/SCK	3G	1,5 mm ²	H07RN-F	14+1 m	√	1500	2500	Schuko	5,70	018440318

Automatic cable reel,
with 3Gx2.5 mm² cable

1845



CE IP42

Features:

- 3Gx2.5 mm² cable
- With thermal protection switch
- Cable length out of drum: 1 m (except for 1845 25-H07RN-F, 1.5 m)
- Supplied without incoming cable
- Rack mechanism can be disabled to keep cable pulled
- Max. power (rolled up): 2000W (230V-20°C)
- Max. power (unrolled): 3000W (230V-20°C)
- Supplied with a 180° swivel bracket and an additional quick connection bracket

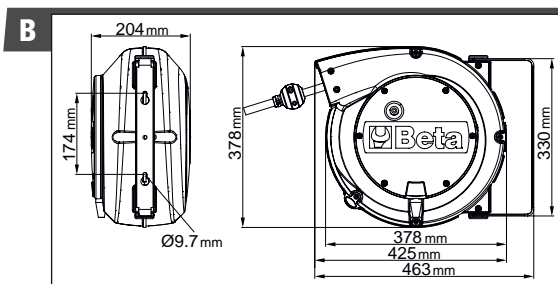
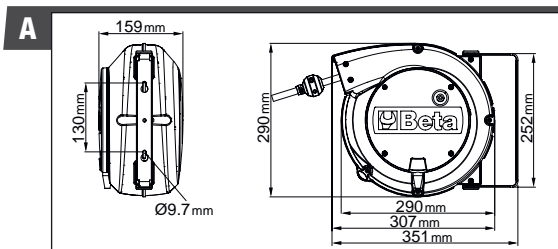

Item	Conductors	Section	Cable type	Cable length	Thermal protection	W 230V-20°C	W 230V-20°C	Drum	Weight	Code
1845 12-H05	3G	2,5 mm ²	H05VV-F	12+1 m	✓	2000	3000	A	4,90	018450365
1845 15-H07	3G	2,5 mm ²	H07RN-F	15+1 m	✓	2000	3000	B	8,30	018450367
1845 25-H07	3G	2,5 mm ²	H07RN-F	25+1,5 m	✓	2000	3000	B	11,00	018450377

Automatic cable reel,
with 4Gx1.5 mm² cable

1846



CE IP42 □

Features:

- 4Gx1.5 mm² cable
- Without thermal protection switch
- Cable length out of drum: 1 m
- Supplied without incoming cable
- Rack mechanism can be disabled to keep cable pulled
- Max. power (rolled up): 1400W (230V-20°C)
- Max. power (unrolled): 1900W (230V-20°C)
- Supplied with a 180° swivel bracket and an additional quick connection bracket

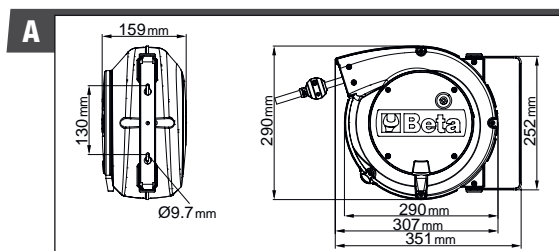

Item	Conductors	Section	Cable type	Cable length	Thermal protection	W 400V-20°C	W 400V-20°C	Weight	Code
1846 10-H05	4G	1,5 mm ²	H05VV-F	10+1 m	X	1400	1900	4,40	018460405
1846 10-H07	4G	1,5 mm ²	H07RN-F	10+1 m	X	1400	1900	5,20	018460407
1846 15-H05	4G	1,5 mm ²	H05VV-F	15+1 m	X	1400	1900	5,40	018460415

Automatic cable reel,
with 4Gx2.5 mm² cable

1847



CE IP42

Features:

- 4Gx2.5 mm² cable
- Without thermal protection switch
- Length of cable out of drum: 1 m
- Supplied without incoming cable
- Rack mechanism can be disabled to keep cable pulled
- Max. power (rolled up): 2000W (230V-20°C)
- Max. power (unrolled): 2700W (230V-20°C)
- Supplied with a 180° swivel bracket and an additional quick connection bracket

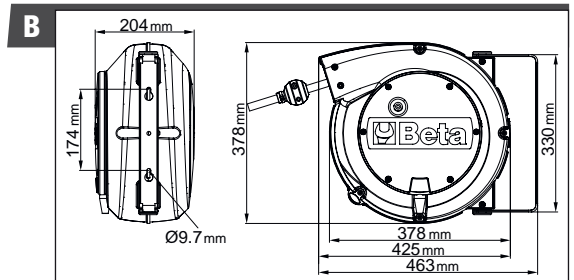

Item	Conductors	Section	Cable type	Cable length	Thermal protection	W 400V-20°C	W 400V-20°C	Weight	Code
1847 10-H05	4G	2,5 mm ²	H05VV-F	10+1 m	X	2000	2700	6,70	018470420
1847 15-H07	4G	2,5 mm ²	H07RN-F	15+1 m	X	2000	2700	8,80	018470427

Automatic cable reel,
with 5Gx1.5 mm² cable

1848



CE IP42

Features:

- 5Gx1.5 mm² cable
- Without thermal protection switch
- Length of cable out of drum: 1 m
- Supplied without incoming cable
- Rack mechanism can be disabled to keep cable pulled
- Max. power (rolled up): 1400W (230V-20°C)
- Max. power (unrolled): 1900W (230V-20°C)
- Supplied with a 180° swivel bracket and an additional quick connection bracket

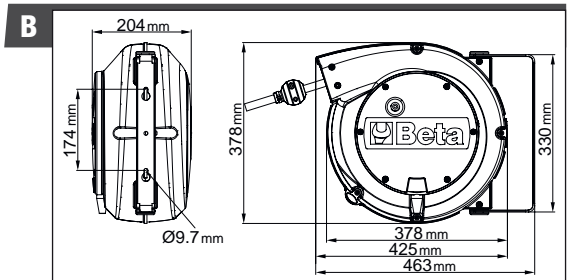

Item	Conductors	Section	Cable type	Cable length	Thermal protection	W 400V-20°C	W 400V-20°C	Weight	Code
1848 10-H05	5G	1,5 mm ²	H05VV-F	10+1 m	X	1400	1900	6,40	018480510
1848 15-H07	5G	1,5 mm ²	H07RN-F	15+1 m	X	1400	1900	8,60	018480517

230V inspection lamp,
base type: E27

1840BM

CE IP20

Features:

- 10-m-long cable
- 230V
- Bulb not included



Item	Cable length	Code
1840BM	10 m	018400101

Lamp with ultra-high
brightness LEDs, 100-240 Vac

1842LED/BM

CE IP65

Features:

- 10-m-long cable
- Compact body made of antislip rubber
- Easy-to-replace front glass
- Swinging hook
- 340 lumens
- With multi-directional head LED light



Item	Cable length	Code
1842LED/BM	10 m	018420301

Lamp with ultra-high
brightness LEDs, 12-24V AC/DC

1842LED/ABM

CE IP65

Features:

- 10-m-long cable
- Compact body made of antislip rubber
- Easy-to-replace front glass
- Swinging hook
- 340 lumens
- With multi-directional head LED light



Item	Cable length	Code
1842LED/ABM	10 m	018420311

Spare LED lamps,
12-24V AC/DC

1846R-LED/BM

CE IP65

Features:

- 12-24V AC/DC
- Compact body made of antislip rubber
- Easy-to-replace front glass
- Swinging hook
- 340 lumens
- With multi-directional head LED light



Item	Code
1846R-LED/BM	018460331





HOSE REELS

A selected range, with lengths ranging from 10 m to 15 m, 8 mm and 10 mm in diameter, for use with pneumatic tools.

Since our products are leak-proof, they can also be used with water.



Braided polyurethane hose

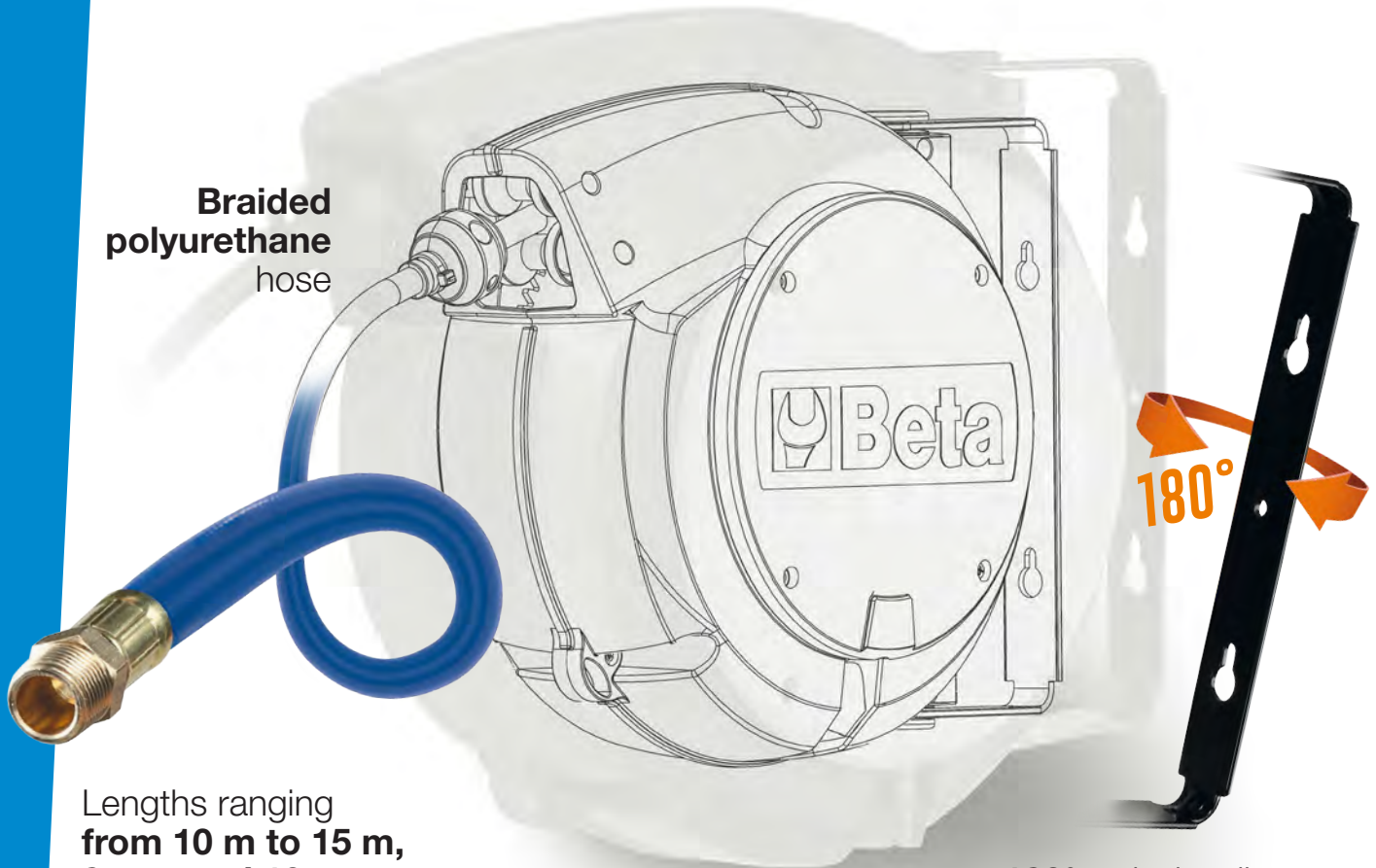

Lengths ranging from 10 m to 15 m, 8 mm and 10 mm in diameter

180° swivel wall-mount bracket

Item	Code	Ø hose	Hose length	Drum	Fittings	Air	Water
1900S 8x10	019000080	8 mm	10 m	A	1/4"	✓	✓
1900M 8x15	019000085	8 mm	15 m	B	1/4"	✓	✓
1900M 10x15	019000115	10 mm	15 m	B	3/8"	✓	✓

Automatic spring hose reel,
with 8x10 mm hose

1900S



CE

Features:

- Automatic hose reel, shockproof plastic body, **for air or water**
- Max. operating pressure: 15 bar
- Braided polyurethane hose
- Polypropylene frame
- Device for automatically fixing hose at required length
- Rack mechanism can be disabled to keep hose pulled
- Water operating temperature range: -5 °C / +50 °C
- Supplied with a 180° swivel bracket and an additional quick connection bracket

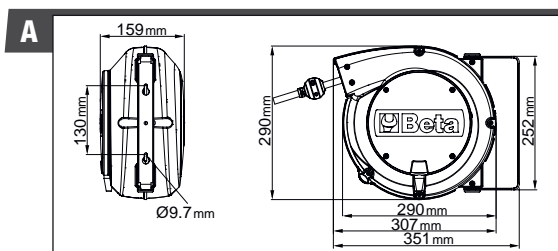

Item	Ø hose D1xD	Hose length	Fitting	Fitting	Max. operating pressure	Max. temperature	Air	Water	Weight	Code
1900S 8x10	8x10 mm	10 m	1/4"	1/4"	15 bar	50°C	√	√	3,90	019000080

Automatic spring hose reel,
with 8x15 mm hose

1900M 8x15



CE

Features:

- Automatic hose reel, shockproof plastic body, **for air or water**
- Max. operating pressure: 15 bar
- Braided polyurethane hose
- Polypropylene frame
- Device for automatically fixing hose at required length
- Rack mechanism can be disabled to keep hose pulled
- Water operating temperature range: -5 °C / +50 °C
- Supplied with a 180° swivel bracket and an additional quick connection bracket

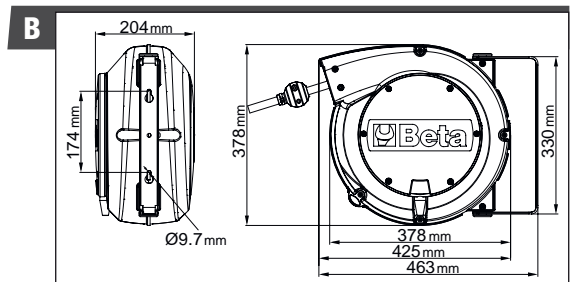

Item	Ø hose D1xD	Hose length	Fitting	Fitting	Max. operating pressure	Max. temperature	Air	Water	Weight	Code
1900M 8X15	8x15 mm	15 m	1/4"	1/4"	15 bar	50°C	✓	✓	6,00	019000085

Automatic spring hose reel,
with 10x15 mm hose

1900M^{10x15}



CE

Features:

- Automatic hose reel, shockproof plastic body, **for air or water**
- Max. operating pressure: 15 bar
- Braided polyurethane hose
- Polypropylene frame
- Device for automatically fixing hose at required length
- Rack mechanism can be disabled to keep hose pulled
- Water operating temperature range: -5 °C / +50 °C
- Supplied with a 180° swivel bracket and an additional quick connection bracket

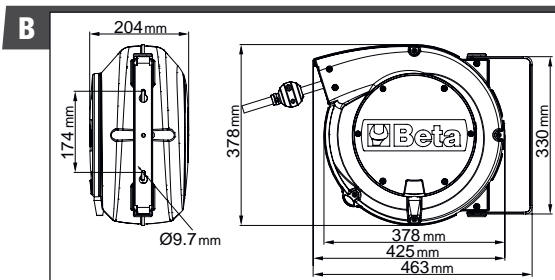

Item	Ø hose D1xD	Hose length	Fitting	Fitting	Max. operating pressure	Max. temperature	Air	Water	Weight	Code
1900M 10X15	10x15 mm	15 m	3/8"	3/8"	15 bar	50°C	√	√	6,80	019000115



ORDER AND SAFETY IN THE WORKPLACE!





099804542

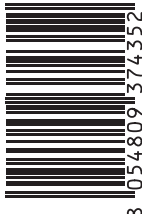

Beta
www.beta-tools.com

Beta Utensili S.p.A.
Via Volta, 18 - 20845 Sovico (MB)
ph. +39 039 20771
www.beta-tools.com

The images are for reference only. Beta Utensili S.p.A. reserves the right to update and upgrade its product range without notice.