

Beta

RSC55



MODULAR SYSTEM



50 Years in Motorsports



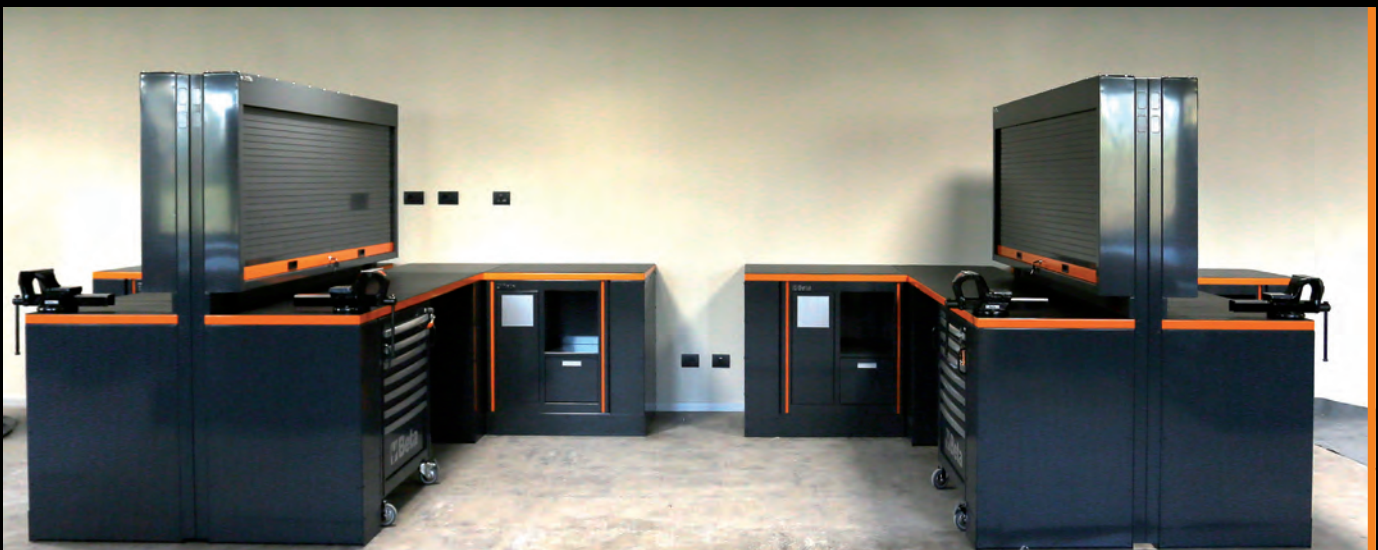



WORKSHOP EQUIPMENT C55

The modular workshop combination that allows you to create a modern work environment customized to fit your space and storage needs. Choose from a wide range of solutions sharing high quality standards, designed to make the most of your time by optimizing work.



SPACE ORGANIZATION

A rationally organized workbench system as synonymous with optimized work

DESIGN

Refined finish to make your workplace a neat, aesthetically captivating environment

MADE IN ITALY



QUALITY

Beta's best
"Made in Italy"
quality to furnish
your workshop

MODULARITY

Modular workshop
system, customized
to fit your space
and storage needs

C55 055000000

Comprehensive workshop equipment combination

Comprehensive combination comprising:

- Single-door tool cabinet (C55A1)
- Two-door tool cabinet (C55A2)
- Workbench (C55B0/2)
- Workbench with sockets (C55PRO B0/2)
- Mobile roller cab with 7 drawers (C55C7)
- Fixed module with 2 storage drawers (C55M2)
- Fixed module with 7 drawers (C55M7)
- Fixed service module (C55MS)
- Tool panel with suspended cabinets (C55/2PM)
- Tool panel with shutter (C55PS-0)



Cabinets fitted with 3 interior, vertically adjustable shelves



Suspended cabinets fitted with gas springs making it easier to open/close doors



Compressed air outlet with built-in roller Ø 8 mm.
Hose length: 10 m



Aluminium drawer front complete with quick release system throughout length of drawer



Aluminium shutter with lock for protecting tools

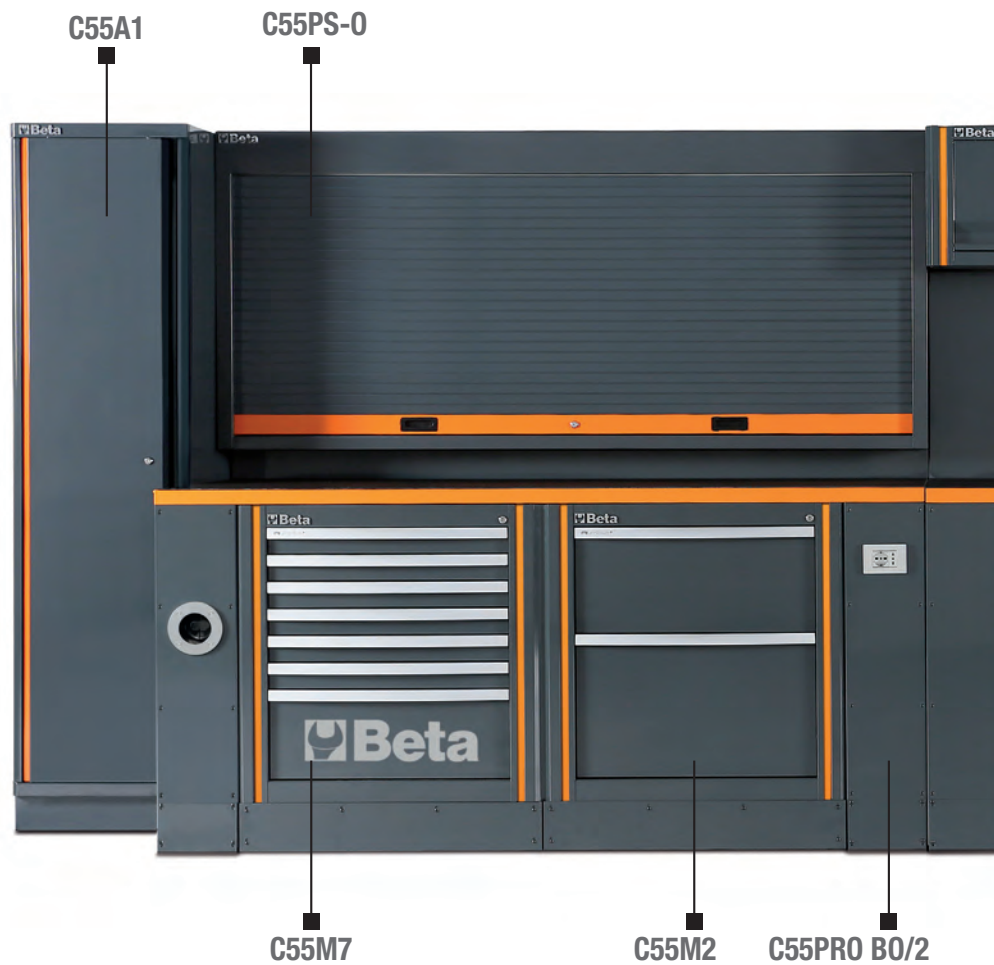

COMBINATION

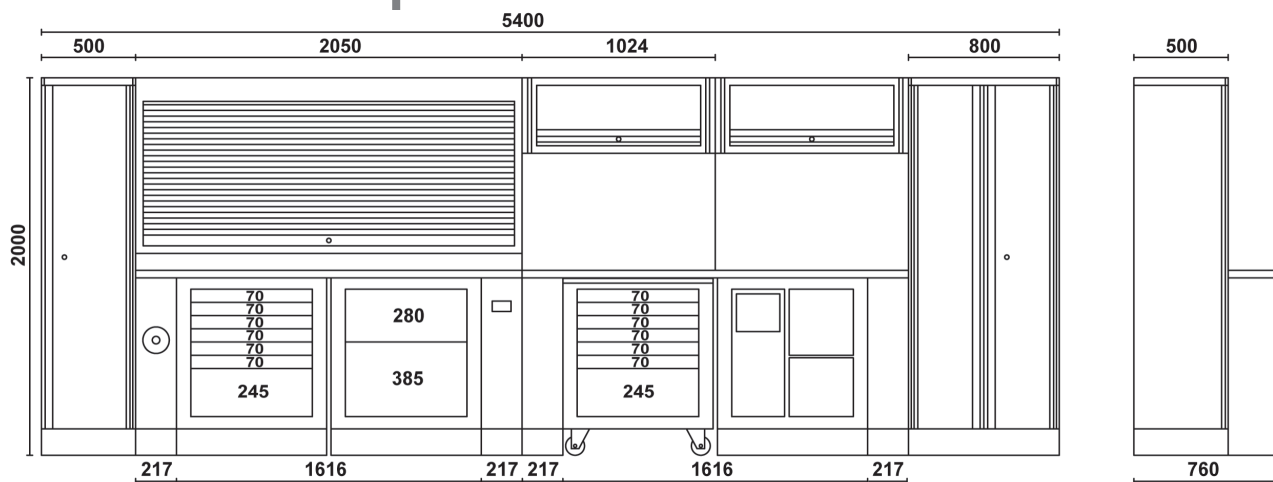

Framework



Schuko socket
16+10A
and EU Plug 10A



Drawers can accommodate
thermoformed tool trays
available in price list



Mobile roller cab with 2 fixed
and 2 steering wheels,
making it easy to pull it out



Adjustable supporting feet
suitable for uneven surfaces

WORKSHOP EQUIPMENT COMBINATION



C55AB

055000020

Workshop equipment combination

Combination comprising:

- Two-door tool cabinet (C55A2)
- Workbench (C55B0/2)
- Fixed module with 7 drawers (C55M7)
- Fixed service module (C55MS)
- Tool panel with suspended cabinets (C55/2PM)

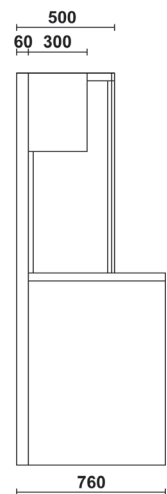
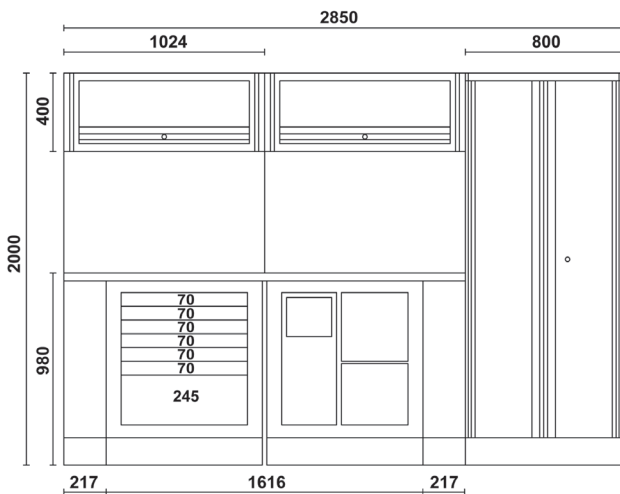

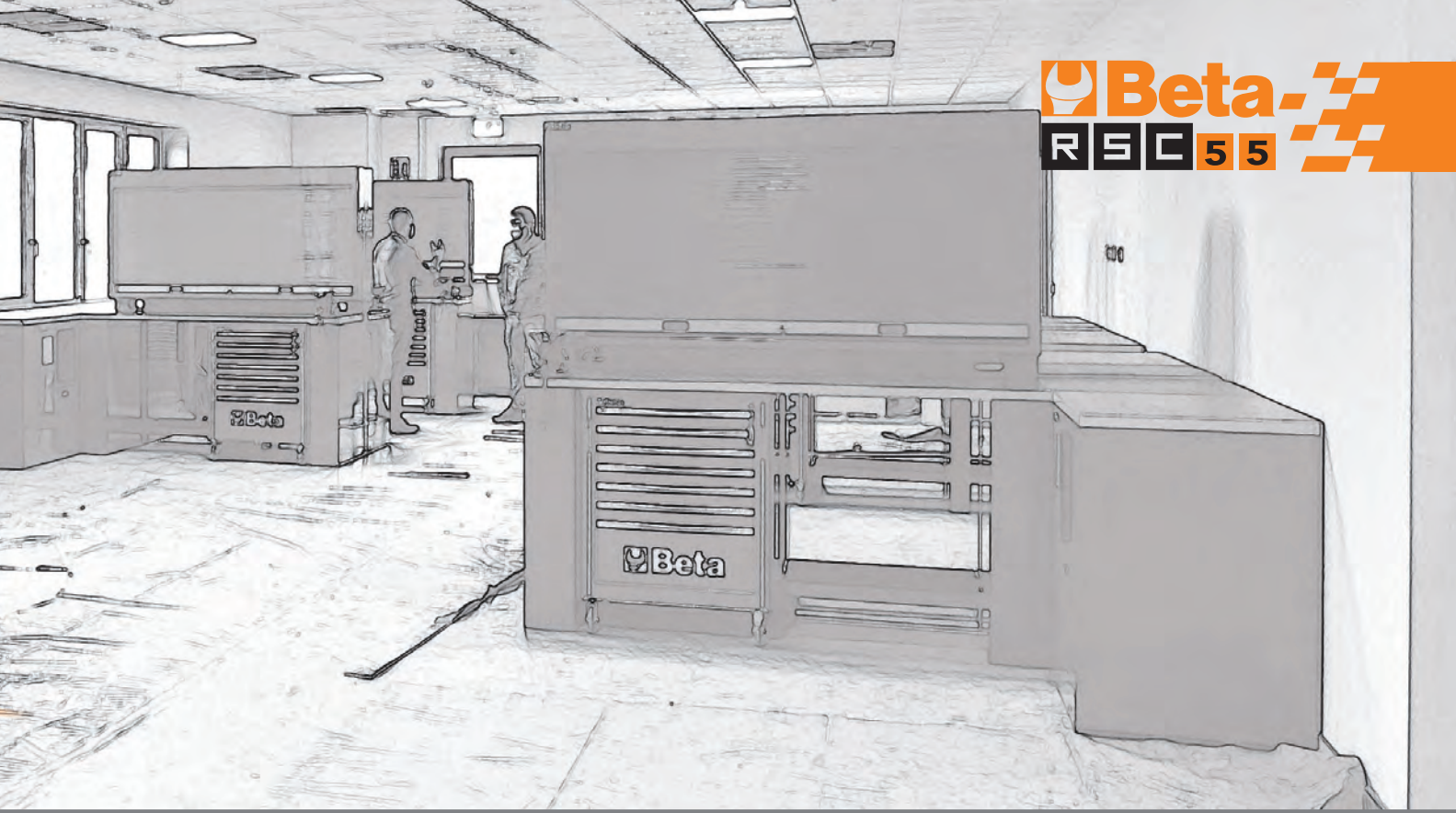

C55PB/3 055000035

Workshop equipment combination

Combination comprising:

- Workbench (C55B0/2)
- Mobile roller cab module with 8 drawers (C55C8)
- Fixed module with 2 storage drawers (C55M2)
- Wall tool system with shutter (C55PS-0)

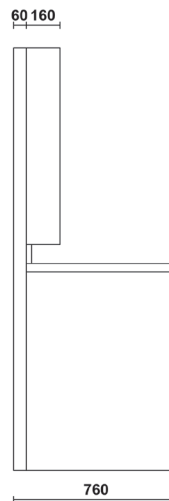
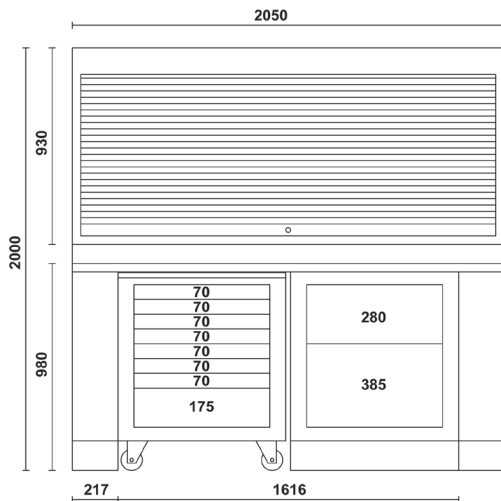
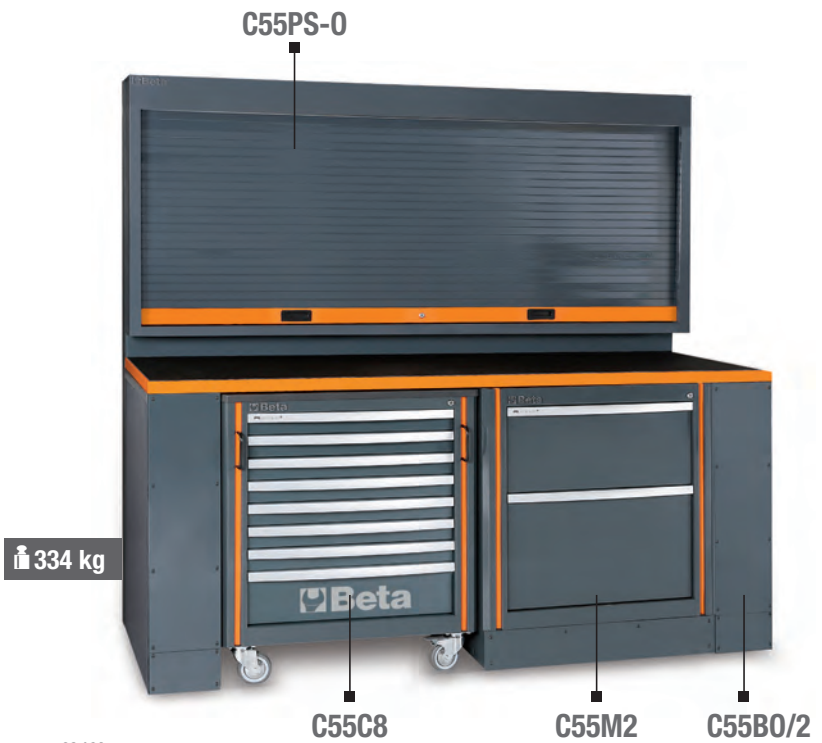

C55PB-PRO/7

055000065

Workshop equipment combination

Composed of:

- Workbench with worktop (C55B0/2)
- Fixed module with seven drawers (C55M7)
- Fixed service module (C55MS)
- Tool wall system (C55/2PM)
- 2 suspended cabinets (C55/PF)

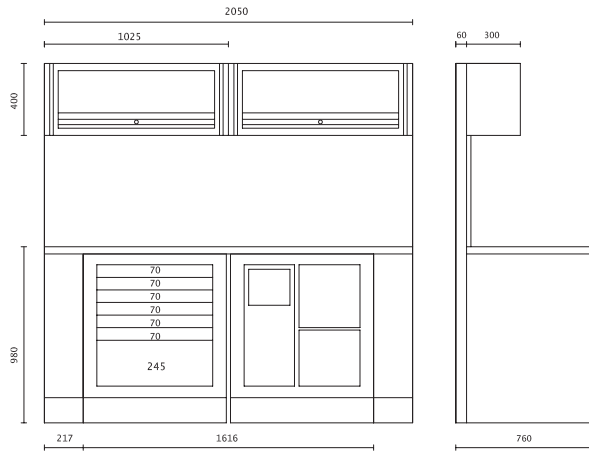

C55PB-PRO/8

055000066

Workshop equipment combination

Composed of:

- Workbench with worktop (C55B0/2)
- Mobile roller cab with seven drawers (C55C7)
- Tool wall system with shutter and framework (C55PS-0)
- Fixed two-door module (C55MA)

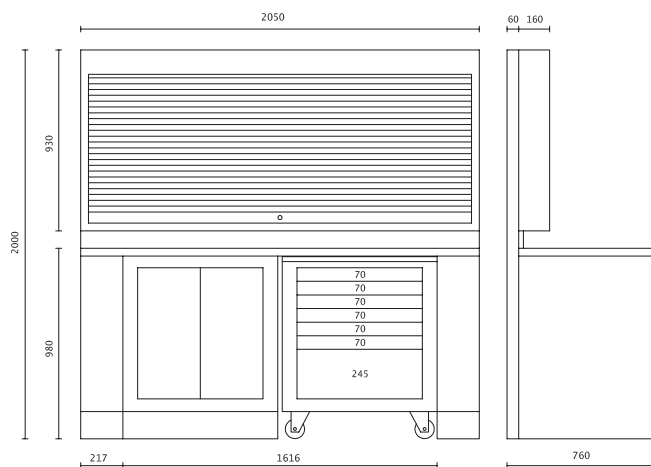

WORKBENCH

Choosing the workbench means the first step in any workshop furniture project.

We at Beta offer pre-arranged solutions in versions 2, 2.8 and 4 metres in length (pages 14÷15), in grey and orange colours. However, you can configure the workbench according to your requirements, choosing the worktop (page 17) and the legs (page 16), which can be used for both sides, are fitted with vertically adjustable feet and are available in single and double versions, with power sockets and hose or cable reels.

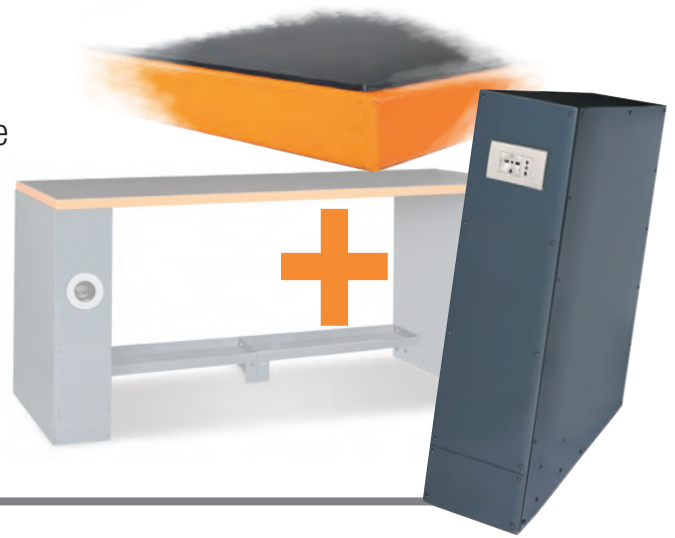

The modules under the workbenches are the heart of the project: mobile or fixed, with drawers or service equipment (pages 18÷21).

The modular system also provides several different solutions for the upper part: plain, suspended or shuttered panels, which can accommodate power sockets (pages 20÷24, 26).

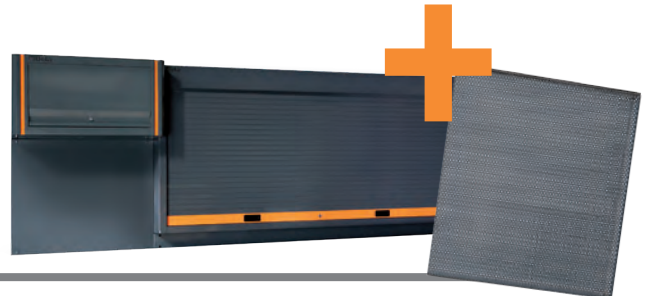

Furthermore, a wide range of accessories allows you to complete the project, adapting it to your requirements (pages 30÷31).



The modular project can be extended and changed in time, as requirements and available spaces vary.



**WORKBENCH
2 m**



**WORKBENCH
2,8 m**



**WORKBENCH
4 m**







- Vertically adjustable feet

C55B/2

2-m-long workbench

Worktop (2050x700 mm) covered with a shockproof, non-scratch PVC coat, resistant to hydrocarbons

- Holes for a vice (1599F/150, to be ordered separately)
- Can accommodate 2 modules under worktop
- Vertically adjustable feet



C55B0/2

055000101



C55BG/2

055000111

Two versions differ in worktop colour

WORKBENCH

800 kg



105 kg

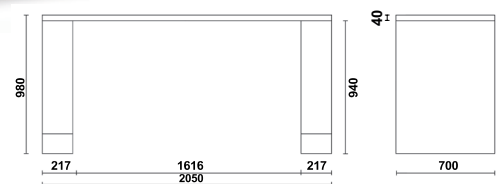

C55B/2,8

2.8-m-long workbench

Worktop (2850x700 mm) covered with a shockproof, non-scratch PVC coat, resistant to hydrocarbons

- Holes for a vice (1599F/150, to be ordered separately)
- Can accommodate 3 modules under worktop
- Vertically adjustable feet



C55B0/2,8

055000261



C55BG/2,8

055000281

Two versions differ in worktop colour

600 kg



129 kg

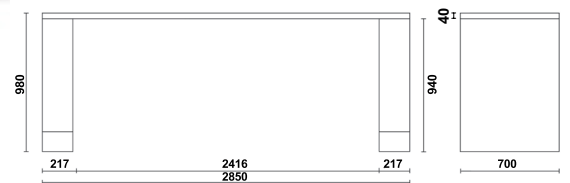

C55B/D4

Double 4-m-long workbench with central leg

Worktop (4100x700 mm) covered with a shockproof, non-scratch PVC coat, resistant to hydrocarbons

- Holes for a vice 1599F/150 (to be ordered separately)
- Vertically adjustable feet
- Double central leg with compartment and slide-away door, 350x750 mm



C55B0/D4

055000109



C55BG/D4

055000119

Two versions differ in worktop colour

1600 kg



185 kg

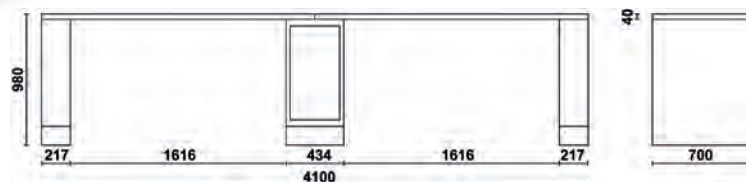



**WORKTOP (2050X700 MM) COVERED WITH A SHOCKPROOF, NON-SCRATCH PVC COAT, RESISTANT TO HYDROCARBONS
BUILT-IN SOCKETS AND ROLLER:**

- Schuko socket+16+10A
- EU Plug 10A
- Compressed air outlet and roller, Ø 8 mm. Hose length: 10 m
- Holes for a vice (1599F/150, to be ordered separately)
- Can accommodate 2 modules under worktop
- Vertically adjustable feet

C55PRO B/2
2-m-long workbench

- Can accommodate 2 modules under worktop



Two versions differ in worktop colour

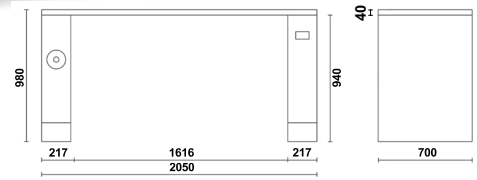

C55PRO B/2,8
2.8-m-long workbench

- Can accommodate 3 modules under worktop



Two versions differ in worktop colour

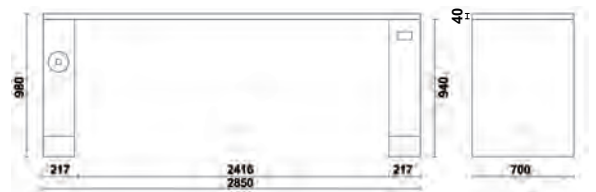
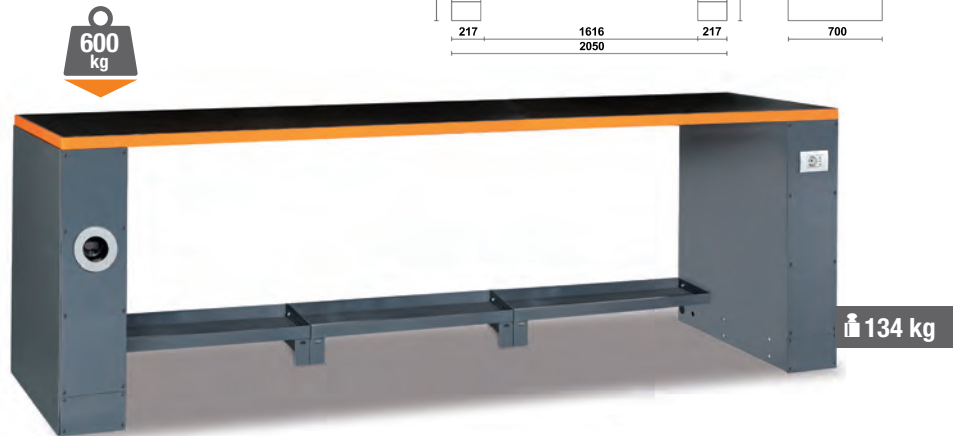

C55PRO B/D4
Double 4-m-long workbench with central leg

- Central double leg with slide-away door compartment, 365x750 mm



Two versions differ in worktop colour

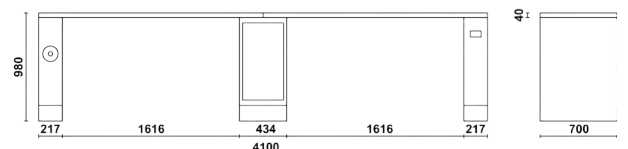

LEGS FOR WORKBENCH

C55B/G 055000096

Universal leg for workbench

- With vertically adjustable feet
- Can be used for both workbench sides
- Front and side opening

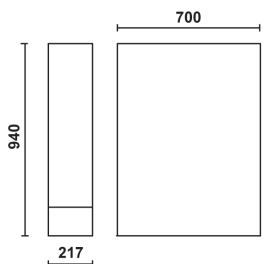

 30 kg



C55B/GAA 055000099

Universal leg for workbench with built-in hose reel

- Built-in automatic hose reel for compressed air or cold water (Ø 8 mm) item 1901BM/8
- Hose length: 10 m
- With vertically adjustable feet
- Front and side opening

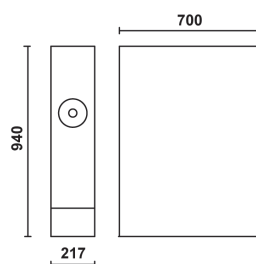

 35 kg



C55B/GDS 055000291

Double leg for adjoining workbenches

- Compartment with slide-away door, 365x750 mm
- With vertically adjustable feet

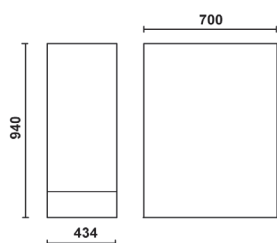

 45 kg



C55B/GDP 055000292

Double leg for adjoining workbenches

- Paper roll holder compartment
- Compartment with door
- With vertically adjustable feet

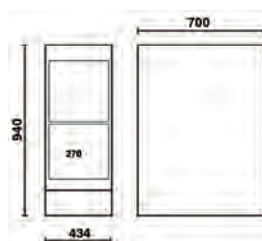

 45 kg



C55B/GE 055000097

Universal leg with power sockets for workbench

- Schuko socket+16+10A
- EU Plug 10A
- With vertically adjustable feet
- Front and side opening

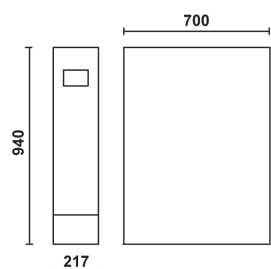

 30 kg



C55B/GAE 055000094

Universal leg with built-in electrical cable reel for workbench

- Built-in automatic cable reel with Schuko type socket item 1848.
- Cable length: 15 m
- Thermally protected
- With vertically adjustable feet
- Front and side opening

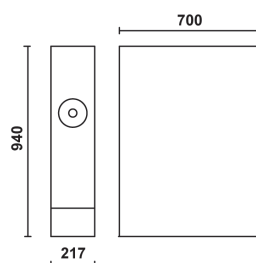

 35 kg



WORKTOPS

C55/PL-1,024

C55/PL0-1,024 055000130
C55/PLG-1,024 055000131

Two versions differ in worktop colour

1-m-long worktop for extension of workbench

Painted sheet metal worktop (1024x700 mm) covered with a shockproof, non-scratch PVC coat, resistant to hydrocarbons

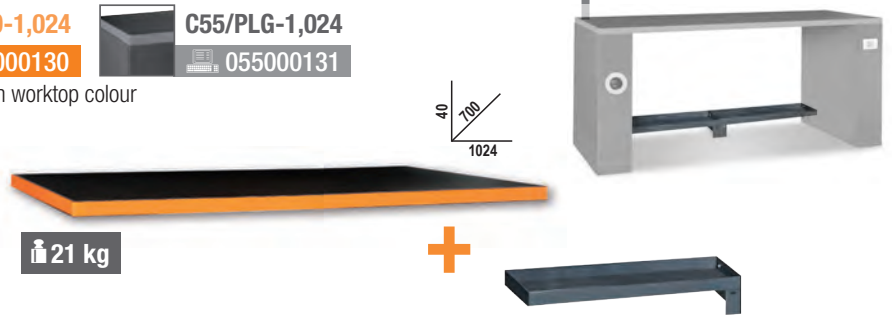

21 kg

C55B PT/2

C55B0 PT/2 055000106
C55BG PT/2 055000116

Two versions differ in worktop colour

2-m-long worktop, for workbench

Painted sheet metal worktop (2050x700 mm) covered with a shockproof, non-scratch PVC coat, resistant to hydrocarbons

Holes for a vice (1599F/150, to be ordered separately)



43 kg

C55B PT/2,8

C55B0 PT/2,8 055000266
C55BG PT/2,8 055000286

Two versions differ in worktop colour

2.8-m-long worktop, for workbench

Painted sheet metal worktop (2850x700 mm) covered with a shockproof, non-scratch PVC coat, resistant to hydrocarbons

Holes for a vice (1599F/150, to be ordered separately)



61 kg

C55RB

Scratch-proof PVC coat resistant to hydrocarbons

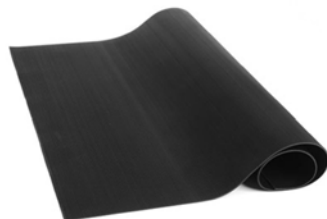

for 700x700mm long workbench

055000199

for 1-m-long workbench

055000198

for 2-m-long workbench

055000195

for 2.8-m-long workbench

055000196

C55B/VS

055000095

Lower workbench bracket for workshop workbenches

Dimensions 800x230x60 mm



4 kg

1599F/150

015990150

Parallel bench vice with hardened top and slides

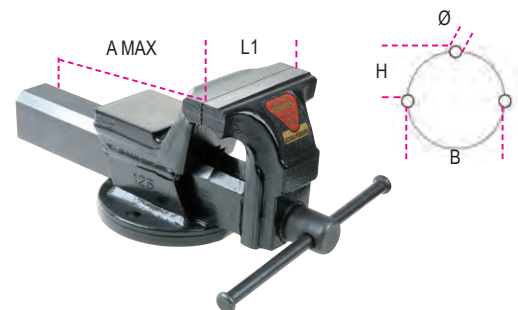

L1	BxH	Ø	A Max
150 mm	125x62 mm	13 mm	200 mm

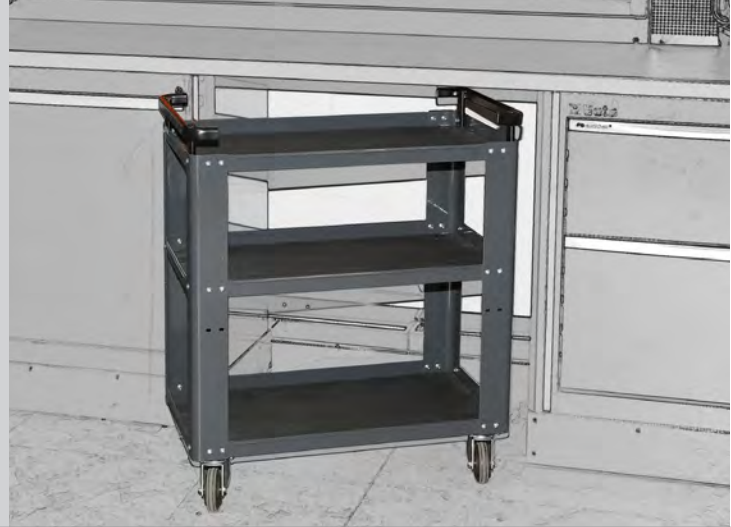

WORKBENCH MODULES

C55T3 055000219

Trolley

- 3 tops covered in antislip ribbed rubber
- Ergonomic handle
- Two fixing options for central worktop
- Four castors Ø 100 mm: 2 fixed and 2 steering with brake
- Static load capacity: 200 kg (distributed between 3 shelves)

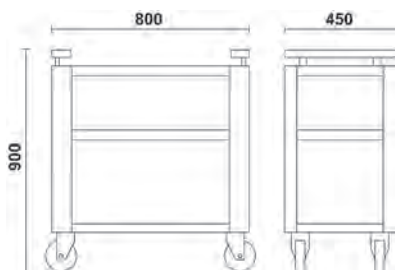

C55C7 055000201

Mobile roller cab with 7 drawers

- 7 drawers (588x367 mm), with ball bearing slides
- 4 castors Ø 100 mm, 2 fixed (one with brake) and 2 steering
- Aluminium opening system throughout length of drawer
- Drawer bases protected by foamed rubber mats
- Front centralized lock
- Can be fitted with foam trays

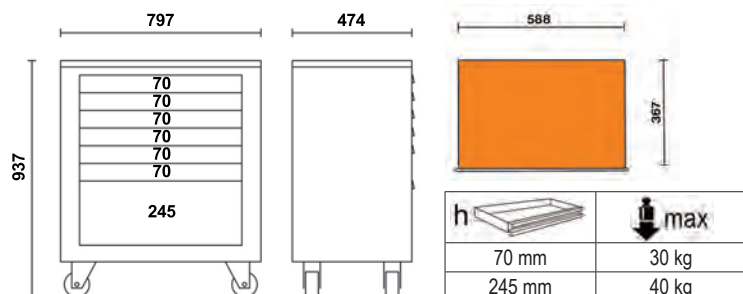

C55C8 055000206

Mobile roller cab with 8 drawers

8 drawers (588x367 mm) with ball bearing slides

- 4 castors Ø 100 mm, 2 fixed (one with brake) and 2 steering
- Aluminium opening system throughout length of drawer
- Drawer bases protected by foamed rubber mats
- Front centralized lock
- Can be fitted with foam trays

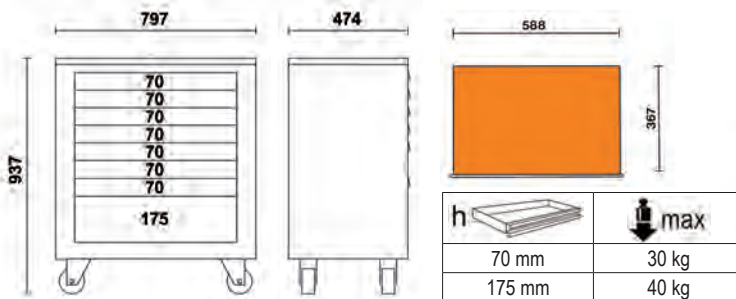

C55M4 055000212

Fixed module with 4 drawers

4 drawers (588x367 mm) with ball bearing slides

- Aluminium opening system throughout length of drawer
- Drawer bases protected by foamed rubber mats
- Front centralized lock

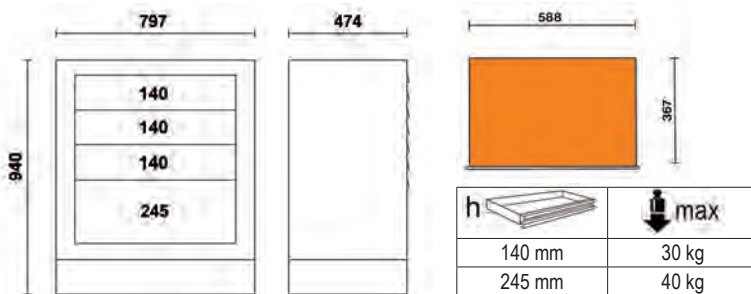

C55M7 055000203

Fixed module with 7 drawers

7 drawers (588x367 mm) with ball bearing slides

- Aluminium opening system throughout length of drawer
- Drawer bases protected by foamed rubber mats
- Front centralized lock
- Can be fitted with foam trays

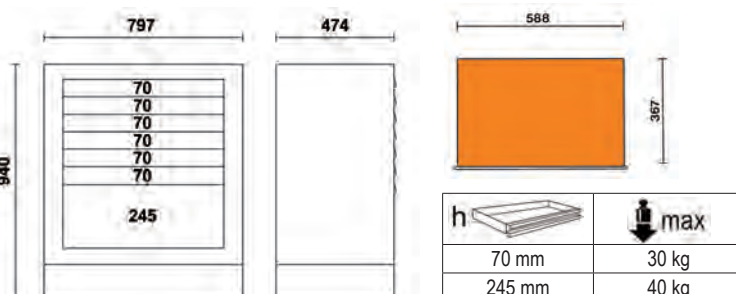

C55M8 055000207

Fixed module with 8 drawers

8 drawers (588x367 mm) with ball bearing slides

- Aluminium opening system throughout length of drawer
- Drawer bases protected by foamed rubber mats
- Front centralized lock
- Can be fitted with foam trays

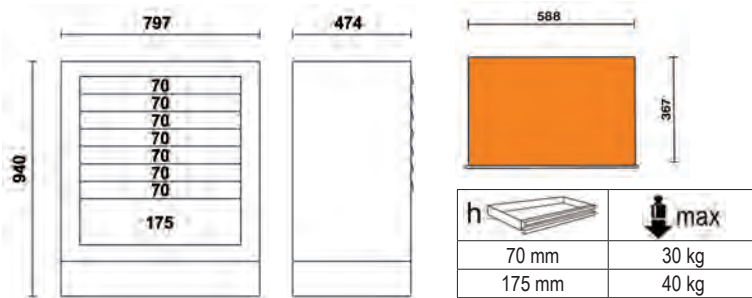

C55M2 055000202

Fixed module with 2 drawers

2 drawers (588x367mm) with ball bearing slides

- Aluminium opening system throughout length of drawer
- Drawer bases protected by foamed rubber mats
- Front centralized lock

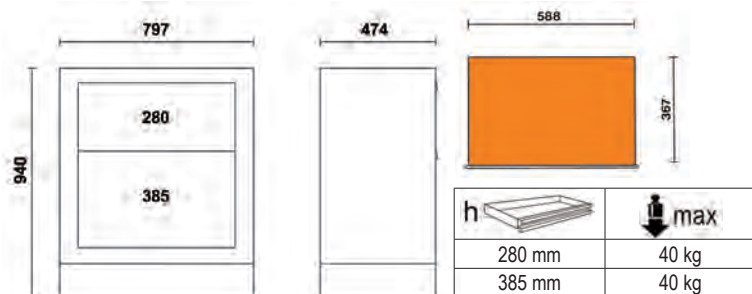

C55MS 055000204

Fixed service module

- Built-in waste bin
- Perforated paper roll compartment
- Storage drawer, 305x270 mm



C55CS 055000208

Fixed module for separate waste

- Pull-out waste compartment (588x465 mm) with ball bearing slides
- 2 capacious pull-out interior containers for sorting waste



C55MA 055000205

Fixed two-door module

- Push Pull opening
- With lock
- Interior shelf, vertically adjustable

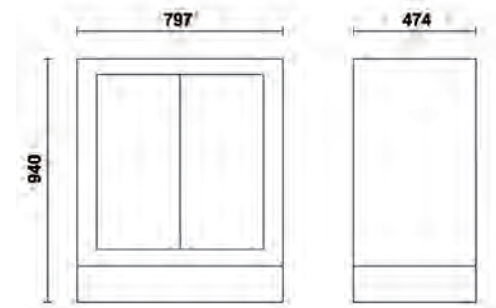

C55MDO 055000210

Fixed oil distribution module

- 2 reels with 7m - 1/2" hose included
- Complete with 2 oil guns with digital litre counter with automatic drip catcher.
 - max. delivery rate: 0÷35 l/min
 - viscosity: 8÷5000 mPas

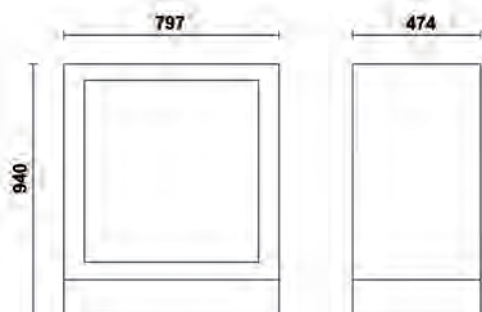

WALL SYSTEMS

1m



C55PFA-1,0

C55PFA-1,0

055000316

Self-supporting perforated panel, 1-m-long

Perforated steel tool panel (1024x1020x25 mm)



C55PM

C55PM

055000302

Suspended cabinet, 1-m-long

Dimensions: 1024x400x300 mm; fitted with gas springs, making it easier to open and close door

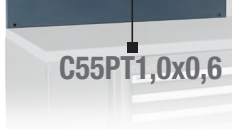

C55PT1,0x0,6

C55PT1,0x0,6

055000314

Under-cabinet panel, 1-m-long

Dimensions: 1024x620x25 mm



C55PM

C55PM

055000302

Suspended cabinet, 1-m-long

Dimensions: 1024x400x300 mm; fitted with gas springs, making it easier to open and close door

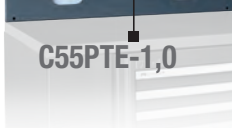

C55PTE-1,0

C55PTE-1,0

055000319

Under-cabinet panel, 1-m-long

Dimensions: 1024x620x25 mm
Accommodates 2 power sockets (not included)



C55PM

C55PM

055000302

Suspended cabinet, 1-m-long

Dimensions: 1024x400x300 mm; fitted with gas springs, making it easier to open and close door

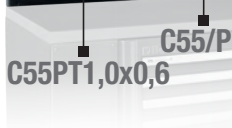

C55PT1,0x0,6

C55PT1,0x0,6

055000314

Under-cabinet panel, 1-m-long

Dimensions: 1024x620x25 mm

C55/PF

055000307

Perforated under-cabinet panel, 1-m-long

Perforated tool panel (1024x620 mm) designed to match C55PT1,0x0,6



C55P/MCD

055000257

Double central intermediate uprights



2000



WALL SYSTEMS

2 m

C55/2PM 055000301

Tool wall system with 2 suspended cabinets

- 2 suspended cabinets, 1024x400x300 mm, fitted with gas springs, making it easier to open and close doors
- 2 wall panels, 1024x620 mm; can accommodate perforated tool panels C55/PF (to be ordered separately)
- Supplied with framework
- Matches 2-m-long workbench



 80 kg

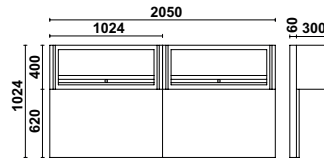

C55PFA-1,0

 055000316

Self-supporting perforated panel, 1-m-long

Perforated steel tool panel (1024x1020x25 mm)

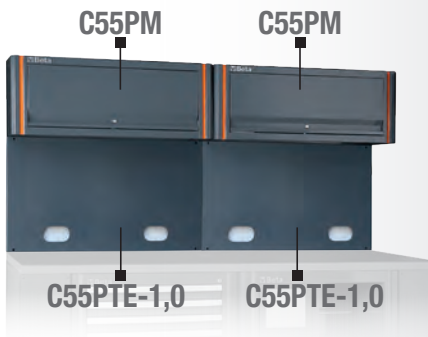

C55PM

 055000302

Suspended cabinet, 1-m-long

Dimensions: 1024x400x300 mm; fitted with gas springs, making it easier to open and close door

C55PTE-1,0

 055000319

Under-cabinet panel, 1-m-long

Dimensions: 1024x620x25 mm
Accommodates 2 power sockets (not included)



C55PM

 055000302

Suspended cabinet, 1-m-long

Dimensions: 1024x400x300 mm; fitted with gas springs, making it easier to open and close door

C55PT1,0x0,6

 055000314

Under-cabinet panel, 1-m-long

Dimensions: 1024x620x25 mm

C55/PF

 055000307

Perforated under-cabinet panel, 1-m-long

Perforated tool panel (1024x620 mm) designed to match C55PT1,0x0,6

C55P/2MDX-SX

 055000253

Right/left wall uprights, pair



C55P/MCD

 055000257

Double central intermediate uprights





WALL SYSTEMS 2 m



C55PS



C55PS-0

055000250



C55PS-G

055000255

Light grey shutter



Tool wall system with shutter

- Aluminium shutter, vertically adjustable, with lock
- Removable perforated tool panel
- Supplied with framework
- 50-hook GPS kit included
- Matches 2-m-long workbench

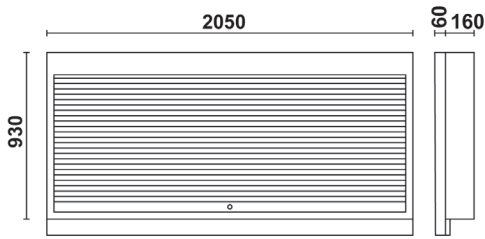

88 kg

C55PSE



C55PSE-0

055000258



C55PSE-G

055000260

Light grey shutter



Tool wall system with shutter accommodating 2 power sockets

- Aluminium shutter, vertically adjustable, with lock
- Removable perforated tool panel
- Supplied with framework
- 50-hook GPS kit included
- Accommodates power sockets (not included)
- Matches 2-m-long workbench

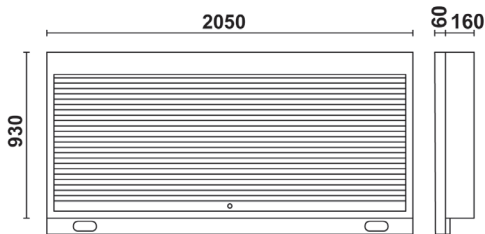

88 kg

C55AE

055000325

Profile, 2 m long, accommodating power sockets

Dimensions 2050x25x90 mm



1,5 kg



WALL SYSTEMS ASSORTMENTS

5958U

059581008

Assortment of 85 tools for universal use hooks included



Quantity/Description

Quantity/Description	Beta N.
17 combination wrenches 6÷22 mm	42
12 offset hexagon key wrenches \varnothing 2÷10 mm	96N/SC12
13 1/2" square drive hexagon sockets with rail \varnothing 10÷22 mm	920A/SB13
8 1/2" square drive hexagon sockets with rail \varnothing 23÷32 mm	920A/SB8
1 1/2" drive extension bar 125 mm	920/21
1 1/2" drive extension bar 255 mm	920/22
1 1/2" drive universal joint	920/25
1 1/2" drive sliding T-handle	920/42
1 1/2" drive reversible ratchet \odot	920/55
1 circlip pliers straight, internal \varnothing 180 mm	1032
1 circlip pliers straight, external \bullet 175 mm	1036
1 slip joint pliers boxed joints 250 mm	1048
1 self - locking pliers 240 mm	1052
1 heavy-duty diagonal cutting nippers \nless 160 mm	1084BM
1 electrician's scissors, straight blades	1128BMX
1 half-round needle nose pliers \equiv 180 mm	1150BM
1 extra-long needle nose pliers \bullet 160 mm	1166BM
7 screwdrivers for cross head screws \bullet 3x75 - 3,5x100 - 4x125 - 5,5x150 - 6,5x150 - 8x200 - 10x200 mm	1260
4 screwdrivers for cross head Phillips® screws \oplus PH0x60 - PH1x80 - PH2x100 - PH3x150 mm	1262/S4
1 engineer's hammer 300 g	1370
1 soft face hammer \varnothing 35 mm	1390
1 measuring tape 5 m	1692
5 set of 5 second-cut files, with handles 200 mm	1719BMA/S5
1 hacksaw frame, aluminium handle	1725
1 plastic oil can 150 cc	1754
1 snap - off blade utility knife	1771

5957U-P

059571004

Assortment of 133 tools for universal use hooks included



Quantity/Description

Quantity/Description	Beta N.
6 pin punches 2 ÷ 8 mm	31/SP6
6 2 drift punches, 1 centre punch, 3 flat chisels with metal holder	38/SP6
17 combination wrenches 6÷22 - 24 - 27 - 30 - 32 mm	42/S17X
12 double open end wrenches 6x7 ÷ 30x32 mm	55/S12X
8 offset hexagon key wrenches 2 ÷ 10 mm	96T/S8
8 offset key wrenches, for Torx® head screws \odot T9 ÷ T40	97TX/SC8
1 adjustable wrench 250 mm	111
13 1/2" square drive hexagon sockets with rail \varnothing 10 ÷ 22 mm	920A/SB13
8 1/2" square drive hexagon sockets with rail \varnothing 23 ÷ 32 mm	920A/SB8
7 socket drivers for cross head Phillips® screws \bullet \oplus 1,2x65 - 1,2x8 - 1,6x9 - 2x12mm - PH1-PH2-PH3	920LH/SB7
1 circlip pliers straight, internal \varnothing 180 mm	1032
1 circlip pliers bent, internal \varnothing 170 mm	1034
1 circlip pliers straight, external \bullet 175 mm	1036
1 circlip pliers bent, external \bullet 175 mm	1038
1 slip joint pliers boxed joints 250 mm	1048
1 self - locking pliers 240 mm	1052
1 tin snips 250 mm	1112
1 electrician's scissors, straight blades	1128BMX
8 set of screwdrivers 2,5x50 - 3x75 - 4x100 - 5,5x125 - 6,5x150 - PH0 - PH1 - PH2	1263/D8
2 engineer's hammer 300 - 600 g	1370
1 soft face hammer 35	1390
1 measuring tape 5 m	1692/5
1 flexible magnetic pick-up tool	1712E/2
1 two cutting edges scraper 200 mm	1717A
1 three - cutting edges scraper 200 mm	1717B
5 second cut files 200 mm	1719BMA8/S5
1 metal oil can 200 cc	1751
1 snap - off blade utility knife	1771BM
1 1/2" drive extension bar 125 mm	920/21
1 1/2" drive extension bar 250 mm	920/22
1 1/2" drive universal joint	920/25
1 1/2" drive sliding T-handle	920/42
1 1/2" drive reversible ratchet \odot	920/55
1 pry bar	963
1 Diagonal cutting nippers \nless 160 mm	1082BM
1 Heavy-duty diagonal cutting nippers \nless 160 mm	1084BM
1 toggle lever assisted end cutting nippers \nless 180 mm	1092V
1 half-round needle nose pliers \equiv 180 mm	1150BM
1 Extra-long needle nose pliers \bullet 160 mm	1166BM
1 Extra-long bent needle nose pliers \bullet 160 mm	1168BM
2 screwdrivers for cross head screws \bullet 8x200 - 10x200 mm	1260
1 screwdrivers for cross head Phillips® screws \oplus PH3 8x150mm	1262
1 sliding gauge	1650
1 hacksaw frame, aluminium handle 420 mm	1725

SOLUTIONS



WALL SYSTEMS
2m +
0,80m



C55PFA-0,8

055000315

Self-supporting perforated panel, 0.8-m-long

Perforated steel tool panel (800x1020x25 mm)



C55P/MCD

055000257

Double central intermediate uprights



C55PM/M0,8

055000312

Suspended cabinet, 0.8-m-long

Dimensions: 800x400x300 mm; fitted with gas springs making it easier to open and close door



C55PTE-0,8

055000318

Under-cabinet panel, 0.8-m-long

Dimensions: 800x620x25 mm
Accommodates 1 power socket (not included)



C55PM/M0,8

055000312

Suspended cabinet, 0.8-m-long

Dimensions: 800x400x300 mm; fitted with gas springs making it easier to open and close door



C55PT0,8X0,6

055000313

Under-cabinet panel, 0.8-m-long

Dimensions: 800x620x25 mm

C55/1PF

055000309

Perforated under-cabinet panel, 0.8-m-long

Perforated tool panel (800x620 mm)

C55AC

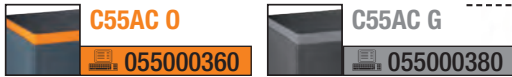

Two versions differ in worktop colour

Self-supporting complete corner

- Worktop (700x700 mm) with legs
- 2 upper tool wall systems complete with 2 fixing shelves (670x160 mm)

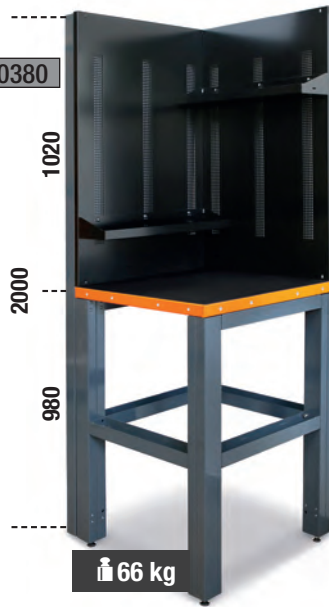

CORNERS



C55KAS 055000370

Upper corner with tool wall systems

- 2 perforated tool wall systems (700x1020x25 mm)
- 2 fixing shelves (670x160 mm)



C55KAI



Two versions differ in worktop colour

Corner worktop, 700x700 mm combination with legs

Painted sheet metal worktop (700x700 mm) covered with a shockproof, non-scratch PVC coat, resistant to hydrocarbons



C55MP 055000374

Steel shelves for corner elements



C55B/1 055000090 055000091

Two versions differ in worktop colour

Extension workbench, 1-m-long Worktop (1024x700 mm) covered with a shockproof, non-scratch PVC coat, resistant to hydrocarbons

- Universal leg with vertically adjustable feet
- 1 fixed module: 7 drawers (588x367 mm) with ball bearing slides

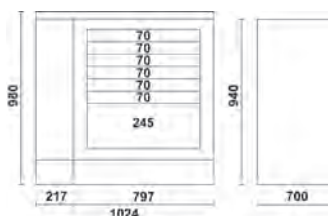

h	max
70 mm	30 kg
245 mm	40 kg

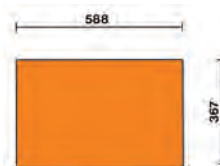

CABINETS

C55AT1

055000421

Sheet metal tool cabinet with clear polycarbonate door

- 3 removable, vertically adjustable shelves
- With lock
- Usable interior dimensions: 1770x420x420 mm

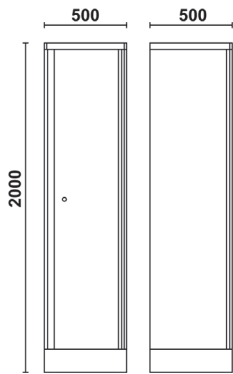

41 kg



C55AT2

055000422

Sheet metal tool cabinet with clear polycarbonate door

- 3 removable, vertically adjustable shelves
- With lock
- Usable interior dimensions: 1770x700x420 mm

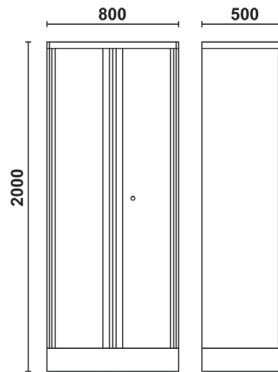

56 kg



C55A1

055000411

Sheet metal single-door tool cabinet

- 3 removable, vertically adjustable shelves
- With lock
- Usable interior dimensions: 1770x420x420 mm

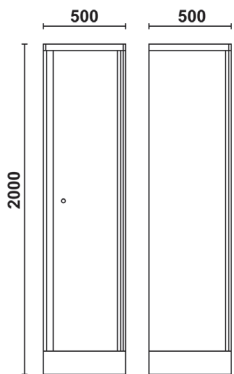

50 kg



C55A2

055000412

Sheet metal two-door tool cabinet

- 3 removable, vertically adjustable shelves
- With lock
- Usable interior dimensions: 1770x700x420 mm

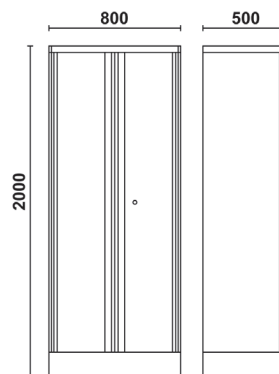

72 kg



C55A1/R42

055000461

Interior shelf for tool cabinet C55A1/C55AT1

30 kg

2,4 kg



400x400 mm

C55A2/R70

055000462

Interior shelf for tool cabinet C55A2/C55AT2

50 kg

3,5 kg



700x400 mm

C55C 055000400

Cargo cabinets

Developed on the basis of accurate research conducted with trained, professional users, they provide ideal solutions for working comfortably and rationally.

The opening system of the perforated panels of the two doors also allows the interior surface to be made the most of.

Main features:

- 1 drawer with ball bearing slides.
- Easy tool layout according to users' needs.
- Easy wall mounting by means of two slots located at the back of the cabinet.
- Safety lock for both drawers and doors.
- Empty thermoformed tray for 1/2" sockets and accessories.



 37 kg

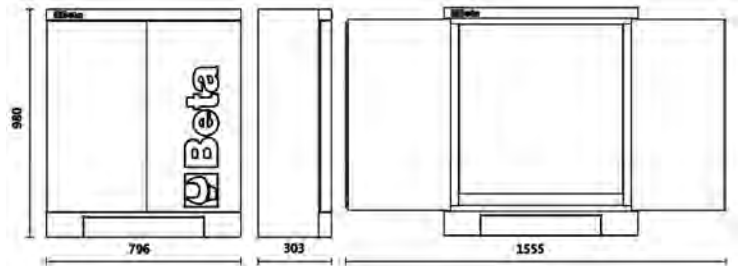

ACCESSORIES AND TOOL HOOKS FOR PERFORATED PANELS



C45LMP 045000320
LED lamp for workshop equipment combination RSC55

- Length: 630 mm
- Easy to fix under wall cabinet through adhesives
- ON/OFF switch
- 570 lumens

Input: 100-240V 0,6A
Output: 12V 1.50A 18.0W



L=45 cm

SPC 088880480

Computer wall bracket

- Matches tool wall systems RSC55
- Dimensions 398x243x138 mm

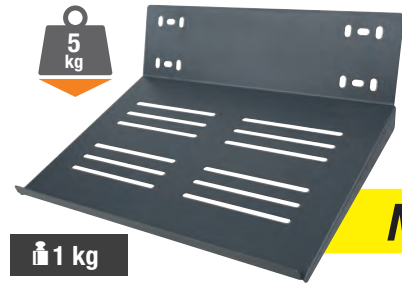

New

CP 088880470
Wall-mounted bottle holder rack, made of steel

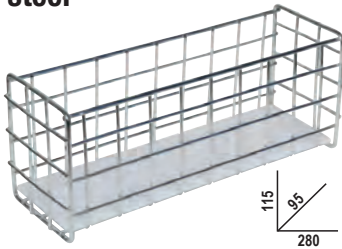

PM/6C 088880440
6-tray tool holder, made of plastic, with support

- Interior dimensions of tray: 80x60 mm



PM/5C 088880450
5-tray tool holder, made of plastic, with support

- Interior dimensions of tray: 95x120 mm



KIT/GPS 088880119

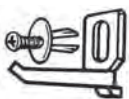

GM 088880250



	Ø
088880250	6,5
088880251	9,5
088880252	13
088880253	16
088880254	19
088880255	25

S55/8 088880420

- 55/S8
- 55AS/8
- 55MP/S8

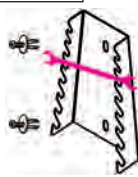

S55/12 088880421

- 55/S12
- 55/S12X
- 55AS/12
- 55MP/S12

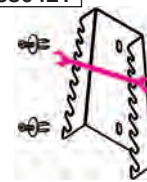

ST2P 088880422

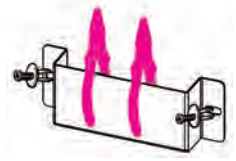

TSPP 088880402

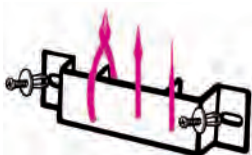

S952/10 088880423

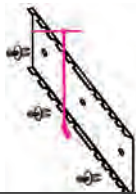

S1719BM 088880404

- 1719BMA: Q-T-P-M-R
- 1719BMD: Q-T-P-M-R

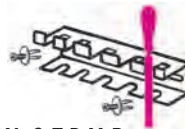

SGN 088880405

- 1290N-1292N-1299N/PZ
- 1260N-1262N-1269N/PZ
- 1201N-1202N-1209N/PZ

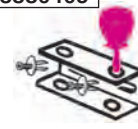

S42/17 088880428

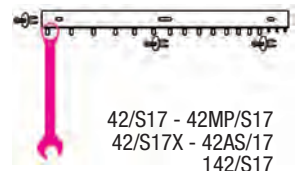

- 42/S17 - 42MP/S17
- 42/S17X - 42AS/17
- 142/S17

S951/6 088880429

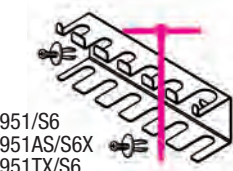

- 951/S6
- 951AS/S6X
- 951TX/S6

SPG11 088880910

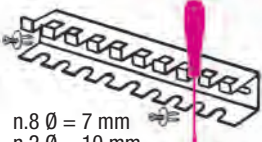

- n.8 Ø = 7 mm
- n.2 Ø = 10 mm
- n.1 Ø = 12 mm

S1203/8 088880430



- 1203/S8
- 1263/D8
- 1293/S8

S96T/8 088880431

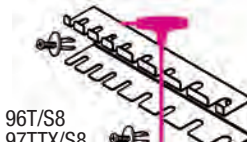

- 96T/S8
- 97TTX/S8
- 96T/AS8

96T/SPV 000960958

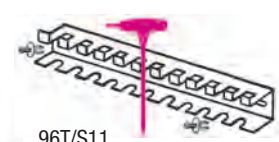

- 96T/S11
- 97TTX/S11

SB

Socket rails



SB1 L 210 mm 088880201

SB2 L 280 mm 088880202

SB3 L 360 mm 088880203

MB

Socket clips for rails SB



MB0 1/4 088880210

MB1 3/8 088880211

MB2 1/2 088880212

YOUR COLOURS FOR YOUR WORKSHOP

RSC55 allows you to order the benches and tool wall system with shutter in a neutral (grey) version and customize the vertical coloured inserts by choosing from 7 different adhesive tapes.



1.

Order your modules in a neutral colour

2.

Order the vertical insert

Now choose the colour to your taste or according to your company's colours.



C55STR

Adhesive tape 25 m

Allows to tailor the vertical tapes of garage furniture item C55

Ral References	Color	Code
2011	Orange	055000901
9006	Grey	055000902
3000	Red	055000903
5015	Blue	055000904
1023	Yellow	055000905
6029	Green	055000906
9016	White	055000907
1035	Gold	055000909



Imagine and create...

Configure your workshop in 3D online

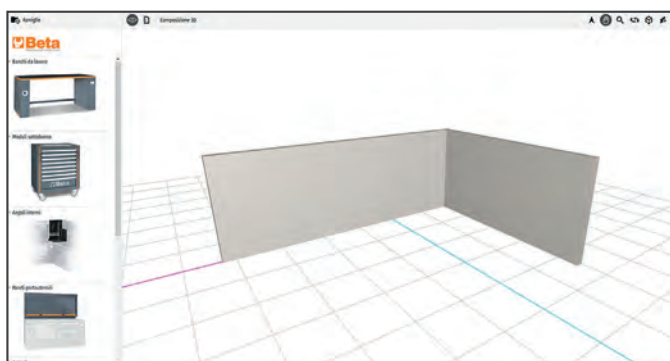

step 1

Draw the walls

Create the walls according to the dimensions of your workshop.

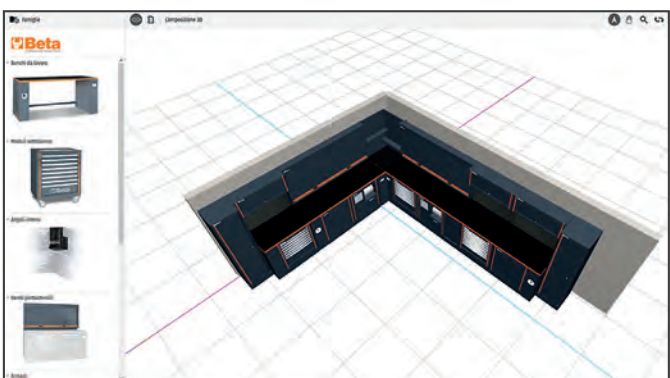
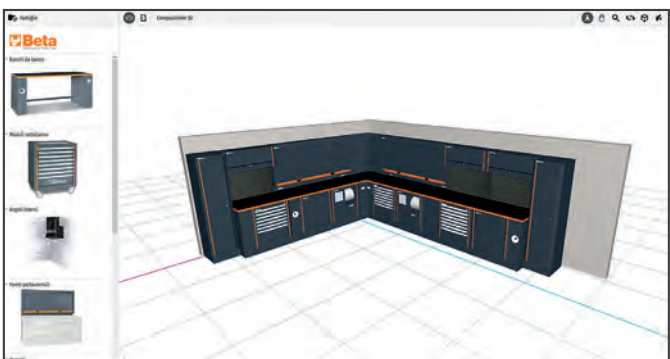

step 3

View the result in 3D

The combination is immediately displayed in 3D and can be viewed from different angles.



step 2

Design your workbench system

Select and assemble the component parts, to make your own combination.

ORDINE		CLIENTE	
Order number		Address	
Date	02 / 12 / 2020	Telephone & fax	
Order content	92 / mm / 8444	Industry	
Quantity		Section	Desk
Color alternative		Name	
Banchi da lavoro			
	Articolo 05000094 Codice C58/044 DESCRIZIONE Gamba universale con avvolgitore elettrico integrato per banco da lavoro arredo ufficio	Quantità: 3 Importo: 0	
	Articolo 05000099 Codice C58/044 DESCRIZIONE Gamba universale per banco da lavoro con avvolgitore integrato	Quantità: 3 Importo: 0	
	Articolo 05000706 Codice C58 PT2 DESCRIZIONE piano di lavoro da 2 metri per banco arredo ufficio	Quantità: 1 Importo: 0	
	Articolo 05000266	Quantità: 2	

step 4

Request a quote

Print the detail of the arrangement in PDF format and take it to your dealer to get a quote.

CUSTOMIZED MODULES ON REQUEST

**SOFT
MODULE
SYSTEM**



Fill your drawers with customized modules in six steps

(Max size: 1100 x 600 mm)

1
Determine your needs
and send your project
to the Beta dealer

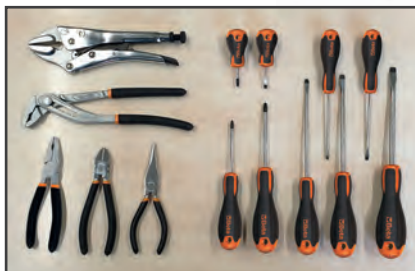

2
We will receive and codify
your initial assortment
of the project

Image	Product	Code Beta
	Self-locking pliers	010540022
	Pliers	010440250
	Pliers	011500046
	Screwdrivers for slotted head screws	012011039
	Screwdrivers for cross head Phillips® screws	012021018

3
We will execute
the design



4
We will submit the final
layout for your approval

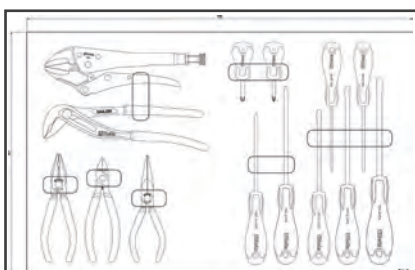

5
We will build the soft
modules in Beta's factory
in Sovico



6
We will deliver the tools
in the customized modules



Contact our dealers
www.beta-tools.com/en/find-a-dealer/

5S

is a workplace organization method of Japanese origin. The name is derived from the western transcription of 5 Japanese words:
seiri, seiton, seiso, seiketsu and shitsuke.



Following the 5 steps identified by the words allows a systematic, repeatable method to be implemented with a view to optimized working standards and enhanced operating performance.



BENEFITS

Reduced time loss and improved cost-effectiveness

A proper organization and transport system for your tools will allow you to have everything you need, where you need it, and within reach.

Enhanced quality and productivity

Standard equipment does not always cater to our needs. Creating your equipment on an item-by-item basis will allow you to fully adapt it to your requirements, which will result in improved reliability and performance.

Fewer work accidents

Most accidents occur while using tools. Arranging all necessary items so that they can be easily selected for use and removing all unnecessary items will allow you to minimize misuse and reduce hazards.

Greater efficiency

Reducing the number of defects and errors will allow you to avoid delays, optimize processes and improve the company's results and efficiency.

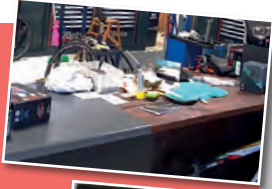

Beta

Winning, together

Fabio Quartararo
MotoGP World Champion 2021



Partnership 2021

0998011179



8 1054809 376950

Beta Utensili S.p.A. | via Volta, 18 | 20845 Sovico (MB) | tel +39 039 20771
www.beta-tools.com

 **HOCOPARTS**
PREMIUM MOTORCYCLE PRODUCTS