

ACE BIKES

CATALOG

2026

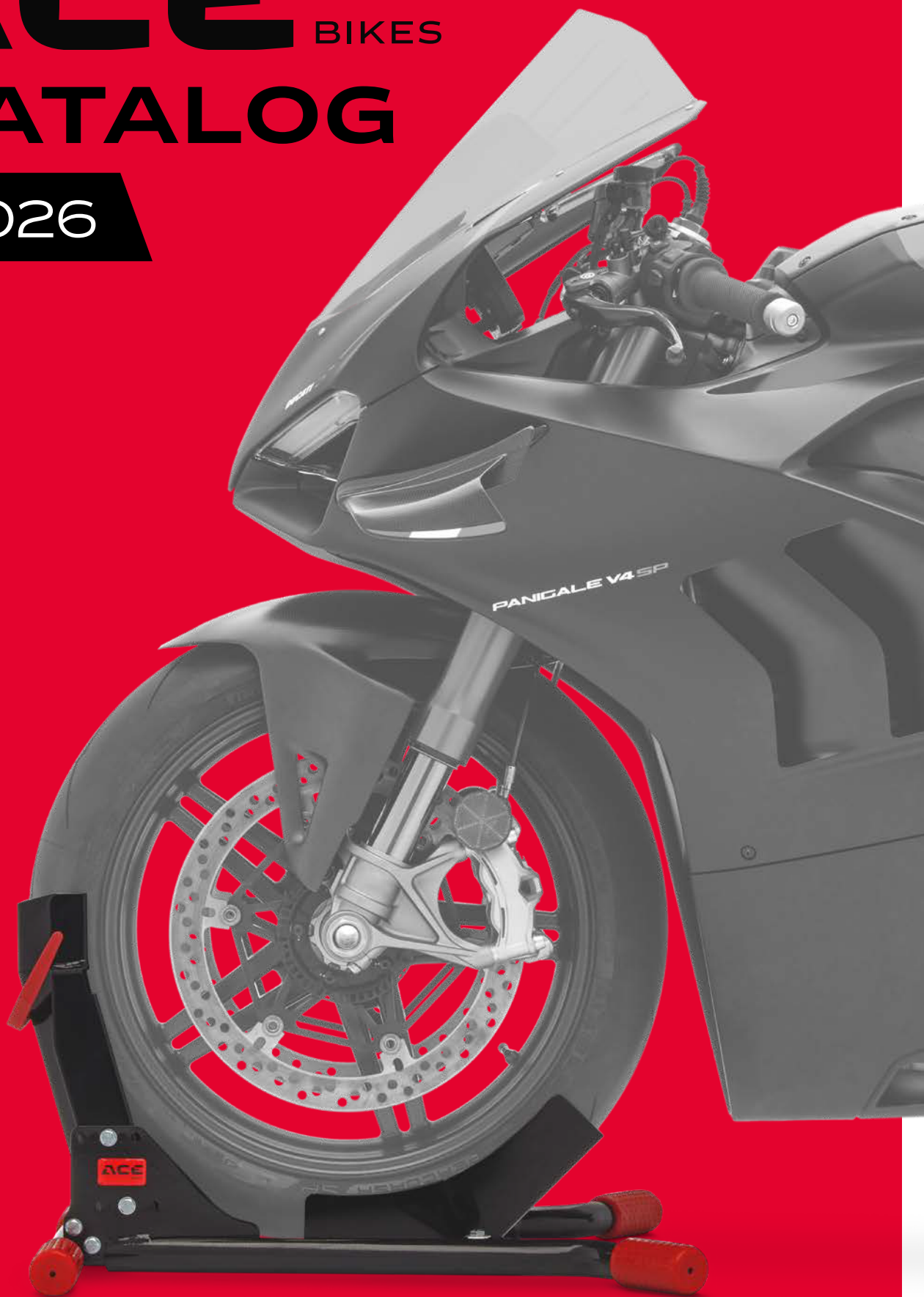

ACEBIKES.COM

HOCOPARTS
PREMIUM MOTORCYCLE PRODUCTS

TRAIL



INDEX

MOTORCYCLE STAND

SteadyStand®	3	SteadyStand® Fixed Scooter	9
SteadyStand® Scooter	5	SteadyStand® Multi Fixed	10
SteadyStand® Multi	6	SteadyStand® Cross	11
SteadyStand® Fixed	7	SteadyStand® Cross Basic	12
		SteadyStand® Cross Flex <small>NEW</small>	13

MOTORCYCLE LASHING

Ratchet Essential	15	Loops Premium	25
Ratchet Pro	17	Multi Hook	26
Ratchet Premium	18	Flexi Rail Rail Set	27
Ratchet Premium Deluxe	19	D-Ring Essential	28
Buckle-Up	20	D-Ring Pro	28
Cam Buckle Essential	21	TyreFix® Essential	29
Cam Buckle Pro	22	TyreFix® Pro	31
Cam Buckle Premium	23	CapStrap	33
Loops Essential	24		
Loops Pro	24		

FOLDABLE RAMP

Ramp Essential	35
Ramp Pro	36
Ramp Pro Max	37
Ramp Compact	38

HANDLING

Bike-A-Side	43
U-Turn Motor Mover L <small>NEW</small>	45
U-Turn Motor Mover XL	46

ACCESSORIES

BrakeFix	39
Moto Carpet XL	41
Parking Pad <small>NEW</small>	42

INFO

Technical Information	47
About us	54

STEADYSTAND®



High quality materials and innovative details makes the Acebikes SteadyStand® the most reliable way to park your motorcycle.

- ⊕ Special rubber feet to prevent sliding
- ⊕ Durable, high quality powder coated material
- ⊕ The secure locking system on the front wheel provides maximum stability



15-19 inch



90-130 mm



STEADYSTAND®

SCOOTER



PARKING

With the SteadyStand Scooter your scooter will be parked in a super stable, immovable position within seconds. Very useful for performing maintenance work on your scooter or just because you don't like jacking up the scooter with the main stand.



- ⊕ Easy to move because of the convenient handle
- ⊕ Durable, high quality powder coated material
- ⊕ Specially designed and engineered for scooters



10-13 inch



80-120 mm

STEADYSTAND®

MULTI



PARKING

With the Acebikes SteadyStand Multi your motorbike is firmly anchored in seconds and is fully adjustable for almost any type of motorcycle front or rear tyre without any tools.



- ⊕ Special rubber feet to prevent sliding
- ⊕ Completely adjustable without tools
- ⊕ Suitable for almost any motorcycle front or rear tyre size



15-21 inch



90-200 mm

STEADYSTAND®

FIXED



The galvanized Acebikes SteadyStand® Fixed is designed to make clever use of gravity and can easily be mounted onto the floor of a trailer or van.



- ⊕ Anchorable on any hard surface
- ⊕ Galvanized for durability
- ⊕ Includes mounting hardware



10-19 inch



90-130 mm

AGF



STEADYSTAND®

FIXED SCOOTER



TRANSPORT

The only thing left is to put the straps onto your scooter for a total secured position. The galvanized Acebikes SteadyStand® Fixed Scooter can easily be mounted onto the floor of a trailer or van.

- ⊕ Galvanized for durability
- ⊕ Anchorable on any hard surface
- ⊕ Specially designed and engineered for scooters



10-13 inch



80-120 mm

STEADYSTAND®

MULTI FIXED



TRANSPORT

The galvanized Acebikes SteadyStand Multi Fixed is designed to make clever use of gravity during transport and is fully adjustable for almost any type of motorcycle front or rear tyre without any tools.

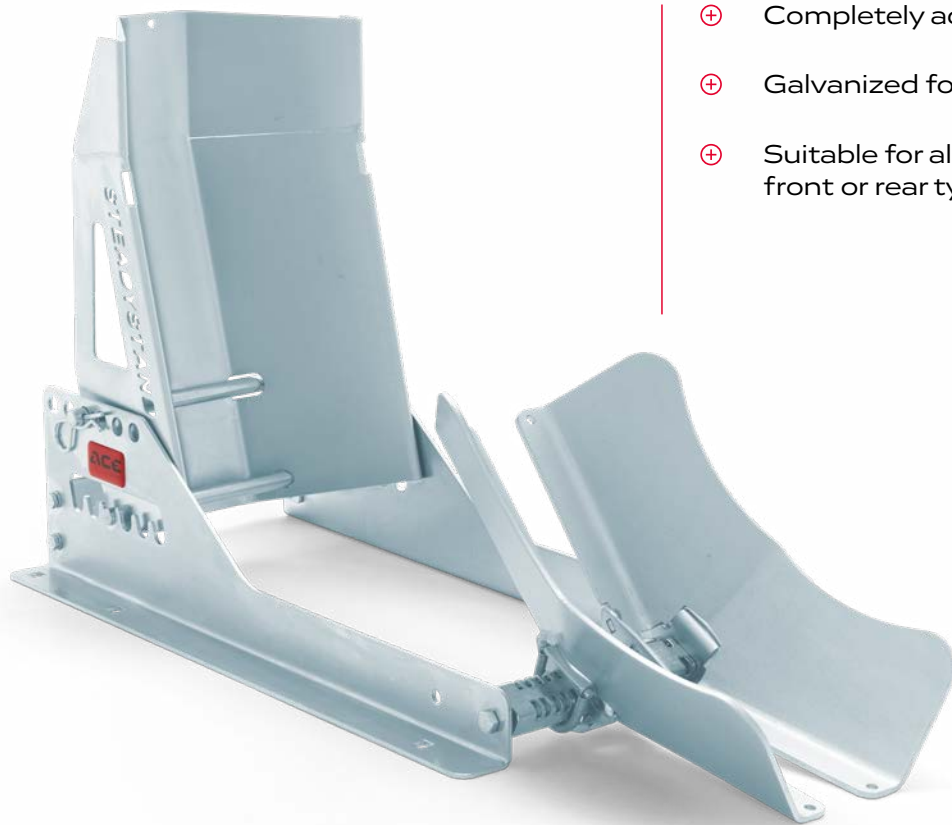

- ⊕ Completely adjustable without tools
- ⊕ Galvanized for durability
- ⊕ Suitable for almost any motorcycle front or rear tyre size



15-21 inch



90-200 mm

STEADYSTAND®

CROSS



The galvanized Acebikes SteadyStand® Cross is especially developed for enduro and dirtbikes and is the ultimate help during transport on trailers, pickups and vans.

- ⊕ Secure foot pedal lock-system
- ⊕ Keyholes in the sideframe for easy removal
- ⊕ By using the SteadyStand® Cross, you will only have to use tiedowns to secure the rear end of your motorbike



18-21 inch



90-120 mm

STEADYSTAND®

CROSS BASIC



TRANSPORT

The SteadyStand Cross® Basic makes clever use of gravity, which will ensure your dirtbike from not moving or leaning over when you are securing your dirtbike on a trailer, pick-up or van.



- ⊕ Durable galvanized materials
- ⊕ Specially developed for Enduro and Dirtbikes
- ⊕ Holds the Dirtbike upright for easy lashing and securing



18-21 inch



90-120 mm

STEADYSTAND®

CROSS FLEX



The Acebikes SteadyStand® Cross Flex offers maximum flexibility for every dirt bike and enduro rider. Whether you need upright parking without a kickstand, a stable position for maintenance and cleaning, or secure support during transport.

- ⊕ Keeps the motorbike perfectly upright
- ⊕ Quick and simple to place and remove the bike
- ⊕ Strong and stable construction based on proven SteadyStand designs



18-21 inch



90-120 mm

ACE



RATCHET

ESSENTIAL



Also available separately
Strapbinders



TRANSPORT

The Acebikes Ratchet Essential 2-Pack is your essential piece of equipment to secure your motorcycle or scooter. Its continuous loop design makes it easy to find a suitable hooking point.



- ⊕ Solid Essential Ratchets
- ⊕ Continuous loop design
- ⊕ Comes with two Velcro strap binders and a handy carrying bag



350 daN



250 cm



2,5 cm



Tidy your leftover strap with
INCLUDED STRAPBINDERS

RATCHET

PRO



The Ratchet Pro is perfect for securing any type of motorcycle. The solid plasticized hooks are provided with locking clips for extra security. The loops create a hook point on your motorcycle anywhere you want.



- ⊕ High quality Ratchets Pro
- ⊕ Two Loops Essential included
- ⊕ Comes with two Velcro strap binders and a handy carrying bag



350 daN



140 cm

2,5 cm



RATCHET

PREMIUM



TRANSPORT

Practical and very strong straps made of high-quality polyester. These 200 cm long polyester straps are equipped with a galvanized, plasticized hook and allows for secure and reliable fastening during transport.



- ⊕ Premium 750 daN Ratchets
- ⊕ Sewn-in Soft Hook for easy application
- ⊕ Comes with handy carrying bag and velcro strap binders



750 daN



200 cm



3 cm

RATCHET

PREMIUM DELUXE



TRANSPORT

Practical, extra strong heavy-duty belt made of high quality polyester with a premium heavy-duty ratchet. Especially designed for transporting heavy motorcycles.



- ⊕ Sewn-in Soft Hook for easy application
- ⊕ Integrated simulated Sheepskin Sleeve
- ⊕ Comes with Velcro strap binders and a handy carrying bag



900 daN



200 cm

3,8 cm

BUCKLE-UP



The Buckle-up, with its practical straps that are both long and wide, is your essential piece of equipment to make motor handling easy and trouble-free.



- ⊕ All-in one handlebar tiedown solution
- ⊕ Protects with the integrated simulated sheepskin sleeve



CAM BUCKLE

ESSENTIAL



TRANSPORT

The Cam Buckle Essential is your essential piece of equipment to secure your motorcycle or scooter. Its continuous loop design makes it easy to find a suitable hooking point in any situation.



- ⊕ Solid Essential Cam Buckles
- ⊕ Continuous loop design
- ⊕ Comes with handy carrying bag and strap binders



300 daN



250 cm



2,5 cm



CAM BUCKLE

PRO



TRANSPORT

Perfect for securing any type of motorcycle. The solid plasticized hooks are provided with resilient locking clips for extra security. Guarantees durability and heavy-duty work load. With the loops you can create a hook point anywhere you want.



- ⊕ Heavy duty plasticized hooks
- ⊕ Resilient locking clips for extra security
- ⊕ Comes with two loops, velcro strap binders and a handy carrying bag



300 daN



140 cm



2,6 cm

CAM BUCKLE

PREMIUM



TRANSPORT

Equipped with Premium Cam Buckles and integrated sewn-in loops this high-quality solution will fulfill any transportation needs. A multipurpose solution for medium to heavy motorcycles or scooters.



- ⊕ Sewn-in soft hook for safe application
- ⊕ Equipped with Premium Cam Buckles
- ⊕ Plasticized hooks with resilient locking clips for extra security



350 daN



200 cm



3 cm

LOOPS

ESSENTIAL



TRANSPORT

With the Acebikes Loops Essential, you can create a hookpoint on your motorcycle anywhere you want, these are built to last.



KG

450 daN

H 3 cm

LOOPS

PRO



TRANSPORT

With the extra wide Loops Pro, you can create a hookpoint anywhere you want, to attach your lashing without risking any kind of damage to your motorcycle.



KG

680 daN

H 3,8 cm



LOOPS

PREMIUM



With the Acebikes Loops Premium, you can create a hook point on your motorcycle anywhere you want. The protected sleeve prevents scratching your bike and the Loops also comes with a convenient storage bag.



- ⊕ Create extra protective hook points
- ⊕ Faux Sheepskin to prevent scratches and damage



Comes with convenient
Storage bag



680 daN

3,8 cm

MULTI HOOK



Create an anchor point anywhere you want to tie down your motorcycle easily and securely on any trailer or vehicle. The Acebikes Multi Hook can be used in complement to any tie down solution.



- ⊕ Durable, fully galvanized and plasticized hooks.
- ⊕ Made of solid steel, high strength
- ⊕ Can be used on trailers or other transport vehicles with holes to create convenient hooking points



FLEXI RAIL

RAIL SET



The sturdy tie-down rails, made of galvanized steel, are bolted to the floor of the trailer or van. This enables you to attach tie-down straps securely and in any position you wish.



Also available separately
Flexi Rail Expansion Set

- ⊕ Fully galvanized steel to prevent rust
- ⊕ Can be secured at different point
- ⊕ Sold in pairs, including 4x carabines and fittings



245 daN per carabiner

D-RING

ESSENTIAL



The 4 pack D-ring Essential mounts can be folded flat when not in use.



D-RING

PRO



Heavy-Duty D-Rings Pro mounting plate may be folded flat when not in use.



TYREFIX®

ESSENTIAL



Also available separately
Tyrefix® Ratchets



TRANSPORT

The Acebikes TyreFix Essential is a tie-down set with a special tie-down trap system for securing any type of motorbike on a trailer, van or transporter.



- ⊕ Easy to attach
- ⊕ Special friction material
- ⊕ Suitable for almost every tyre size



500 daN



TYREFIX®

PRO



TRANSPORT

The Acebikes TyreFix Pro is the tie-down system for easily and secure transporting any type of motorcycle on a transporter, van or trailer.



- ⊕ Special friction materials for maximum security during transport
- ⊕ Made of high-quality materials
- ⊕ Including unique integrated Ratchets



500 daN



ICE
BIKES

ROSSO CORSA II

DIABLO

DOT EPR 18 5555

DOT EPR 18 5555

DOT EPR 18 5555

DOT EPR 18 5555

DOT EPR 18 5555



ACE
Bikes

170/60 R 17

PERZ
170E PERZ
170E 17

MADE IN
INDONESIA

CAPSTRAP

For **BMW**



The CapStrap open axle tie-down system is designed for BMW motorcycles with 5,3 cm hollow axles.



- ⊕ No load on your suspension systems
- ⊕ High quality ABS material to prevent scratching
- ⊕ Minimal interference with your exhaust or your bike cases



KG

500 daN



135 cm



5,3 cm

RAMP

ESSENTIAL



TRANSPORT

This Essential Foldable Loading Ramp is an extremely sturdy and firm ramp, made of high quality aluminium. Suitable for all motorcycles weighing up to 340 kg.



- ⊕ Light weight, only 7,3 kg
- ⊕ High quality aluminium
- ⊕ Special plastic parts to prevent scratches and damage



Also available with a handy
Ramp Carry Bag



KG

Max. 340 kg



220 cm



28 cm

RAMP

PRO



TRANSPORT

This premium quality ramp is suitable for all motorbikes weighing up to 680kg and makes loading and unloading of your motorbike as simple as it can possibly be. The material of the ramp is made from high quality aluminium, but with a weight of only 12 kg.



- ⊕ Heavy-Duty yet lightweight construction
- ⊕ Fully closed surface for extra grip
- ⊕ Suitable for all motorbikes weighing up to 680 kg



Max. 680 kg



223 cm



28,5 cm

RAMP

PRO MAX



TRANSPORT

The extra-width construction of no less than 57 cm provides a comfortable level of access to the ramp. Equipped with a useful handle as well as a fully closed surface for additional grip and durability, this ramp is your must-have tool for easy loading.



- ⊕ Equipped with easy to use handle
- ⊕ Extra width construction
- ⊕ Suitable for all motorbikes weighing up to 500 kg



Max. 500 kg



224 cm



57 cm



RAMP

COMPACT



Opt for premium quality thanks to durable materials and convenient storage. Made of premium quality aluminium, and with a weight of only 8,6 kg this compact ramp is the ideal solution.



- ⊕ Space saving folding design
- ⊕ Strong yet lightweight aluminium
- ⊕ Comes with practical carry bag



Max. 300 kg



199 cm

25 cm



BR KEFIX

BRAKEFIX



Brakefix is used to lock the front brake for any type of motorbike. It is easy to use, with a simple but secure click-to-lock system.

- ⊕ Durable and extremely rigid
- ⊕ Suitable for every motorcyclist
- ⊕ Click-to-lock system

MOTO CARPET

XL



Protect your garage or workshop floor in style with the Moto Carpet XL from Acebikes. This extra-large 2,5m long, moisture-absorbing mat is designed to keep your space clean and dry.



- ⊕ Extra large moto carpet
- ⊕ Moisture absorbing material
- ⊕ Suitable for any motorcycle



PARKING PAD



Crafted from durable, lightweight plastic material, this large pad ensures your bike's kickstand stays secure on soft surfaces like grass, gravel, or hot asphalt, preventing costly tip-overs.



- ⊕ Durable and rigid material
- ⊕ Light weight
- ⊕ Features a large textured surface to grip the ground firmly





- ⊕ Built for motorcycles with weighing up to 450 kg
- ⊕ Ball Bearing swivel wheels for smooth maneuvering



Max. 450 kg

BIKE-A-SIDE



The Acebikes Bike-A-Side motorcycle dolly is the perfect solution for maneuvering motorcycles with center stands.

U-TURN

MOTOR MOVER L



The easiest way to maneuver your motorcycle with kickstand in garages and tight places. Just lift and GO! The U-turn Motor Mover L is adjustable without tools and is therefore easy to adjust.



- ⊕ Foldable for easy storage
- ⊕ Adjustable without tools
- ⊕ Easily lift and move your motorcycle



Max. 300 kg



132 - 165 cm



Max. 221 cm

U-TURN

MOTOR MOVER XL



The need to ride your motorcycle onto the dolly itself has been eliminated, making your life easier. Fitted with swivel wheels, the motorcycle dolly is perfect for use in narrow spaces.

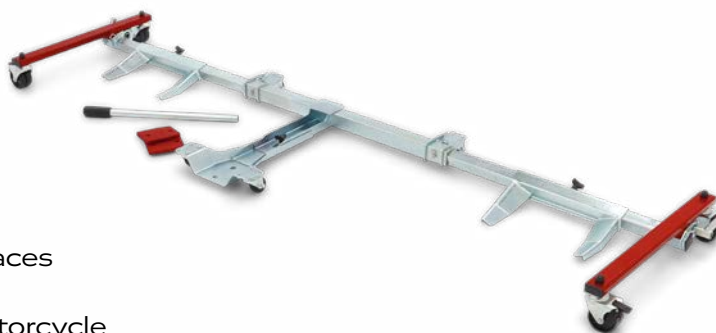

- ⊕ Perfect for use in narrow spaces
- ⊕ Easily lift and move your motorcycle
- ⊕ Suitable for motorcycles weighing up to 450 kg

KG Max. 450 kg

 125,5 - 180 cm

 Max. 250 cm

STEADYSTAND®



Article information

Model nr:
250 / 1021

Model description:
SteadyStand®

Color:
Black

Accessories:
Wheel strap

Technical information

Material:
Steel

Material processing:
Powdercoated

Net weight:
7 kg

Product size (LxWxH):
61 x 52 x 35 cm



15-19 inch



90-130 mm

STEADYSTAND®

SCOOTER



Article information

Model nr:
260 / 1023

Model description:
SteadyStand® Scooter

Color:
Grey

Accessories:
Wheel strap

Technical information

Material:
Steel

Material processing:
Powdercoated

Net weight:
5 kg

Product size (LxWxH):
49 x 47 x 29 cm



10-13 inch



80-120 mm

STEADYSTAND®

MULTI



Article information

Model nr:
180 / 1022

Model description:
SteadyStand® Multi

Color:
Black

Accessories:
Wheel strap

Technical information

Material:
Steel

Material processing:
Powdercoated

Net weight:
10 kg

Product size (LxWxH):
70 x 61 x 38 cm



15-21 inch



90-200 mm

STEADYSTAND®

FIXED



Article information

Model nr:
152 / 1024

Model description:
SteadyStand® Fixed

Color:
Zinc

Accessories:
Mounting Hardware

Technical information

Material:
Steel

Material processing:
Galvanized

Net weight:
5 kg

Product size (LxWxH):
62 x 21 x 38 cm



10-19 inch



90-130 mm

STEADYSTAND®

FIXED SCOOTER



Article information

Model nr:
153 / 1026

Model description:
SteadyStand® Fixed Scooter

Color:
Zinc

Accessories:
Mounting Hardware

Technical information

Material:
Steel

Material processing:
Galvanized

Net weight:
3,5 kg

Product size (LxWxH):
50 x 19 x 30,5 cm



10-13 inch



80-120 mm

STEADYSTAND®

MULTI FIXED



Article information

Model nr:
181 / 1025

Model description:
SteadyStand® Multi

Color:
Zinc

Accessories:
Mounting Hardware

Technical information

Material:
Steel

Material processing:
Galvanized

Net weight:
8 kg

Product size (LxWxH):
65,5 x 28 x 38 cm



15-21 inch



90-200 mm

STEADYSTAND®

CROSS



Article information

Model nr:
190 / 1027

Model description:
SteadyStand® Cross

Color:
Zinc

Accessories:
Mounting Hardware

Technical information

Material:
Steel

Material processing:
Galvanized

Net weight:
10 kg

Product size (LxWxH):
60 x 37 x 75 cm



18-21 inch



90-120 mm

STEADYSTAND®

CROSS BASIC



Article information

Model nr:
191 / 1028

Model description:
SteadyStand® Cross Basic

Color:
Zinc

Accessories:
Mounting Hardware

Technical information

Material:
Steel

Material processing:
Galvanized

Net weight:
8 kg

Product size (LxWxH):
54 x 25 x 75 cm



18-21 inch



90-120 mm

STEADYSTAND®

CROSS FLEX



Article information

Model nr:
192 / 1029

Model description:
SteadyStand® Cross Flex

Color:
Red, Black

Technical information

Material:
Steel

Material processing:
Powdercoated

Net weight:
9 kg

Product size (LxWxH):
69 x 58 x 75 cm



18-21 inch



90-120 mm

RATCHET

ESSENTIAL



Article information

Model nr:
2021

Model description:
Ratchet Essential 2-Pack

Included:
2x Ratchet Essential

2x Velcro strap binder

1x Storage bag

Technical information

Strap Length:
250 cm

Strap Width:
2,5 cm

Load Capacity:
350 daN



350 daN



250 cm



2,5 cm

RATCHET

PRO



Article information

Model nr:
2023

Model description:
Ratchet Pro 2-Pack

Included:
2x Ratchet Pro

2x 140 cm webbing with hooks

2x Velcro strap binder

1x Storage bag

Technical information

Strap Length:
140 cm

Strap Width:
2,5 cm

Load Capacity:
350 daN



350 daN



140 cm



2,5 cm

RATCHET

PREMIUM



Article information

Model nr:
2025

Model description:
Ratchet Premium 2-Pack

Included:
2x Ratchet Premium

2x 200 cm webbing with integrated loop and soft hook

2x Velcro strap binder

1x Storage bag

Technical information

Strap Length:
200 cm

Strap Width:
3 cm

Load Capacity:
750 daN



750 daN



200 cm



3 cm

RATCHET
PREMIUM DELUXE



Article information

Model nr:
2027

Model description:
Ratchet Premium Deluxe 2-Pack

Included:
2x Ratchet Premium Deluxe

2x 200 cm webbing with integrated loop and simulated sheepskin

2x Velcro strap binder

1x Storage bag

Technical information

Strap Length:
140 cm

Strap Width:
2,5 cm

Load Capacity:
350 daN

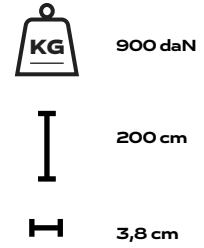

BUCKLE-UP



Article information

Model nr:
4024

Model description:
Buckle-Up

Included:
2x Buckle-Up

1x Storage bag

Technical information

Strap Length:
360 cm

Strap Width:
3,5 cm

Load Capacity:
300 daN

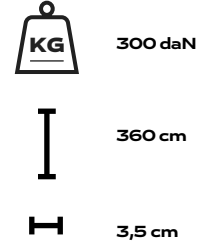

CAM BUCKLE
ESSENTIAL



Article information

Model nr:
3021

Model description:
Cam Buckle Essential 2-Pack

Included:
2x Cam Buckle Essential

2x Velcro Strap binder

1x Storage bag

Technical information

Strap Length:
250 cm

Strap Width:
2,5 cm

Load Capacity:
300 daN

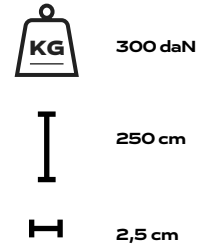

CAM BUCKLE
PRO



Article information

Model nr:
3023

Model description:
Cam Buckle Pro 2-Pack

Included:
2x Cam Buckle Pro

2x Loop Essential

2x 140 cm webbing with hooks

2x Velcro Strap binder

1x Storage bag

Technical information

Strap Length:
140 cm

Strap Width:
2,6 cm

Load Capacity:
300 daN

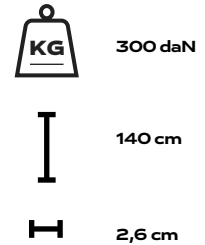

CAM BUCKLE
PREMIUM



Article information

Model nr:
3025

Model description:
Cam Buckle Premium 2-Pack

Included:
2x Cam Buckle Premium

2x 200 cm webbing with integrated loop and soft hook

2x Velcro Strap binder

1x Storage bag

Technical information

Strap Length:
200 cm

Strap Width:
3 cm

Load Capacity:
350 daN

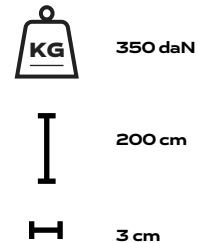

LOOPS
ESSENTIAL



Article information

Model nr:
4027

Model description:
Loops Essential

Included:
2x Loops Essential

Technical information

Strap Width:
3 cm

Load Capacity:
450 daN

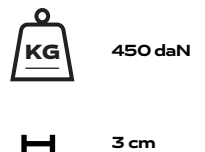

LOOPS

PRO



Article information

Model nr:
4028

Model description:
Loops Pro

Included:
2x Loops Pro

Technical information

Strap Width:
3,8 cm

Load Capacity:
680 daN



680 daN



3,8 cm

LOOPS

PREMIUM



Article information

Model nr:
4029

Model description:
Loops Premium

Included:
2x Loops Premium
1x Storage Bag

Technical information

Strap Width:
3,8 cm

Load Capacity:
680 daN



680 daN



3,8 cm

FLEXI RAIL

RAIL SET



Article information

Model nr:
5023

Model description:
Flexi Rail - Rail Set

Color:
Zinc

Included:
2x Flexi Rail
4x Carabines
18x Fittings

Technical information

Material:
Steel

Material processing:
Galvanized

Net weight:
2,7 kg

Product size (LxWxH):
78,5 x 5 x 1 cm

Load capacity:
245 daN per carabiner



245 daN
per carabiner

FLEXI RAIL

EXPANSION SET



Article information

Model nr:
5024

Model description:
Flexi Rail - Expansion Set

Included:
4x Carabines
4x Fitting Plate

Technical information

Material:
Steel

Material processing:
Galvanized

Net weight:
0,85 kg

Product size (LxWxH):
9 x 4,5 x 3,5 cm

Load capacity:
245 daN per carabiner



245 daN
per carabiner

D-RING

ESSENTIAL



Article information

Model nr:
5021

Model description:
D-Ring Essential

Included:
4x D-Ring Essential
8x Lock Nuts
8x M6 Head Bolts
8x Large Washer
8x Small Washer

Technical information

Material:
Steel

Material processing:
Zinc Plated

Product size (LxWxH):
7 x 4 x 1 cm

Load capacity:
550 daN



550 daN

D-RING

PRO



Article information

Model nr:
5022

Model description:
D-Ring Pro

Included:
2x D-Ring Pro
4x Lock Nuts
4x M10 Head Bolts
4x Washer

Technical information

Material:
Steel

Material processing:
Zinc Plated

Product size (LxWxH):
10 x 6 x 1,8 cm

Load capacity:
2250 daN



2250 daN

TYREFIX

ESSENTIAL



Article information

Model nr:
4021

Model description:
TyreFix® Essential

Included:
1x TyreFix® Essential

*TIE DOWN STRAPS NOT INCLUDED

Technical information

Material:
Polyester

Net weight:
1 kg

Load capacity:
500 daN



500 daN

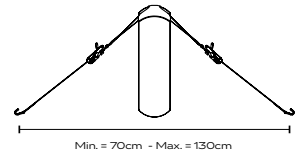

TYREFIX

RATCHETS



Article information

Model nr:
4030

Model description:
TyreFix® Ratchets

Included:
2x TyreFix® Ratchets

1x Required Tools

Technical information

Net weight p.p.:
0,5 kg

Straps Width:
3 cm



3 cm

TYREFIX

PRO



Article information

Model nr:
4022

Model description:
TyreFix® Pro

Included:
1x TyreFix® Pro

1x Storage Bag

Technical information

Material:
Polyester

Net weight:
1 kg

Load capacity:
500 daN

Straps length:
65 cm



500 daN

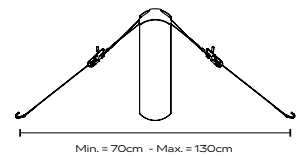

CAPSTRAP



Article information

Model nr:
8095

Model description:
CapStrap

Included:
2x CapStrap

1 Storage Bag

Technical information

Strap length:
135 cm

Cap Material:
ABS + TPU



500 daN



135 cm



5,3 cm

MULTI HOOK



Article information

Model nr:
5025

Model description:
Multi Hook

Included:
2x Multi Hook

Technical information

Material:
Steel

Material processing:
Zinc Plated / Plasticized

Net weight p.p.:
0,10 kg

Load Capacity:
1200 daN



1200 daN

BRAKEFIX



Article information

Model nr:
4025

Model description:
BrakeFix

Color:
Red. Black

Technical information

Material:
Plastic

Product size (LxWxH):
10 x 8 x 3 cm

MOTO CARPET

XL



Article information

Model nr:
8021

Model description:
Moto Carpet XL

Color:
Red, Black

Technical information

Material:
PP

Net weight:
4 kg

Product size (LxWxH):
250 x 100 x 1,5 cm

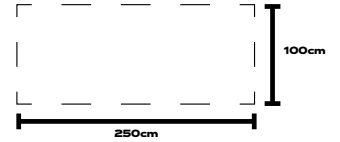

PARKING PAD



Article information

Model nr:
4043

Model description:
Parking Pad

Color:
Red, Black

Technical information

Material:
Nylon

Net weight:
0,080 kg

Package Dimensions (LxWxH):
24,5 x 14,5 x 1,4 cm

BIKE-A-SIDE



Article information

Model nr:
520 / 6021

Model description:
Bike-A-Side®

Color:
Red, Zinc

Accessories:
Position Memory Pad

Technical information

Material:
Steel

Material processing:
Powdercoated

Net weight:
16,5 kg

Product size (LxWxH):
49 x 85 x 10 cm

Max weight:
450 kg



Max. 450 kg

U-TURN

MOTOR MOVER L



Article information

Model nr:
503 / 6022

Model description:
U-Turn® Motor Mover

Color:
Red, Zinc

Technical information

Material:
Steel

Material processing:
Galvanized / Powdercoated

Net weight:
19 kg

Product size Unfolded (LxWxH):
222 x 23 x 63 cm

Max weight:
275 kg



Max. 450 kg



130 - 152 cm



Max. 210 cm

U-TURN

MOTOR MOVER XL



Article information

Model nr:
504 / 6023

Model description:
U-Turn® Motor Mover XL

Color:
Red, Zinc

Technical information

Material:
Steel

Material processing:
Galvanized / Powdercoated

Net weight:
27 kg

Product size Unfolded (LxWxH):
255 x 73 x 15 cm

Max weight:
450 kg



Max. 450 kg



125,5 - 180 cm



Max. 250 cm

RAMP

ESSENTIAL



Article information

Model nr:
7071

Model description:
Ramp Essential

Technical information

Material:
Aluminium

Net weight:
7,3 kg

Product size Unfolded (LxW):
220 x 28 cm

Product size Folded (LxW):
114 x 28 cm

Load capacity:
340 kg



Max. 340 kg



220 cm



28 cm

RAMP

PRO



Article information

Model nr:
7072
Model description:
Ramp Pro

Technical information

Material:
Aluminium
Net weight:
12 kg
Product size Unfolded (LxW):
223 x 28,5 cm
Product size Folded (LxW):
114 x 28,5 cm
Load capacity:
680 kg



Max. 680 kg



223 cm



28,5 cm

RAMP

PRO MAX



Article information

Model nr:
7073
Model description:
Ramp Pro Max

Technical information

Material:
Aluminium
Net weight:
16,5 kg
Product size Unfolded (LxW):
224 x 57 cm
Product size Folded (LxW):
114 x 57 cm
Load capacity:
500 kg



Max. 500 kg



224 cm



57 cm

RAMP

COMPACT



Article information

Model nr:
7074
Model description:
Ramp Compact
Included:
1x Ramp Compact
1x Carry Bag Compact

Technical information

Material:
Aluminium
Net weight:
8,6 kg
Product size Unfolded (LxW):
199 x 25 cm
Product size Folded (LxWxH):
72 x 25 x 21 cm
Load capacity:
300 kg



Max. 300 kg



199 cm



25 cm

RAMP

CARRY BAG



Article information

Model nr:
7075
Model description:
Ramp Carry Bag

Technical information

Material:
Textile
Net weight:
0,66 kg
Product size (LxWxH):
120 x 17 x 32 cm

STRAPBINDERS



Article information

Model nr:
4031
Model description:
Strapbinders
Included:
2x Strapbinder

ABOUT US

Acebikes is a Dutch company, founded in 2007, specialised in designing and developing innovative accessories for every type of motorcyclist.

With years of experience in the field of motorcycle transport, there are several products that facilitate the life of a motorcyclist. Quality, ease of use and constant innovation are the key words when it comes to Acebikes products. That is why we see our products not only as a product. We see them as a complete solution. Anno 2025 Acebikes is ready for the future, where we respond to the needs of today's motorcyclist through constant research and user experience.

OUR GOAL

Our aim is to help all types of motorcyclists with their transport, parking and manoeuvring needs. Whether you ride an enduro, racer, cruiser, scooter or tourer. We want to make all the products you need, with the best quality.

We'll get you there!

For the full **Acebikes**
products experience,
visit our website:

www.cebikes.com

or scan the QR code



**FOLLOW US ON OUR
SOCIAL NETWORKS**



@cebikes.official