

Security Tech Germany



# MOBILE SECURITY CATALOGUE 2022

LOCKS

## Advantages of the new 2022 catalogue

- Find products quicker and more easily
- Product features instantly visible



Learn more inside!

# PICTOGRAMS



**New product**



**New colour**

## LOCKS



### **Double locking**

Dual locking of the shackle in the lock body



### **Pocket size**

Lock in small format



### **XL size**

Lock in large format



### **LED key**

Lighted key included



### **Automatic locking**

No active locking with a key required



### **Robust webbing**

High-tech mesh, durable and hydrophobic



### **Individual code**

Combination code can be freely selected



### **Rechargeable**

Rechargeable battery



### **Battery**

Including battery



### **SmartX**

Innovative locking system, controlled via smartphone



### **XPlus**

Picking-resistant disc cylinder „XPlus“



### **Lightweight**

Lightweight lock, ideal for performance riders



### **Alarm**

Lock with 100 dB alarm function



### **OEM**

Locks are delivered without sales packaging so they can be mounted more quickly. Ideal for use in workshops



### **One Key Option**

Multiple locks can be produced keyed alike and thus operated with one key

## DISCOVER THE NEW 2022 CATALOGUE!

We are pleased that you are holding the new ABUS General Catalog 2022 in your hands and for it to provide you with an overview of our existing products as well as new products.

We are continuously striving to optimize the catalog. From now on, you will find an overview of all related products at the beginning of each chapter for a better overview. The page number on which the product can be found is indicated, allowing you to navigate even faster to the respective product.

We have redesigned the helmet chapter so that you can now find all colors of a product on one page and no longer have to scroll.

As usual, you will also find additional pages on helpful and exciting topics.

We hope that you will enjoy working with the catalog every day and that it will serve as a helpful basis for your work.

*Your mobile security team*



# CONTENTS

Partner Portal .....	004
ABUS Academy .....	006
ABUS - Made in Germany .....	008
Approvals .....	009
Keyless is more .....	010
U-Shackle locks .....	012
Folding locks .....	028
Chain locks .....	048
Steel-O-Flex locks .....	076
Coil cable and cable locks .....	086
Frame locks and battery locks .....	102
Special security .....	120
Brackets and Bags .....	144
Sales Displays and POS .....	164
One Key™ .....	174
Key Service .....	176
The ABUS Level System .....	178
ABUS OEM .....	180
Sponsoring .....	182
Index .....	184

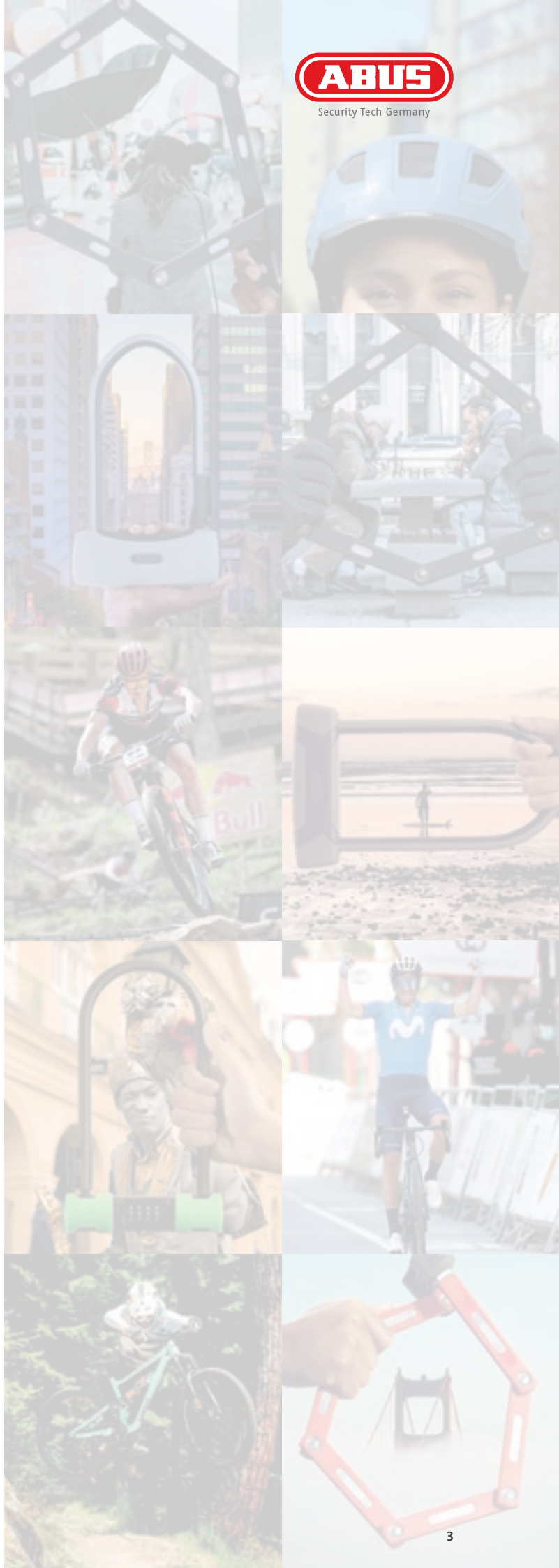

# DISCOVER OUR PARTNER PORTAL

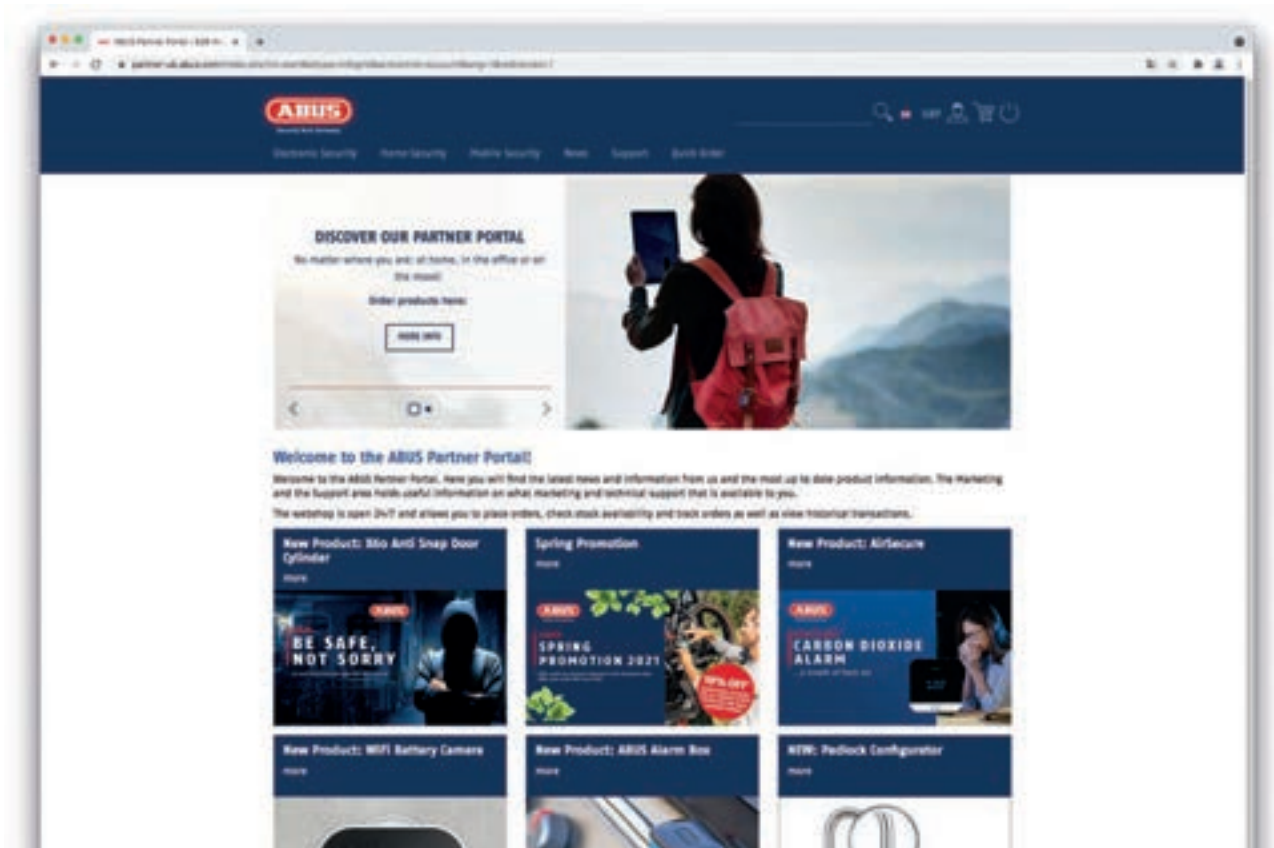

Ordering has never been easier.

Search, click, select variant(s), add to shopping cart, done.

Plus suggestions for similar products or accessories and a handy comparison table.

Everything you could ask for!



## NOTE ON REGISTRATION

If you have a customer and invoice number with ABUS KG or have a registration password, you can easily register in our ABUS Partner Portal and conveniently place orders - anytime and from anywhere.



## OPTIMIZED FOR ALL DEVICES

Order anytime and anywhere. Whether you're using a tablet, smartphone, laptop, or PC, the view is always perfectly sized for your device.

Order 24 hours a day, no matter where you are.\*



## YOUR PERSONAL ORDER LISTS

Customized for you.

Create custom shopping carts for standard orders.

Check shipment status on shipped orders and product availability - easily and reliably.

## YOUR ADVANTAGES:

- Exclusive web store promotions through the online partner's newsletter
- Promote services with practical ad templates
- Download current brochures and mail to customers or print yourself
- Service area with wide range of materials for your sales support
- Design brochures or websites with our images
- Easily connect common merchandise management systems using the velo.connect interface
- Product and application images in print quality
- Download assembly and promotional videos and play them in the store



### OPEN ORDER ITEMS

You have an up-to-date overview of your orders at all times. Get a convenient up-to-date overview of your open order items.



### INTELLIGENT SEARCH

Find the products you want faster than ever. Both a free text and keyword search, as well as filtering by product characteristics, will help you find the product faster and without mistakes. Of course, you can also enter the item number or EAN.



### KEY SERVICE

Order duplicate and replacement keys for your customers conveniently online. To do this, select the correct key blank and enter the key number. We will then be happy to make the key for you.



### LABELS

Download product information and price labels individually, matching your product portfolio, and expand your POS presence. You can find instructions on how to do this in the service area.

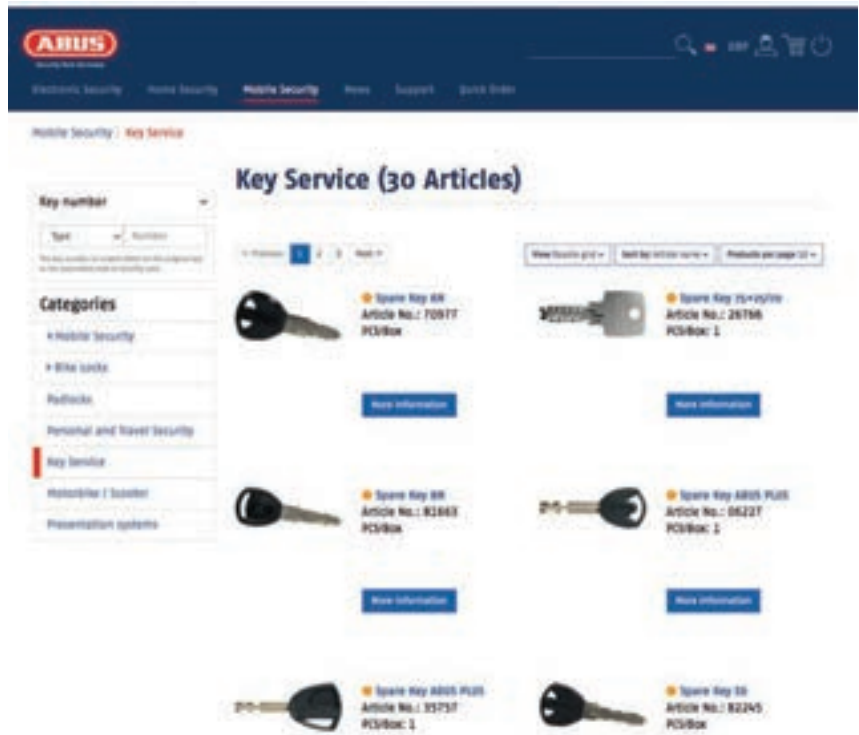

Whether you're looking for instructions for the Partner Portal or instructions for the products, you will find both in the service area under the heading "Downloads".

Product and milieu photos as well as logos and lifestyle images are also available for convenient download.

## 6 REASONS TO TAKE A COURSE WITH US

The current situation shows how important it is to offer different training formats in order to diversify. Online training as an indispensable supplement to face-to-face seminars has become an essential part of life now.

You can find an overview of our seminar offerings on our Academy homepage: [myagi.com/s/abusinternational](https://myagi.com/s/abusinternational)



### **MORE SALES FOR YOUR BUSINESS**

As much input as possible for the sale and professional consultation of security products - that is the concept and goal of ABUS training courses. This directly boosts your sales success and in turn directly brings higher sales.



### **FROM THE INDUSTRY, FOR THE INDUSTRY**

The trainers at the ABUS Academy have been in the industry for a long time and draw on a wide range of expertise, which is constantly adapted to current conditions and goes far beyond the actual product training.



### **COMPREHENSIVE ACADEMY OFFERINGS**

The offers of the ABUS Academy range from product training to sales training, personal development and management training, or entrepreneurial coaching. Continuing education all in one place.



### **LEARNING IN A RELAXED ATMOSPHERE**

It's not just expertise that's important to us. The transfer of knowledge is also enriched with many practical examples, interesting group work and other didactic measures, to make learning at ABUS enjoyable. In this way, we also ensure the transfer of learning in the long term.



### **SUPPLEMENTS AND ENSURING LEARNING SUCCESS IN THE LONG TERM**

Even after our seminars are over, we don't leave you on your own. Through the webinars we offer, you can find further content or discuss the experiences you gained from the seminar and customer practice with your advisor again.



### **DIGITAL COMBINED WITH PRESENCE**

Webinars, online clips combined with classroom training. Consolidate what you have learned digitally afterwards or use the offer to prepare for your seminar. Independent of deadlines, always up to date in terms of product technology.



# MYAGI – DIGITAL TRAINING PLATFORM

Experience the training platform for the bicycle industry live - important insider knowledge first hand.  
With just one login, you get access to content from multiple manufacturers.

## FIRST-HAND INDUSTRY KNOWLEDGE IN THREE MINUTES

No matter when, how or where you want to deepen your knowledge - Myagi is always there for you, everywhere.

### CONTENT

- Accessible 24/7, any time, anywhere (PC, smartphone, tablet)
- Knowledge database so info is available at any time
- Can also be used for internal training purposes
- Entertaining learning: Courses are divided into three-minute lessons
- Sales tips for various products on one platform

Simply register, take a look and get started:  
[myagi.com/s/abusinternational](https://myagi.com/s/abusinternational)



### DURATION

Lesson duration approx. 3 minutes A course consists of several lessons.



### COSTS

Free



### DATES/PLACE

Dates and registration at  
[myagi.com/s/abusinternational](https://myagi.com/s/abusinternational)



# ABUS - MADE IN GERMANY

When August Bremicker and his sons founded ABUS in 1924, they had a lot of experience with engineering and craftsmanship – as well as a very clear vision: They wanted to create products that protected human life and property. It was a far-sighted corporate guideline – paired with an expectation for quality right from the start. It was the start of a continuous success story. The ABUS brand became a synonym for security world-wide.



## HIGH-QUALITY MATERIALS

To be able to offer consistently high quality and security against every type of brutal and intelligent attack technique, we use the highest-quality materials at every price level. Complex hardening processes guarantee the best resistance in our materials. Our internal quality management check all materials before and during the production process to ensure every product has the high quality you demand.

## THE KEY TO SUCCESS

At ABUS, we design and build the tools and machines used in the production of our products in-house. That bundles knowhow, guarantees jobs, and strengthens identification. Our own engineering and toolmaking department concentrates exclusively on the development of bicycle and motorcycle locks. This ensures that we meet the tough requirements you place on your bicycle or motorcycle lock every day.

## ENSURING CONSISTENCY

In our own ABUS test laboratory, we routinely carry out tests and attacks on our products to ensure our products offer consistently high quality.

Among others we make sure our locks are resistant to:

- Ice spray attacks and freezing conditions at  $-40^{\circ}\text{C}$
- Twisting, pulling, hammering and sawing attacks with help of our manual or mechanical tests
- Rust by simulating highly corrosive weather conditions

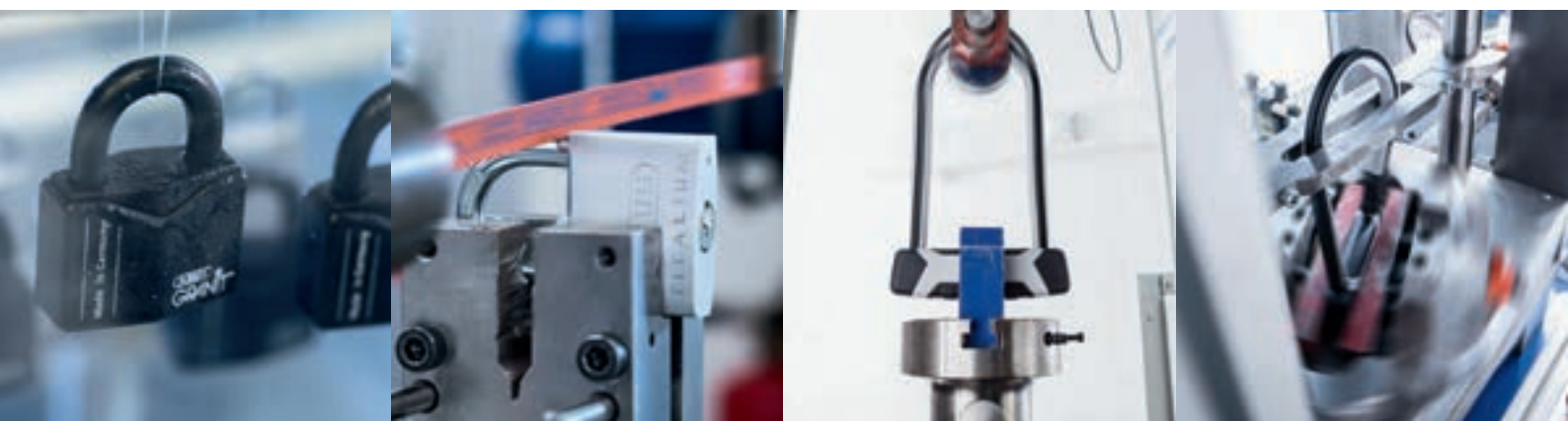

# APPROVALS

ABUS locks are tested and approved by independent, neutral testing institutions in a number of European countries. As every test lab use different tools, techniques and machines to test both security and quality we are very proud of the high number of different approvals given to ABUS products. If a lock can pass the varying test requirements in many different countries you can be sure it is of the highest possible quality and security.

The following seals of approval confirm the outstanding security of ABUS cycle locks:



Svenska Stöldsnyddsföreningen  
Stockholm, Sweden



Norges Forsikringsforbund  
Oslo, Norway



Dansk Varefakta Naevn  
Copenhagen, Danmark



Finanssiala  
Helsinki, Finland



ART (ANWB, RAI, Theft Insurers)  
Helmond, The Netherlands



Sold Secure  
Northants, Great Britain



Test Seal OSIMZ  
Moscow, Russia



Test Seal VdS  
Cologne, Germany



ABUS Seal for Ice Spray Test  
Volmarstein, Germany



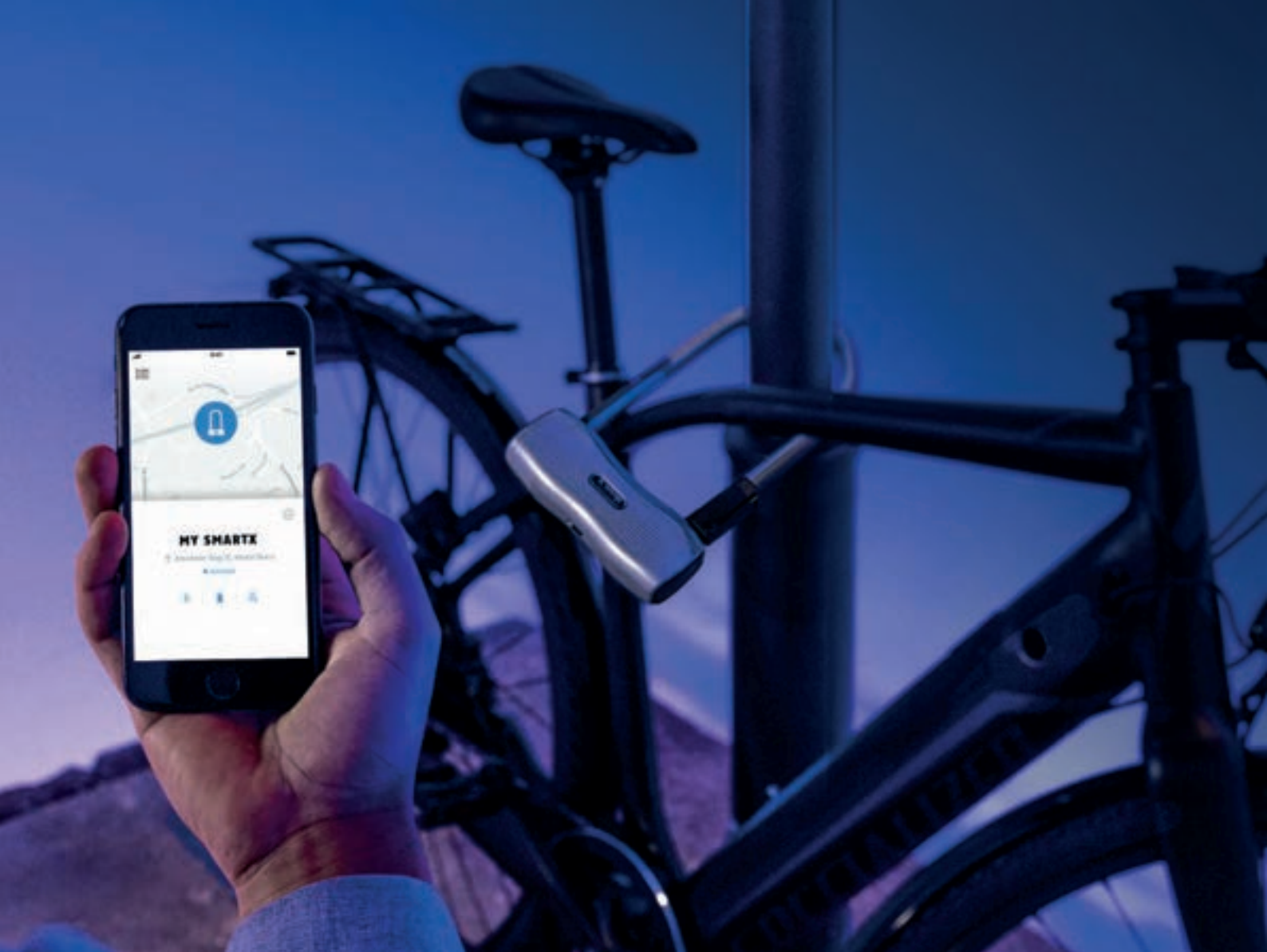

## KEYLESS IS MORE

Don't live in the past. With SmartX™ locks, the smartphone becomes the key. Open and close via Bluetooth. Convenience like never before thanks to the latest keyless technology - with the maximum security you're used to.



### BLUETOOTH®

The lock receives encrypted signals from the smartphone - just as secure as the lock itself and more individualized than any key.

### KEYLESS

Your smartphone becomes the key: A keycard connects the corresponding ABUS app (iOS or Android) to the lock.



## OUR ASSORTMENT

Made in Germany



### SMARTX APP

Each Bordo 6500 SmartX™ can be used by multiple persons. The decision whether a person is granted time limited or permanent access is up to the administrator. For the cargo bicycle behind the house or the children's trailer at the nursery – this is how families lock in the twenty-first century!

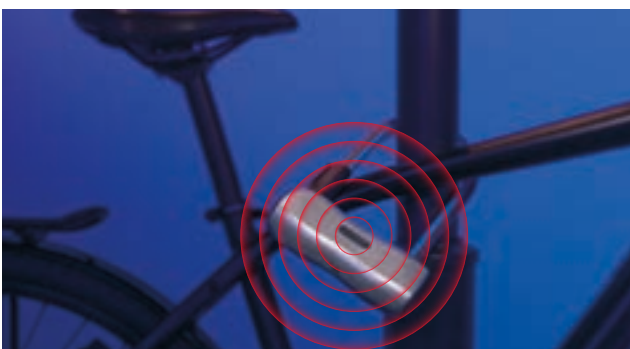

### ALARM

With the integrated alarm function, our SmartX™ products offer added security.

The 3D Position Detection detects slightest movements and triggers a deterrent alarm.

If slightly moved, the lock issues only a short warning sound. But if the sensors detect a theft attempt, the alarm sound increases its volume to a deafening 100 decibels.

### AT A GLANCE



Hands free: locking and unlocking via smartphone



Lock with 100 dB alarm function



Rechargeable battery (USB Type-C)

## U-SHACKLE LOCKS



**GRANIT™ EXTREME 59**



black

Page 14

**GRANIT XPLUS™ 540**



black

Page 18

**GRANIT™ PLUS 470**



black

Page 21

**440 ALARM**



red

Page 24

**FACILO 32**



black

Page 26

**770A SMARTX™**



black

Page 16

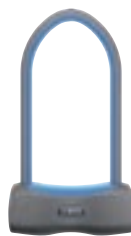

blue

Page 16

**GRANIT™ PLUS 640**



red

Page 20



black

Page 20

**ULTIMATE 420**



red

Page 22

**GRANIT™ 460**



black

Page 23

**ULTRA 410**



green

Page 25

**ULTRA 410 COMBO**



green

Page 25



black

Page 25

**402**





yellow

Page 27



### GRANIT™ Extreme 59

Originating from our motorcycle range, the Granit Extreme is the toughest ABUS U-lock available. The massive 16mm square shackle is practically impossible to cut with hand-tools. With a square interface anchoring the shackle to two independent power cells, every attacker needs to break the lock twice to take your bike. With over 1 million key codes intelligent picking attacks are equally futile. Need the ultimate two-wheeled security? You are in the right place.

Ref. No.	EAN	 mm	 mm	 mm	Weight g	Carrier	Box Qty
59/180HB245	58606 4	245	111	19	2600		1
59/180HB260	58607 1	260	111	19	2700		1
SH 59	23763 8				420		2



# GRANIT™ EXTREME 59



## SECURITY LEVEL



Security Level  
Motorbike

## FEATURES



XPlus™



SH 59

## TECHNOLOGY



## TEST SEALS





## TECHNICAL DATA

- 16 mm hardened square shaft parabolic shackle
- Square shackle interface in lock body prevents levering
- Double-locked shackle
- All structural parts manufactured using proprietary, specially hardened steel alloys
- ABUS XPlus cylinder with over 1 million genuine key differs for exceptional protection against manipulation
- Two keys included, one with a LED light
- Manual cover to protect the keyhole from dirt and corrosion
- ABUS Code Card for additional and replacement keys



### 770A SmartX™

The U-shackle lock 770A SmartX from ABUS combines the highest security with smart technology. Enjoy the benefits of the innovative SmartX locking system and make your iOS- or Android smartphone your personal key. Combined with the proven 100 dB alarm, this lock offers the highest level of security for high-quality e-bikes and cargo bikes.

Ref. No.	EAN 4003318	 mm	 mm	 mm	Weight g	Carrier	Box Qty
770A/160HB230 blue SmartX	84520 8	230	108	17	2000		2
770A/160HB230 blue + USKF SmartX	84521 5	230	108	17	2150	USKF	2
770A/160HB230 black SmartX	82361 9	230	108	17	2000		2
770A/160HB300 black SmartX	82362 6	300	108	17	2200		2
770A/160HB230 black + USKF SmartX	82359 6	230	108	17	2150	USKF	2
770A/160HB300 black + USKF SmartX	82360 2	300	108	17	2350	USKF	2
SmartX RC	64000 1				20		1

# 770A SMARTX™

## VERSIONS



blue

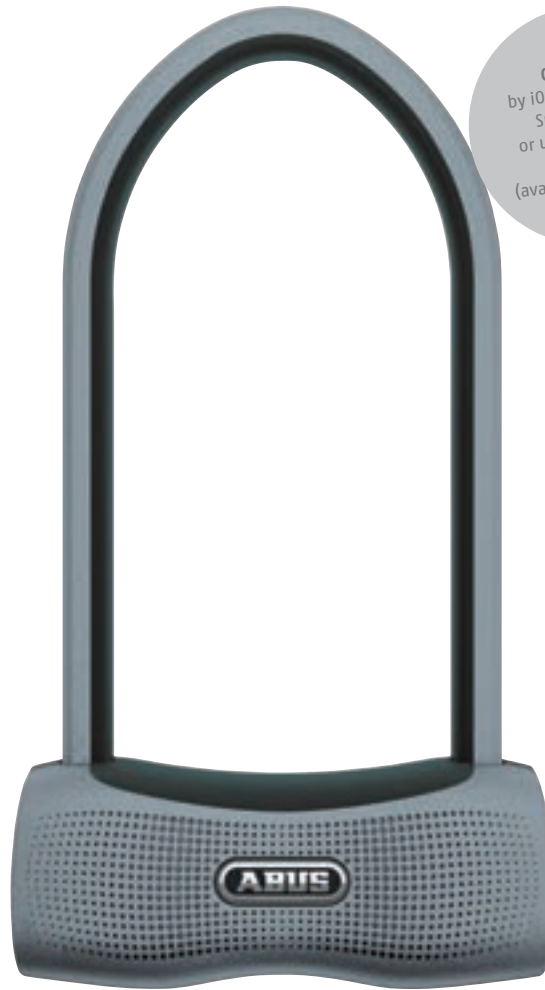

Controlled by iOS- and Android Smartphones or using the Smart Remote (available separately)

## SECURITY LEVEL



## FEATURES



SmartX RC



USB-C

## TECHNOLOGY



## TEST SEALS



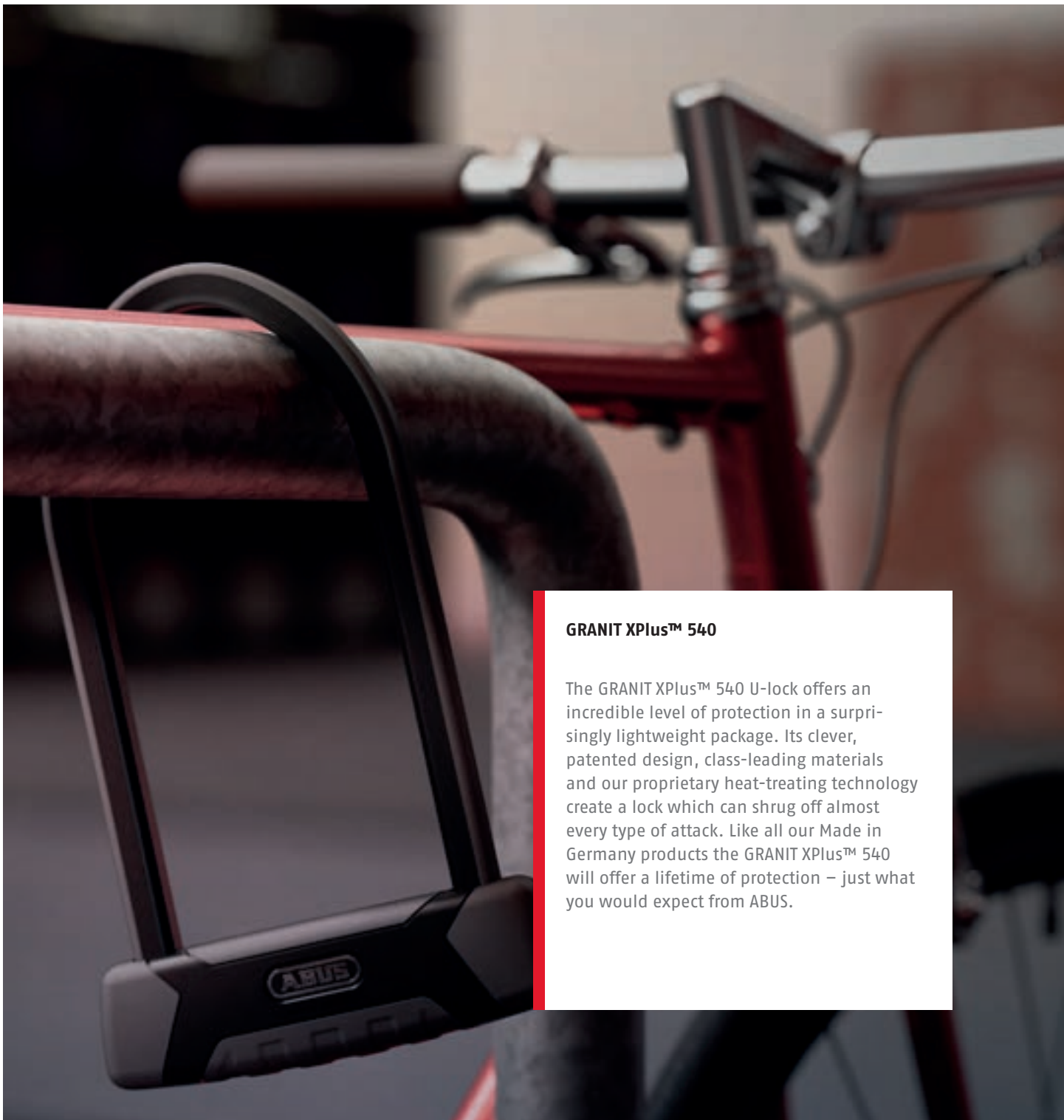

## TECHNICAL DATA

- 13 mm hardened square shaft parabolic shackle
- SmartX™ locking system with Bluetooth® – high-quality, keyless locking offers user-friendly operation
- Alarm function with at least 100 dB for 15 seconds followed by automatic reactivation
- 3D Position Detection – detects vibrations and the smallest movement in all three dimensions and triggers the alarm
- Smart alarm – the lock only emits a small warning beep in the event of minor and brief vibrations, e.g. if a football bounces nearby
- USB-C port
- App connection
- Location storage of the bike's last parking location
- ABUS power cell technology offers the highest level of protection against impacts and attempts to break open the lock
- The shackle, housing and locking mechanism are manufactured using proprietary, specially hardened steel alloys



### GRANIT XPlus™ 540

The GRANIT XPlus™ 540 U-lock offers an incredible level of protection in a surprisingly lightweight package. Its clever, patented design, class-leading materials and our proprietary heat-treating technology create a lock which can shrug off almost every type of attack. Like all our Made in Germany products the GRANIT XPlus™ 540 will offer a lifetime of protection – just what you would expect from ABUS.

Ref. No.	EAN 4003318	 mm	 mm	 mm	Weight g	Carrier	Box Qty
540/160HB230	11161 7	230	108	17	1500		6
540/160HB300	11179 2	300	108	17	1700		6
540/160HB230+USH540	11186 0	230	108	17	1650	USH 540	5
540/160HB300+USH540	11188 4	300	108	17	1850	USH 540	5
540/160HB230+ SH B	69076 1	230	108	17	1650	SH B	4
540/160HB300+ SH B	69075 4	300	108	17	1850	SH B	4

# GRANIT XPLUS™ 540



Fits in the universal SH B carrier

## SECURITY LEVEL



## FEATURES



XPlus™



USH 540



SH B

## TECHNOLOGY



## TEST SEALS



## TECHNICAL DATA

- 13 mm hardened square shaft parabolic shackle
- Square shackle interface in lock body prevents levering
- Double-locked shackle
- ABUS power cell technology offers the highest level of protection against impacts and attempts to break open the lock
- All structural parts manufactured using proprietary, specially hardened steel alloys
- ABUS XPlus cylinder for exceptional protection against manipulation
- Two keys included, one with a LED light
- Available keyed alike to most ABUS XPlus cylinder locks
- Automatic keyhole cover to protect against dirt and corrosion

1) 30330

# GRANIT™ PLUS 640

## SECURITY LEVEL



## FEATURES



Plus



TexKF



## VERSIONS



HB150 black



HB230 black

## TECHNICAL DATA

- Hardened 12 mm round shackle
- All structural parts manufactured using proprietary, specially hardened steel alloys
- Use of special lightweight alloys to achieve class-leading weight
- ABUS Plus cylinder including automatic cover for maximum protection against attempts at manipulation
- Available keyed alike to any ABUS Plus cylinder lock

## TECHNOLOGY



## TEST SEALS



1) Only for SE-version (Art.-No. 72509), 2) 31644

Ref. No.	EAN 4003318	mm	mm	mm	Weight g	Carrier	Box Qty
640/135HB150 red	39704 2	150	83	15	800		6
640/135HB150 black	39702 8	150	83	15	800		6
640/135HB230+TexKF black	39703 5	230	83	15	1060	TexKF	6

# GRANIT™ PLUS 470

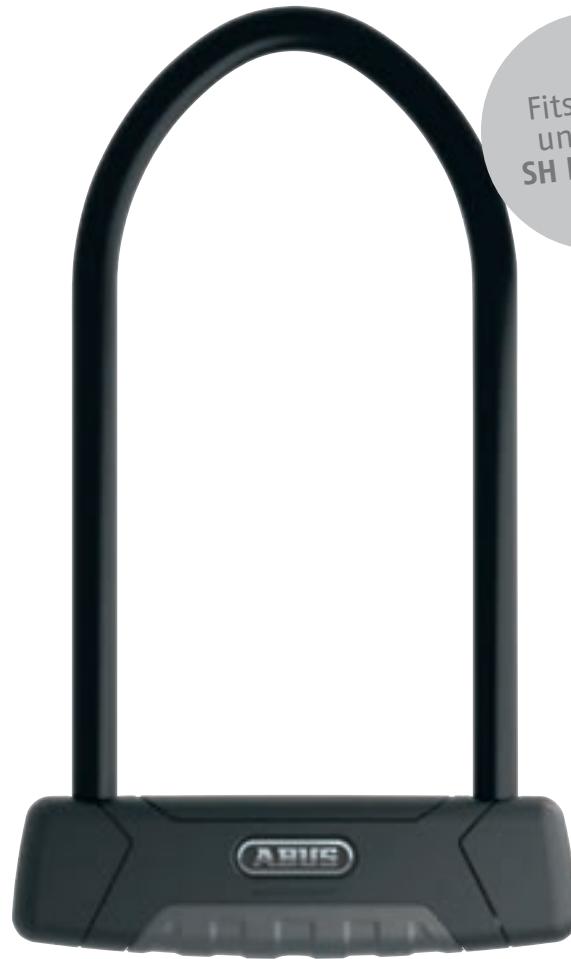

Fits in the universal SH B carrier

## SECURITY LEVEL



## FEATURES



Plus



USH 460/470



SH B

## TECHNICAL DATA

- Hardened 12 mm parabolic shackle
- ABUS Power Cell technology provides outstanding protection against attempts to remove the lock by hitting or pulling
- All structural parts manufactured using proprietary, specially hardened steel alloys
- Automatic cover to protect the keyhole from contamination and corrosion
- Available keyed alike to any ABUS Plus cylinder

## TECHNOLOGY



## TEST SEALS



1) 30328

Ref. No.	EAN 4003318	mm	mm	mm	Weight g	Carrier	Box Qty
470/150HB230+USH470	11249 2	230	109	14	1260	USH 470	6
470/150HB300+USH470	11251 5	300	109	14	1320	USH 470	5
470/150HB230+ SH B	69073 0	230	109	14	1290	SH B	4
470/150HB300+ SH B	69072 3	300	109	14	1350	SH B	4

# ULTIMATE 420

## SECURITY LEVEL



## FEATURES



USH



## VERSIONS



420/170HB230

## TECHNICAL DATA

- Hardened 13 mm round shackle
- All structural parts manufactured using proprietary, specially hardened steel alloys
- Ergonomic lock body cover enables optimum handling
- High-quality locking cylinder for high protection against manipulation

## TECHNOLOGY



## TEST SEALS



1) 33241

Ref. No.	EAN 4003318	mm	mm	mm	Weight g	Carrier	Box Qty
420/150HB140+USH Ultimate	81689 5	140	80	17	900	USH	6
420/170HB230+USH Ultimate	39631 1	230	100	17	1100	USH	6
420/150HB140+USH+10/120 Ultimate	81969 8	140	80	17	1240	USH	6
420/170HB230+USH+10/120 Ultimate	39633 5	230	100	17	1440	USH	6



# GRANIT™ 460



Fits in the universal SH B carrier

## SECURITY LEVEL



## FEATURES



USH 460/470



SH B

## TECHNICAL DATA

- Hardened 12 mm parabolic shackle
- All structural parts manufactured using proprietary, specially hardened steel alloys
- ABUS Extra Class cylinder with coded reversible key

## TECHNOLOGY



## TEST SEALS



Ref. No.	EAN 4003318	mm	mm	mm	Weight g	Carrier	Box Qty
460/150HB230+USH460	11253 9	230	109	14	1000	USH 460	6
460/150HB300+USH460	11255 3	300	109	14	1250	USH 460	6
460/150HB230+ SH B	69070 9	230	109	14	1050	SH B	6
460/150HB300+ SH B	69071 6	300	109	14	1300	SH B	6

# 440 ALARM

## SECURITY LEVEL



## FEATURES



USH



## TECHNICAL DATA

- Hardened 12 mm round shackle
- All structural parts manufactured using proprietary, specially hardened steel alloys
- Ergonomic lock body cover enables optimum handling
- High-quality locking cylinder for high protection against manipulation,
- 100 dB alarm function
- 3-D Position Detection – detects impacts and movements
- CR2 batteries included

## TECHNOLOGY



## TEST SEALS



Ref. No.	EAN 4003318	mm	mm	mm	Weight g	Carrier	Box Qty
440A/150HB160 USH Alarm	82605 4	160	85	14	1100	USH	4
440A/170HB230 USH Alarm	82606 1	230	108	14	1500	USH	4

## ULTRA 410

### SECURITY LEVEL



### FEATURES



SH34

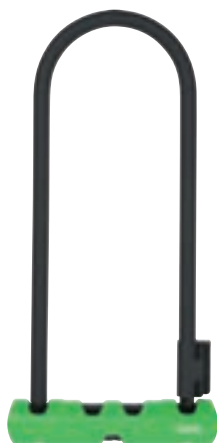

### TECHNICAL DATA

- Hardened 12 mm round shackle
- All structural parts manufactured using proprietary, specially hardened steel alloys
- Ergonomic lock body cover enables optimum handling
- High-quality locking cylinder for a high level of protection against manipulation

### TECHNOLOGY



### TEST SEALS



Ref. No.	EAN 4003318	mm	mm	mm	Weight g	Carrier	Box Qty
410/150HB140 SH34	34594 4	140	80	14	755	SH34	6
410/150HB140 SH34 + Cobra 10/120	34596 8	140	80	14	755 + 340	SH34	6
410/150HB180 SH34 + Cobra 10/120	34597 5	180	80	14	835 + 340	SH34	6
410/170HB230 GN SH34 Ultra	34591 3	230	110	14	1000	SH34	6
410/170HB230 GN SH34 Ultra + Cobra 10/120	34590 6	230	110	14	1000 + 340	SH34	6

## ULTRA 410 COMBO

### SECURITY LEVEL



### FEATURES



SH34



black



### TECHNICAL DATA

- 12 mm, hardened steel round shackle
- All structural parts manufactured using proprietary, specially hardened steel alloys
- Ergonomic lock body cover enables optimum handling
- Two component moulded digits guarantee life-long visibility
- Individually settable code

### TECHNOLOGY



### TEST SEALS



Ref. No.	EAN 4003318	mm	mm	mm	Weight g	Carrier	Box Qty
410C/170HB230 GN SH34 Ultra Combo	86740 8	230	110	14	1150	SH34	1
410C/170HB230 BK SH34 Ultra Combo	87787 2	230	110	14	1150	SH34	1

# FACILO 32

## SECURITY LEVEL



## FEATURES



USH 32



## VERSIONS



32/150HB230+  
USH32+10/140

## TECHNICAL DATA

- Hardened 12 mm round shackle
- ABUS top-quality locking cylinder
- Also available with 10 mm high-quality loop cable
- PVC casing to protect paintwork

## TECHNOLOGY



## TEST SEALS



Ref. No.	EAN 4003318	mm	mm	mm	Weight g	Carrier	Box Qty
32/150HB230+USH32	37492 0	230	109	15	950	USH 32	6
32/150HB230+USH32 + Cobra 10/140	62874 0	230	109	15	1440 + 390	USH 32	6
32/150HB300+USH32	37887 4	300	109	15	1160	USH 32	6



### SECURITY LEVEL



### FEATURES



SH34

### TECHNICAL DATA



- 11 mm, hardened steel round shackle
- Double-locking mechanism securing the shackle in the lock body
- The shackle, the body and the load-bearing parts of the locking mechanism are manufactured using specially hardened steel
- Special, modern design of the lock body casing allows for optimum handling
- High-quality locking cylinder for protection against manipulation, e.g., picking
- Four keys included with the lock

### TECHNOLOGY



### TEST SEALS



Ref. No.	EAN 4003318	 mm	 mm	 mm	Weight g	Carrier	Box Qty
402/150HB160 YE SH34 Mini	86741 5	160	90	11	790	SH34	6
402/170HB230 YE SH34	86742 2	230	110	11	890	SH34	6

**FOLDING LOCKS**



**BORDO  
6500A SMARTX™**



6500A/110  
black  
Page 32

**BORDO GRANIT™  
6500KA**



6500KA/90  
black  
Page 34

**BORDO GRANIT XPLUS™  
6500**



6500/110  
black  
Page 36

**BORDO GRANIT™  
6500K**



6500K/90  
black  
Page 37

**BORDO™  
6000KA**



6000KA/90  
black  
Page 38



6000KA/120  
black  
Page 38

**BORDO™  
6000K**



6000K/90  
black  
Page 39



6000K/120  
black  
Page 39

**BORDO™  
6000PZ**



black  
Page 40

**BORDO™  
6000C**



black  
Page 42

**BORDO™  
6000C LED**



black  
Page 43

**UGRIP BORDO™  
5700K**



black  
Page 44



lime  
Page 44



blue  
Page 44



red  
Page 44

**UGRIP BORDO™  
5700C**



red  
Page 45



lime  
Page 45

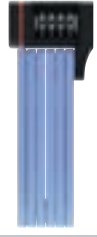

blue  
Page 45



black  
Page 45

**BORDO™  
LITE 6055K**



Movistar Team

Page 46



black

Page 46



red

Page 46

**BORDO™  
LITE 6055C**



black

Page 47



red

Page 47



Movistar Team

Page 47



pink SYMBOLS

Page 47



blue SYMBOLS

Page 47





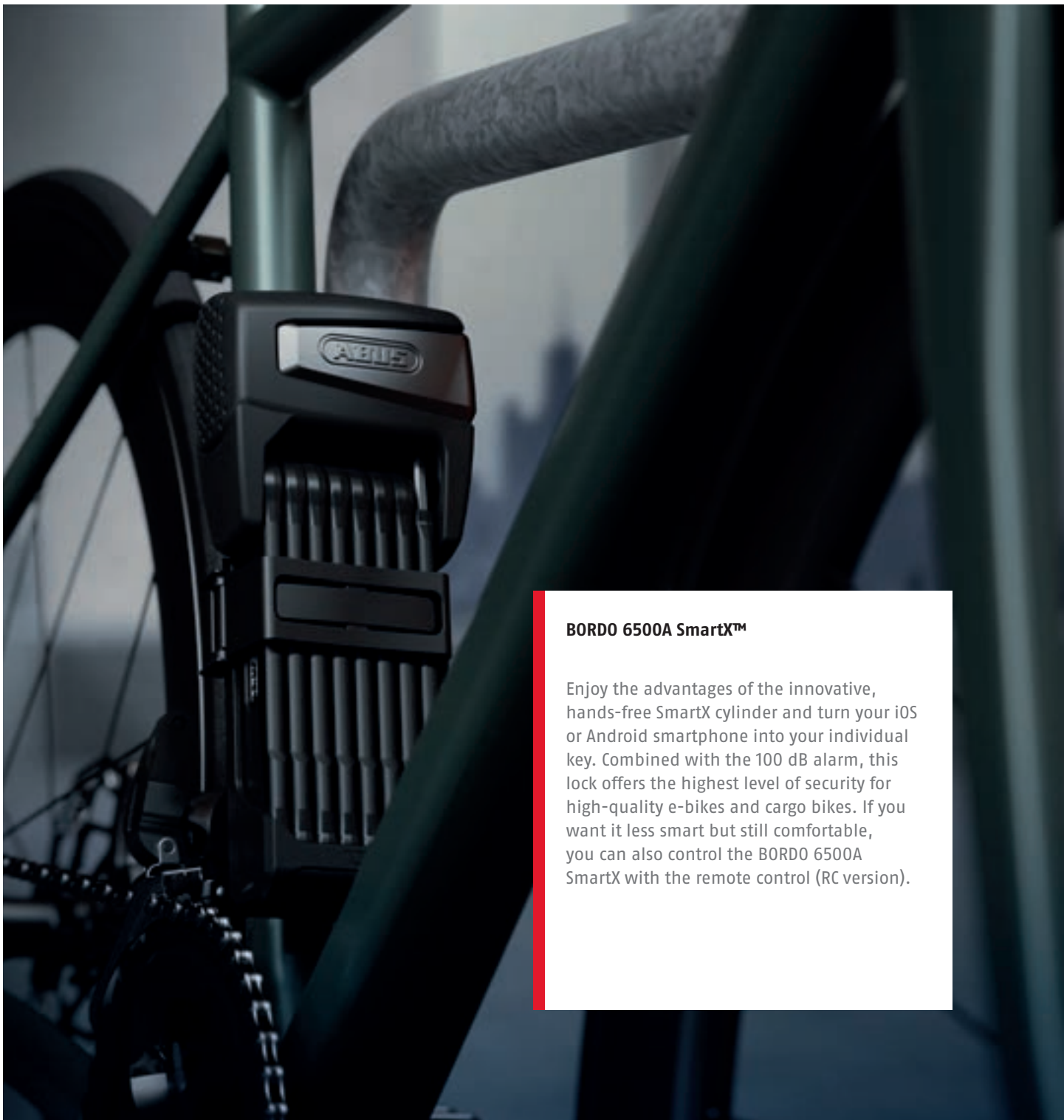

### BORDO 6500A SmartX™

Enjoy the advantages of the innovative, hands-free SmartX cylinder and turn your iOS or Android smartphone into your individual key. Combined with the 100 dB alarm, this lock offers the highest level of security for high-quality e-bikes and cargo bikes. If you want it less smart but still comfortable, you can also control the BORDO 6500A SmartX with the remote control (RC version).

Ref. No.	EAN 4003318	 cm	Weight g	Carrier	Box Qty
6500A/110 BK SH SmartX	61495 8	110	2300	SH	3
6500A/110 BK SH RC SmartX	61497 2	110	2320	SH	3
Bracket SH BORDO 6500A SmartX	63488 8		148	replacement bracket	1
SmartX RC	64000 1		20		1

# BORDO 6500A SMARTX™



Controlled by iOS- and Android Smartphones or using the Smart Remote (available separately)

## SECURITY LEVEL



## FEATURES



SmartX RC



Bracket SH BORDO 6500A SmartX

Folding locks

## TECHNOLOGY



## TEST SEALS



## TECHNICAL DATA

- 5.5 mm bars with extra-soft two-component casing to prevent damage to paintwork
- SmartX™ locking system with Bluetooth – high-quality, keyless locking offers user-friendly operation
- Alarm function with at least 100 dB for 15 seconds followed by automatic reactivation
- 3D Position Detection – detects vibrations and the smallest movement in all three dimensions and triggers the alarm
- Smart alarm – the lock only emits a small warning beep in the event of minor and brief vibrations, e.g. if a football bounces against the bike
- USB-C port
- App connection
- Location storage of the bike's last parking location
- LED light shows battery- and charging-status
- Also available with remote control (RC version)
- Incl. bracket (SH)



### BORDO GRANIT™ 6500KA

We combine the proven 3D sensitive alarm system with an advanced security category. This makes the toughest ABUS folding lock on the market now even more robust. Thanks to the intelligent ABUS alarm system, your neighbors will no longer be exasperated by constant false alarms. Only when an attack is suspected does the full alarm activate - accidental bumps and movements, on the other hand, only trigger a brief, 5-second warning.

Ref. No.	EAN 4003318	 cm	Weight g	Carrier	Box Qty
6500KA/90 BK SH	69052 5	90	2020	SH	1
Bracket SH 6500K/90	69051 8		195	replacement bracket	3

# BORDO GRANIT™ 6500KA

★  
NEW



## SECURITY LEVEL



## FEATURES



XPlus™



Bracket SH 6500K/90

Folding locks

## TECHNOLOGY



## TEST SEALS



## TECHNICAL DATA

- 5.5 mm bars with extra-soft casing to prevent damage to paintwork
- All structural parts manufactured using proprietary, specially hardened steel alloys
- Alarm function with at least 100 dB for 15 seconds followed by automatic reactivation
- 3-D position alarm detection - detects impacts and movement in all dimensions
- Smart alarm – the lock only emits a small warning beep in the event of minor and brief vibrations, e.g. if a football bounces against the bike
- ABUS Link Protection Shield for a high level of protection against link attack
- Incl. bracket (SH)
- Available keyed alike to most ABUS XPlus cylinder locks

1) applied for

# BORDO GRANIT XPLUS™ 6500

## SECURITY LEVEL



## FEATURES



XPlus™



Bracket SH 6500/110



## TECHNICAL DATA

- 5.5 mm bars with extra-soft two-component casing to prevent damage to paintwork
- Colour-coordinated Soft-Touch silicone cover for the lock body
- ABUS Link Protection Shield for a high level of protection against hinge sawing
- The bars, lock body and all structural parts manufactured using proprietary, specially hardened steel alloys
- ABUS XPlus cylinder for extremely high protection against manipulation, e.g. picking
- Available keyed alike to most ABUS XPlus cylinder locks

## TECHNOLOGY



## TEST SEALS



1) 20768

Ref. No.	EAN 4003318	 cm	Weight g	Carrier	Box Qty
6500/110 BK SH	78067 7	110	2332	SH	4
Bracket SH 6500/110	61556 6		172	replacement bracket	3

# BORDO GRANIT™ 6500K

NEW

## VERSIONS



Twinset



## SECURITY LEVEL



## FEATURES



XPlus™



Bracket SH 6500K/90

Folding locks

## TECHNICAL DATA

- 5.5 mm bars with extra-soft casing to protect paintwork
- All structural parts manufactured using proprietary, specially hardened steel alloys
- ABUS Link Protection Shield for a high level of protection against link attack
- ABUS XPlus cylinder for extremely high protection against manipulation
- Available keyed alike to most ABUS XPlus cylinder locks

## TECHNOLOGY



## TEST SEALS



1) applied for

Ref. No.	EAN 4003318	cm	Weight g	Carrier	Box Qty
6500K/90 BK SH	61498 9	90	1670	SH	4
6500K/90 BK SH Twinset	61499 6	90	1670 per lock	SH	2
Bracket SH 6500K/90	69051 8		195	replacement bracket	3

# BORDO™ 6000KA

★  
NEW

## SECURITY LEVEL



## FEATURES



XPlus™



Bracket SH 6000/90



Bracket SH 6000/120



## VERSIONS



6000KA/120

## TECHNICAL DATA

- 5mm bars with extra-soft casing to protect paintwork
- All structural parts manufactured using proprietary, specially hardened steel alloys
- 100 dB alarm function
- 3-D position alarm detection – detects impacts and movements
- Smart alarm – warning sound for unintended movement
- Acoustic signals provide information on battery level and activity status
- Bars are linked with special attack-resistant rivets
- ABUS XPlus cylinder for exceptional protection against manipulation
- Incl. SH bracket
- Available keyed alike to most ABUS XPlus cylinder locks

## TECHNOLOGY



## TEST SEALS



1) applied for

Ref. No.	EAN 4003318	cm	Weight g	Carrier	Box Qty
6000KA/90 BK SH	61500 9	90	1450	SH	4
6000KA/120 BK SH	62090 4	120	1700	SH	4
Bracket SH 6000/90	61543 6		115	replacement bracket	3
Bracket SH 6000/120	61564 1		132	replacement bracket	3



# BORDO™ 6000K

NEW

## VERSIONS



6000K/120



## SECURITY LEVEL



## FEATURES



XPlus™



Bracket SH 6000/90



Bracket SH SF 6000/90



Bracket SH 6000/120

## TECHNICAL DATA

- 5mm bars with extra-soft casing to protect paintwork
- All structural parts manufactured using proprietary, specially hardened steel alloys
- Bars are linked with special attack-resistant rivets
- ABUS XPlus cylinder for high protection against manipulation
- Available keyed alike to most ABUS XPlus cylinder locks

## TECHNOLOGY



## TEST SEALS



1) applied for

Ref. No.	EAN 4003318	cm	Weight g	Carrier	Box Qty
6000K/90 BK SH	62094 2	90	1207	SH	4
6000K/90 BK SH Twinset	62095 9	90	1207 per lock	SH	4
6000K/90 BK SH SF	67865 3	90	1207	SH SF	4
6000K/120 BK SH	62091 1	120	1546	SH	4
6000K/120 BK SH Twinset	67465 5	120	1546 per lock	SH	2
Bracket SH 6000/90	61543 6		115	replacement bracket	3
Bracket SH SF 6000/90	67866 0		244	replacement bracket	3
Bracket SH 6000/120	61564 1		132	replacement bracket	3

Folding locks

# BORDO™ 6000PZ

★  
NEW

## SECURITY LEVEL



## FEATURES



Bracket SH 6000/90



## TECHNICAL DATA

- 5 mm thick rods, with extra soft 2-component coating to protect against paint damage
- The bars and the housing are made of specially hardened steel
- Bars are linked with special attack-resistant rivets
- Manual cover to protect against dirt
- Suitable for various half cylinders

## TEST SEALS



Ref. No.	EAN 4003318	 cm	Weight g	Carrier	Box Qty
6000PZ/90 BK SH + EC 550	40663 8	90	1464	SH	3
6000PZ/90 BK SH without Cylinder	61478 1	90	1464	SH	3

## **BORDO 6000PZ: THE BIKE LOCK FOR THE FRONT DOOR KEY**

Like no other company, ABUS stands for security - at home or on the road.  
Now ABUS combines these two worlds in one product and presents a true innovation with the BORDO 6000PZ:

The proven folding lock is now available with a profile cylinder:  
The first bike lock that can be opened with the front door key.

A key for everything that needs to be secure.



### **MANY APPLICATIONS - 1 KEY.**

It's quite simple:

The customer wants to have their Bordo keyed alike with their front door key?  
This is now easily possible.

1. Either the BORDO is made to match the existing front door cylinder or the front door cylinder is adapted to the BORDO.
2. Operate everything with one key!

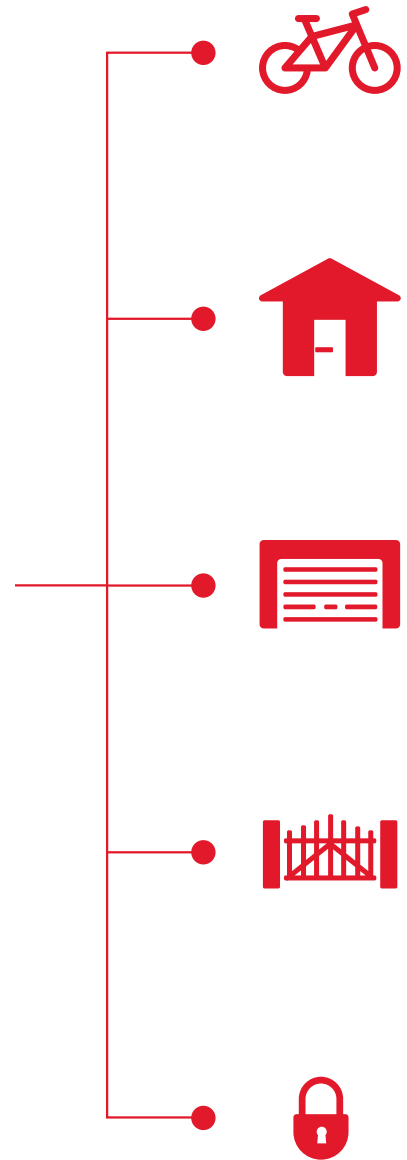

# BORDO™ 6000C

★  
NEW

## SECURITY LEVEL



## FEATURES



Bracket SH 6000/90



Bracket SH SF 6000/90

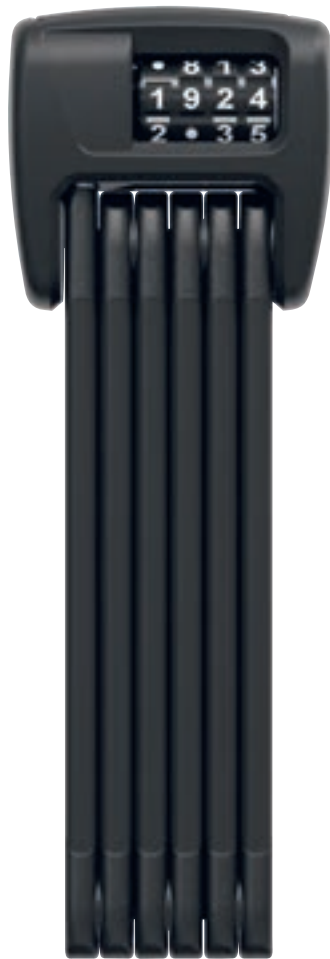

## TECHNICAL DATA

- 5mm bars with extra-soft casing to protect paintwork
- All structural parts manufactured using proprietary, specially hardened steel alloys
- Bars are linked with special attack-resistant rivets
- Two-component digit cylinder ensures long-lasting legibility
- Individually configurable code
- Incl. SH bracket

## TECHNOLOGY



## TEST SEALS



Ref. No.	EAN 4003318	 cm	Weight g	Carrier	Box Qty
6000C/90 BK SH	67599 7	90	1050	SH	4
6000C/90 BK SH SF	69069 3	90	1050	SH SF	4
Bracket SH 6000/90	61543 6		115	replacement bracket	3
Bracket SH SF 6000/90	67866 0		244	replacement bracket	3

# BORDO™ 6000C LED

NEW

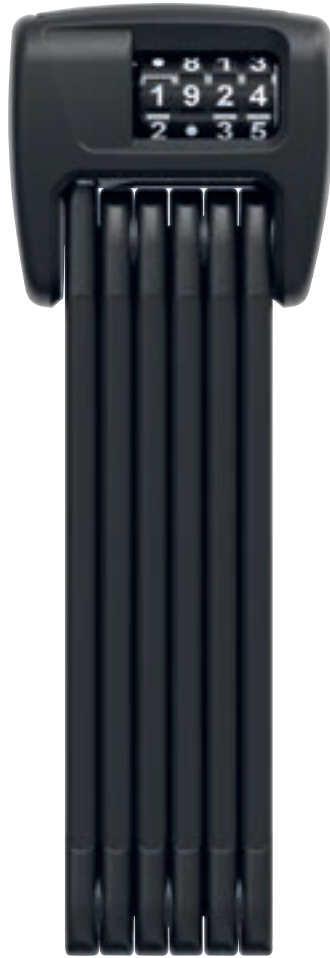

## SECURITY LEVEL



## FEATURES



LED



Bracket SH 6000/90

Folding locks

## TECHNICAL DATA

- 5mm bars with extra-soft casing to protect paintwork
- All structural parts manufactured using proprietary, specially hardened steel alloys
- Bars are linked with special attack-resistant rivets
- Integrated LED light for the illumination of the locking cylinder
- One CR1220 battery to power the LED light is included
- Two-component digit cylinder ensures long-lasting legibility
- Individually configurable code

## TECHNOLOGY



## TEST SEALS



Ref. No.	EAN 4003318	 cm	Weight g	Carrier	Box Qty
6000C/90 LED BK SH	69057 0	90	1050	SH	4
Bracket SH 6000/90	61543 6		115	replacement bracket	3

# UGRIP BORDO™ 5700K

## SECURITY LEVEL



## FEATURES



Bracket SH 5700/80



Bracket SH 5700K/100



## VERSIONS



lime



blue



red

## TECHNICAL DATA

- 5 mm steel bars
- Colour-matching lock body (only "core" colours)
- Bars are linked with special attack-resistant rivets
- High-quality automatic cylinder
- The "convenient transport mode" (CTM) enables super-fast bike lock-up (only 5700/100)

## TECHNOLOGY



## TEST SEALS



Ref. No.	EAN 4003318	cm 	Weight g	Carrier	Box Qty
5700K/80 black SH	84425 6	80	830	SH	6
5700K/80 lime SH	84427 0	80	830	SH	6
5700K/80 blue SH	84426 3	80	830	SH	6
5700K/80 red SH	84428 7	80	830	SH	6
5700K/100 black SH	86743 9	100	1050	SH	6
5700K/100 lime SH	86745 3	100	1050	SH	6
5700K/100 blue SH	86744 6	100	1050	SH	6
5700K/100 red SH	86746 0	100	1050	SH	6
Bracket SH 5700/80	61566 5		122	replacement bracket	3
Bracket SH 5700K/100	61571 9		122	replacement bracket	3

# UGRIP BORDO™ 5700C

## VERSIONS



lime



blue



black

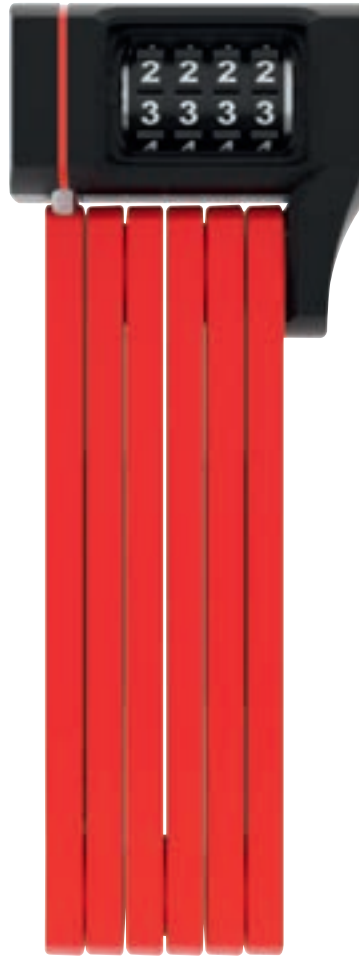

## SECURITY LEVEL



## FEATURES



Bracket SH 5700/80

Folding locks

## TECHNICAL DATA

- 5 mm steel bars
- Bars are linked with special attack-resistant rivets
- Two component moulded digits guarantee life-long visibility
- Individually settable code

## TECHNOLOGY



## TEST SEALS



Ref. No.	EAN 4003318	 cm	Weight g	Carrier	Box Qty
5700C/80 black SH	87791 9	80	830	SH	6
5700C/80 blue SH	87792 6	80	830	SH	6
5700C/80 lime SH	87793 3	80	830	SH	6
5700C/80 red SH	87794 0	80	830	SH	6
Bracket SH 5700/80	61566 5		122	replacement bracket	3

# BORDO™ LITE 6055K

## SECURITY LEVEL



## FEATURES



Bracket SH 6055



Bracket SR 6055



## VERSIONS



red



black

## TECHNICAL DATA

- Special steel design, with colour-coordinated plastic casing to prevent damage to paintwork
- The bars and housing are manufactured using particularly lightweight materials and steel alloys
- Bars are linked with special attack-resistant rivets
- High-quality automatic cylinder
- The BORDO™ Lite Mini is small enough to slip into the pocket of any cycling jersey

## TECHNOLOGY



## TEST SEALS



Ref. No.	EAN 4003318	 cm	Weight g	Carrier	Box Qty
6055/60 black	78060 8	60	400		6
6055K/60 black SH	62102 4	60	500	SH	6
6055K/60 black SR	62103 1	60	500	SR	4
6055/60 red	78061 5	60	400		6
6055/60 MOVISTAR TEAM	78062 2	60	400		6
6055K/85 black SH	78063 9	85	550	SH	6
6055K/85 black SR	62104 8	85	550	SR	6
6055K/85 red SH	78064 6	85	550	SH	6
Bracket SH 6055	61572 6		60	replacement bracket	3
Bracket SR 6055 Selle Royal	63151 1		64	replacement bracket	1



# BORDO™ LITE 6055C

## VERSIONS



red



Movistar



pink SYMBOLS



blue SYMBOLS



## SECURITY LEVEL



## FEATURES



Bracket SH 6055



Bracket SR 6055

Folding locks

## TECHNICAL DATA

- Special steel design, with colour-coordinated plastic casing to prevent damage to paintwork
- The bars and housing are manufactured using particularly lightweight materials and steel alloys
- Bars are linked with special attack-resistant rivets
- Two-component number reels guarantee long-term readability of the digits
- Individually configurable code
- Perfect security-weight ratio
- Incl. bracket (SH or SH Selle Royal)

## TECHNOLOGY



## TEST SEALS



Ref. No.	EAN 4003318	cm	Weight g	Carrier	Box Qty
6055C/60 black	62105 5	60	460		6
6055C/60 black SH	62110 9	60	550	SH	6
6055C/60 black SR	62114 7	60	550	SR	6
6055C/60 red	62106 2	60	460		6
6055C/60 Movistar Team	62107 9	60	460		6
6055C/60 pink SYMBOLS	62108 6	60	460		6
6055C/60 blue SYMBOLS	62109 3	60	460		6
6055C/85 black SH	62111 6	85	708	SH	6
6055C/85 black SR	62113 0	85	708	SR	6
6055C/85 red SH	62112 3	85	708	SH	6
Bracket SH 6055	61572 6		60	replacement bracket	3
Bracket SR 6055 Selle Royal	63151 1		64	replacement bracket	1

**CHAIN LOCKS**



**GRANIT CITYCHAIN  
XPLUS™ 1060**



black

Page 52

**IVY CHAIN  
9210**



black

Page 54

**CITYCHAIN™  
1010**



black

Page 55

**STEEL-O-CHAIN™  
9809**



black

Page 56

**STEEL-O-CHAIN™  
9808**



black

Page 57

**IVEN CHAIN  
8210**



black

Page 58

**IVYTEX CHAIN  
7210 COLOR**



racing yellow

Page 59



sparkling orange

Page 59



crossing grey

Page 59



diving blue

Page 59

**IVYTEX CHAIN  
7210**



black

Page 59

**STEEL-O-CHAIN™  
8807K**



black

Page 60

**TRESOR  
1385**



black

Page 61



aqua

Page 61



coral

Page 61



brown

Page 61

**TRESOR  
1385 COLOR**



Neon blue

Page 62



black

Page 62



Neon green

Page 62



Neon orange

Page 62



Neon pink

Page 62



grey star

Page 62



blue mask

Page 62



grey lightning

Page 62



cherry heart

Page 62



**6210**  
black  
Page 63



**CATENA 6806K**  
black  
Page 65



aqua  
Page 65



coral  
Page 65



brown  
Page 65



**CATENA 6806K NEON**  
Neon pink  
Page 65



Neon green  
Page 65



Neon blue  
Page 65



Neon orange  
Page 65



**CATENA 6806K COLOR**  
cherry heart  
Page 66



grey star  
Page 66



blue mask  
Page 66



grey lightning  
Page 66



**CATENA 6806K REFLECTIVE**  
reflective  
Page 67



**6806K CLASSIC**  
black  
Page 68



**STEEL-O-CHAIN™ 5805K**  
black  
Page 69



blue  
Page 69



red  
Page 69



lime  
Page 69



pink  
Page 69

**STEEL-O-CHAIN™  
5805C**



black

Page 70



blue

Page 70



red

Page 70



lime

Page 70



pink

Page 70

**STEEL-O-CHAIN™  
4804K**



black

Page 71



blue

Page 71



red

Page 71



lime

Page 71



pink

Page 71

**STEEL-O-CHAIN™  
4804C SYMBOLS**



green

Page 72



blue

Page 72



pink

Page 72



red

Page 72

**STEEL-O-CHAIN™  
4804C**



black

Page 73



blue

Page 73



red

Page 73



lime

Page 73



pink

Page 73

**1500 WEB**



black

Page 74



lime

Page 74



orange

Page 74



red

Page 74



white

Page 74



pink

Page 74

**1200 WEB**



black

Page 75



lime

Page 75



orange

Page 75



red

Page 75



white

Page 75



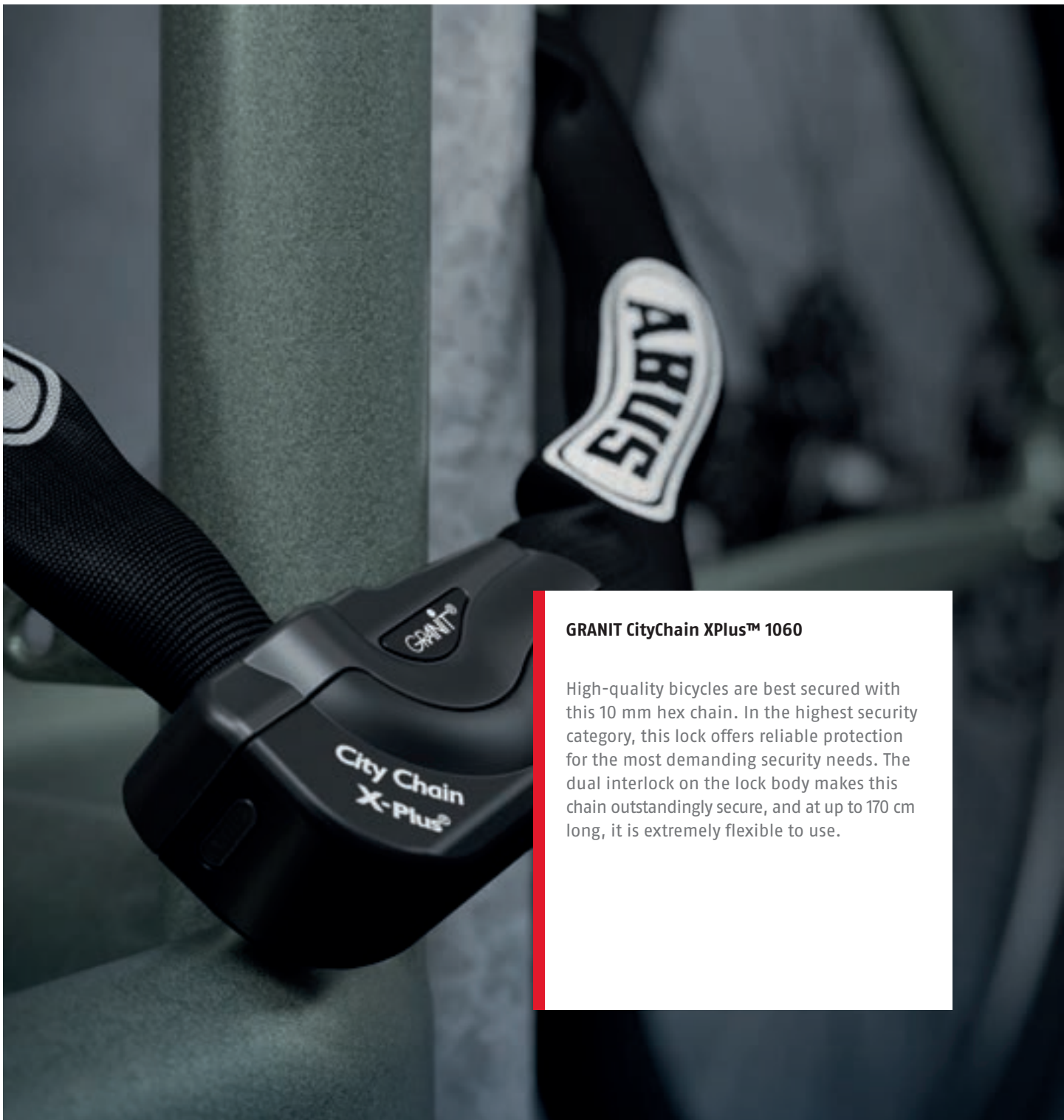

pink

Page 75



### GRANIT CityChain XPlus™ 1060

High-quality bicycles are best secured with this 10 mm hex chain. In the highest security category, this lock offers reliable protection for the most demanding security needs. The dual interlock on the lock body makes this chain outstandingly secure, and at up to 170 cm long, it is extremely flexible to use.

Ref. No.	EAN 4003318	 mm	 cm	Weight g	Carrier	Box Qty
1060/85 black	28678 0	10	85	2100		2
1060/110 black	28623 0	10	110	2650		2
1060/140 black	28624 7	10	140	3260		2
1060/170 black	28625 4	10	170	3750		2

# GRANIT CITYCHAIN XPLUS™ 1060



## SECURITY LEVEL



## FEATURES



XPlus™

Chain locks

## TECHNOLOGY



## TEST SEALS



## TECHNICAL DATA

- 10 mm hexagonal chain with webbing sleeve to protect paintwork
- ABUS Power Cell technology offers the highest level of protection against impacts and attempts to break open the lock
- ABUS Power Link technology enables the chain to be connected directly to the Power Cell
- Intermeshed lock body cover protects against brutal attack
- The chain, the lock body and supporting elements of the locking mechanism are made of proprietary, specially hardened steel alloys
- ABUS XPlus cylinder for the highest level of protection against manipulation
- Cover to protect the keyhole from contamination
- Available keyed alike to ABUS XPlus cylinder locks
- Two keys included, one with a LED light

1) 17218

# IVY CHAIN 9210

## SECURITY LEVEL



## FEATURES



## TECHNICAL DATA

- 10 mm square profile chain
- Durable, highly flexible IVY Tex synthetic fibre sleeve prevents damage to paintwork
- IVY Tex synthetic fibre slows down cutting attacks and repels dirt/moisture
- The chain, the lock body and supporting elements of the locking mechanism are made of proprietary, specially hardened steel alloys
- Ergonomically shaped lock body for easier handling and prevention of damage to paintwork
- Comes with a user-friendly reversible key

## TECHNOLOGY



## TEST SEALS



Ref. No.	EAN 4003318	⌀ mm	□ cm	Weight g	Carrier	Box Qty
9210/85 black	88691 1	10	85	2440		2
9210/110 black	88692 8	10	110	3000		2
9210/140 black	88693 5	10	140	3650		1
9210/170 black	88694 2	10	170	4400		1



# CITYCHAIN™ 1010



## SECURITY LEVEL



## FEATURES



Plus

Chain locks

## TECHNICAL DATA

- 9 mm hexagonal chain with webbing sleeve to protect paintwork
- The chain, the lock body and supporting elements of the locking mechanism are made of proprietary, specially hardened steel alloys
- ABUS Plus cylinder for high protection against manipulation
- Automatic cover for the keyhole against dirt and corrosion
- Available keyed alike to many other ABUS Plus cylinder locks

## TECHNOLOGY



## TEST SEALS



Ref. No.	EAN 4003318	⌀ mm	⓪⓪⓪⓪ cm	Weight g	Carrier	Box Qty
1010/85 black	33559 4	9	85	1850		2
1010/110 black	12042 8	9	110	2200		2
1010/140 black	12527 0	9	140	2650		2
1010/170 black	12528 7	9	170	3200		2

# STEEL- O- CHAIN™ 9809

## SECURITY LEVEL



## FEATURES



Plus



## TECHNICAL DATA

- 9 mm thick square chain with webbing sleeve to protect paintwork
- The chain, the lock body and supporting elements of the locking mechanism are made of proprietary, specially hardened steel alloys
- Automatic cover for the keyhole against dirt and corrosion
- ABUS Plus cylinder for high protection against manipulation
- Available keyed alike to many other ABUS Plus cylinder locks

## TECHNOLOGY



## TEST SEALS



1) 35210

Ref. No.	EAN 4003318	mm	cm	Weight g	Carrier	Box Qty
9809/85 black	78079 0	9	85	2100		2
9809/110 black	78080 6	9	110	2600		2
9809/140 black	78081 3	9	140	3100		2
9809/170 black	78082 0	9	170	3700		2

# STEEL-O-CHAIN™ 9808



## SECURITY LEVEL



## FEATURES



Plus

Chain locks

## TECHNICAL DATA

- 8 mm thick square chain with webbing sleeve to protect paintwork
- The chain, the lock body and supporting elements of the locking mechanism are made of proprietary, specially hardened steel alloys
- Automatic keyhole cover to prevent corrosion and the ingress of dirt
- ABUS Plus cylinder for high protection against manipulation
- Available keyed alike to many other ABUS Plus cylinder locks

## TECHNOLOGY



## TEST SEALS



1) 33324

Ref. No.	EAN 4003318	⌀ mm	□□□□ cm	Weight g	Carrier	Box Qty
9808/85 black	78075 2	8	85	1750		2
9808/110 black	78076 9	8	110	2550		2
9808/140 black	78077 6	8	140	2800		2

# IVEN CHAIN 8210

## SECURITY LEVEL



## FEATURES



## TECHNICAL DATA

- 8 mm square profile chain
- Durable, highly flexible IVY Tex synthetic fibre sleeve prevents damage to paintwork
- IVY Tex synthetic fibre slows down cutting attacks and repels dirt/moisture
- The chain, the lock body and supporting elements of the locking mechanism are made of proprietary, specially hardened steel alloys
- Lock body with Softcase Technology for easier handling and prevention of damage to paintwork
- Comes with a user-friendly reversible key

## TECHNOLOGY



## TEST SEALS



1) 24192

Ref. No.	EAN 4003318	⌀ mm	□ cm	Weight g	Carrier	Box Qty
8210/85 black	55152 9	8	85	1800		2
8210/110 black	55153 6	8	110	2200		2
8210/140 black	88288 3	8	140	3185		2

# IVYTEX CHAIN 7210 COLOR

## SECURITY LEVEL



## FEATURES



IVERA RBU



sparkling orange



diving blue



crossing grey



## TECHNICAL DATA

- 7 mm square profile chain
- Durable, highly flexible IVY Tex synthetic fibre sleeve prevents damage to paintwork
- IVY Tex synthetic fibre slows down cutting attacks and repels dirt/moisture
- The chain, the lock body and supporting elements of the locking mechanism are made of proprietary, specially hardened steel alloys
- Comes with a user-friendly reversible key

## TECHNOLOGY



Ref. No.	EAN 4003318	⌀ mm	□ cm	Weight g	Carrier	Box Qty
7210/85 sparkling orange	87777 3	7	85	1300		2
7210/85 racing yellow	87778 0	7	85	1300		2
7210/85 diving blue	87779 7	7	85	1300		2
7210/85 crossing grey	87780 3	7	85	1300		2
7210/110 sparkling orange	87783 4	7	110	1500		2
7210/110 racing yellow	87782 7	7	110	1500		2
7210/110 diving blue	87784 1	7	110	1500		2
7210/110 crossing grey	87781 0	7	110	1500		2
Ivera RBU bracket	58497 8			125	for 7200, 7210, 7220 IVERA	1

# IVYTEX CHAIN 7210

## SECURITY LEVEL



## FEATURES



IVERA RBU



## TECHNICAL DATA

- 7 mm square profile chain
- Durable, highly flexible IVY Tex synthetic fibre sleeve prevents damage to paintwork
- IVY Tex synthetic fibre slows down cutting attacks and repels dirt/moisture
- The chain, the lock body and supporting elements of the locking mechanism are made of proprietary, specially hardened steel alloys
- Comes with a user-friendly reversible key

## TECHNOLOGY



Ref. No.	EAN 4003318	⌀ mm	□ cm	Weight g	Carrier	Box Qty
7210/85	55141 3	7	85	1300		2
7210/110	55142 0	7	110	1500		2
Ivera RBU bracket	58497 8			125	for 7200, 7210, 7220 IVERA	1

# STEEL-O-CHAIN™ 8807K

## SECURITY LEVEL



## FEATURES



## TECHNICAL DATA

- 7 mm thick square chain with webbing sleeve to protect paintwork
- The chain, the lock body and supporting elements of the locking mechanism are made of proprietary, specially hardened steel alloys

## TECHNOLOGY



## TEST SEALS



Ref. No.	EAN 4003318	⌀ mm	----- cm	Weight g	Carrier	Box Qty
8807K/85 black	71195 4	7	85	1600		2
8807K/110 black	82519 4	7	110	1900		2

# TRESOR 1385

## VERSIONS



aqua



coral



brown



## SECURITY LEVEL





Chain locks

## TECHNICAL DATA

- 7 mm square chain with fabric sleeve to prevent damage to the bicycle's paintwork
- The chain is made of specially hardened steel
- Two component moulded digits guarantee life-long visibility
- Special touch protection for higher security against unauthorized access to the code through manipulation of the mechanism
- Individually settable code

## TECHNOLOGY



Ref. No.	EAN 4003318	 mm	 cm	Weight g	Carrier	Box Qty
Tresor 1385/85 black	48566 4	7	85	1050		2
Tresor 1385/85 aqua	48567 1	7	85	1050		2
Tresor 1385/85 coral	48568 8	7	85	1050		2
Tresor 1385/85 brown	48569 5	7	85	1050		2
Tresor 1385/110 black	48628 9	7	110	1350		2

# TRESOR 1385 COLOR

## SECURITY LEVEL



## VERSIONS



## TECHNICAL DATA

- 6 mm square chain with fabric sleeve to prevent damage to the bicycle's paintwork
- The chain is made of specially hardened steel
- Two component moulded digits guarantee life-long visibility
- Special touch protection for higher security against unauthorized access to the code through manipulation of the mechanism
- Individually settable code

## TECHNOLOGY



Ref. No.	EAN 4003318	⌀ mm	□ cm	Weight g	Carrier	Box Qty
Tresor 1385/75 grey star	88010 0	6	75	750		6
Tresor 1385/75 blue mask	88011 7	6	75	750		6
Tresor 1385/75 grey lightning	88012 4	6	75	750		6
Tresor 1385/75 cherry heart	88013 1	6	75	750		6
Tresor 1385/75 black	51133 2	6	75	750		6
Tresor 1385/75 Neon green	71263 0	6	75	750		6
Tresor 1385/75 Neon blue	71262 3	6	75	750		6
Tresor 1385/75 Neon orange	71264 7	6	75	750		6
Tresor 1385/75 Neon pink	71265 4	6	75	750		6



# 6210



## SECURITY LEVEL



## FEATURES



Chain locks

## TECHNICAL DATA

- 6 mm square profile chain durable, highly flexible IVY Tex synthetic fibre sleeve prevents damage to paintwork
- IVY Tex synthetic fibre slows down cutting attacks and repels dirt/moisture
- The chain, the lock body and supporting elements of the locking mechanism are made of proprietary, specially hardened steel alloys
- Comes with a user-friendly reversible key

## TECHNOLOGY



Ref. No.	EAN 4003318	⌀ mm	----- cm	Weight g	Carrier	Box Qty
6210/85 black	89511 1	6	85	867		6
6210/110 black	86738 5	6	110	950		6



# CATENA 6806K

## SECURITY LEVEL



## FEATURES



aqua



coral



brown



## TECHNICAL DATA

- 6 mm thick square chain with webbing sleeve to protect paintwork
- The chain and lock body are made of proprietary, specially hardened steel alloys

## TECHNOLOGY



Ref. No.	EAN 4003318	⌀ mm	□ cm	Weight g	Carrier	Box Qty
6806K/85 black	90169 0	6	85	880		6
6806K/85 aqua	90282 6	6	85	880		6
6806K/85 coral	90284 0	6	85	880		6
6806K/85 brown	90283 3	6	85	880		6
6806K/110 black	82511 8	6	110	950		6

# CATENA 6806K NEON

## SECURITY LEVEL



## FEATURES



Neon green



Neon blue



Neon orange



## TECHNICAL DATA

- 6 mm square chain with webbing sleeve to protect paintwork
- The chain and lock body are made of proprietary, specially hardened steel alloys

## TECHNOLOGY



Ref. No.	EAN 4003318	⌀ mm	□ cm	Weight g	Carrier	Box Qty
6806K/85 Neon green	90290 1	6	85	850		6
6806K/85 Neon blue	90289 5	6	85	850		6
6806K/85 Neon orange	90291 8	6	85	850		6
6806K/85 Neon pink	90292 5	6	85	850		6

# CATENA 6806K COLOR

## SECURITY LEVEL



## FEATURES



## VERSIONS



grey star



blue mask



grey lightning

## TECHNICAL DATA

- 6 mm square chain with webbing sleeve to protect paintwork
- The chain and lock body are made of proprietary, specially hardened steel alloys

## TECHNOLOGY



Ref. No.	EAN 4003318	mm	cm	Weight g	Carrier	Box Qty
6806K/85 cherry heart	90288 8	6	85	850		6
6806K/85 blue mask	90286 4	6	85	850		6
6806K/85 grey lightning	90287 1	6	85	850		6
6806K/85 grey star	90285 7	6	85	850		6

# CATENA 6806K REFLECTIVE

NEW



## SECURITY LEVEL



## FEATURES



Chain locks

## TECHNICAL DATA



- 6 mm thick square chain with textile sleeve that prevents damage to paintwork
- The chain is made of specially hardened steel
- New reflective webbing sleeve

## TECHNOLOGY



## TEST SEALS



Ref. No.	EAN 4003318	 mm	 cm	Weight g	Carrier	Box Qty
6806K/85 reflective	69104 1	6	85	850		6
6806K/110 reflective	69105 8	6	110	950		6

# 6806K CLASSIC

SECURITY LEVEL



FEATURES



TECHNICAL DATA

- 6 mm thick square chain with textile sleeve that prevents damage to paintwork
- The chain is made of specially hardened steel

TECHNOLOGY



TEST SEALS



Ref. No.	EAN 4003318	⌀ mm	●●●●● cm	Weight g	Carrier	Box Qty
6806K/85 Classic	90057 0	6	85	689		6
6806K/110 Classic	90056 3	6	110	800		6

# STEEL-O-CHAIN™ 5805K

## VERSIONS



blue



red



lime



pink



## SECURITY LEVEL



## FEATURES



Chain locks

## TECHNICAL DATA

- 5 mm square chain with webbing sleeve to protect paintwork
- The chain is made of proprietary steel alloy

## TECHNOLOGY



Ref. No.	EAN 4003318	⌀ mm	□ cm	Weight g	Carrier	Box Qty
5805K/75 black	71205 0	5	75	590		6
5805K/75 blue	72490 9	5	75	590		6
5805K/75 red	72489 3	5	75	590		6
5805K/75 lime	72491 6	5	75	590		6
5805K/75 pink	72492 3	5	75	590		6
5805K/110 black	72493 0	5	110	780		6

# STEEL-O-CHAIN™ 5805C

## SECURITY LEVEL



## VERSIONS



blue



red



lime



pink

## TECHNICAL DATA

- 5 mm thick square chain with webbing sleeve to protect paintwork
- The chain is made of proprietary steel alloy
- Two-component number reels guarantee long-term readability of the digits
- The number code can be set individually

## TECHNOLOGY



Ref. No.	EAN 4003318	⌀ mm	□ cm	Weight g	Carrier	Box Qty
5805C/75 black	71206 7	5	75	500		6
5805C/75 blue	72494 7	5	75	500		6
5805C/75 red	72495 4	5	75	500		6
5805C/75 lime	72496 1	5	75	500		6
5805C/75 pink	72497 8	5	75	500		6
5805C/110 black	72498 5	5	110	720		6



# STEEL-O-CHAIN™ 4804K

## VERSIONS



blue



red



lime



pink



## SECURITY LEVEL



## FEATURES



Chain locks

## TECHNICAL DATA

- 4 mm thick square chain with webbing sleeve to protect paintwork
- The chain is made of proprietary steel alloy

## TECHNOLOGY



Ref. No.	EAN 4003318	mm	cm	Weight g	Carrier	Box Qty
4804K/75 black	72483 1	4	75	380		6
4804K/75 blue	72484 8	4	75	380		6
4804K/75 red	72485 5	4	75	380		6
4804K/75 lime	72486 2	4	75	380		6
4804K/75 pink	72487 9	4	75	380		6
4804K/110 black	72488 6	4	110	520		6

# STEEL- O- CHAIN™ 4804C SYMBOLS

## SECURITY LEVEL



## VERSIONS



Symbols blue



Symbols pink



Symbols red



## TECHNICAL DATA

- 4 mm square with webbing sleeve to protect paintwork
- The chain is made of proprietary steel alloy
- Playful easy use for children due to symbols instead of digits
- Individually settable code

## TECHNOLOGY



Ref. No.	EAN 4003318	⌀ mm	----- cm	Weight g	Carrier	Box Qty
4804C/75 blue SYMBOLS	86809 2	4	75	360		6
4804C/75 pink SYMBOLS	86810 8	4	75	360		6
4804C/75 red SYMBOLS	87499 4	4	75	360		6
4804C/75 lime SYMBOLS	87498 7	4	75	360		6

# STEEL-O-CHAIN™ 4804C

## VERSIONS



blue



red



lime



pink



## SECURITY LEVEL





Chain locks

## TECHNICAL DATA

- 4 mm thick square chain with webbing sleeve to protect paintwork
- The chain is made of proprietary steel alloy
- Individually settable code

## TECHNOLOGY



Ref. No.	EAN 4003318	 mm	 cm	Weight g	Carrier	Box Qty
4804C/75 black	71617 1	4	75	360		6
4804C/75 blue	71616 4	4	75	360		6
4804C/75 red	72468 8	4	75	360		6
4804C/75 lime	72480 0	4	75	360		6
4804C/75 pink	72481 7	4	75	360		6
4804C/110 black	72482 4	4	110	480		6

# 1500 WEB

## SECURITY LEVEL



## FEATURES



## VERSIONS



lime



orange



red



coral





white

## TECHNICAL DATA

- 4 mm round chain with webbing sleeve to protect paintwork
- The chain is made of proprietary steel alloy

## TECHNOLOGY



Ref. No.	EAN 4003318	 mm	 cm	Weight g	Carrier	Box Qty
1500/60 web black	56345 4	4	60	230		12
1500/60 web lime	56344 7	4	60	230		12
1500/60 web orange	56920 3	4	60	230		12
1500/60 web red	56343 0	4	60	230		12
1500/60 web white	56921 0	4	60	230		12
1500/60 web coral	57895 3	4	60	230		12
1500/60 web color	57658 4	4	60	230		12
1500/110 web black	56346 1	4	110	360		12
1500/110 web color	57659 1	4	110	360		12

# 1200 WEB

## VERSIONS



lime



orange



red



white



coral





## SECURITY LEVEL



Chain locks

## TECHNICAL DATA

- 4 mm thick rounded chain with webbing sleeve to protect paintwork
- The chain is made of proprietary steel alloy

Ref. No.	EAN 4003318	 mm	 cm	Weight g	Carrier	Box Qty
1200/60 web black	56341 6	4	60	200		12
1200/60 web lime	56340 9	4	60	200		12
1200/60 web orange	56922 7	4	60	200		12
1200/60 web red	56339 3	4	60	200		12
1200/60 web white	56924 1	4	60	200		12
1200/60 web coral	57893 9	4	60	200		12
1200/60 web color	57656 0	4	60	200		12
1200/110 web black	56342 3	4	110	330		12
1200/110 web color	57657 7	4	110	330		12

**STEEL-O-FLEX LOCKS**



**STEEL-O-FLEX™**

**950**



black

Page 78

**IVEN STEEL-O-FLEX™**

**8200**



black

Page 79

**IVERA STEEL-O-FLEX™**

**7200**



black

Page 80

**CENTURO**

**860**



black

Page 81

**PHANTOM™**

**8960**



black

Page 82

**STEEL-O-FLEX™ RAYDO**

**PRO 1460**



black

Page 83

**STEEL-O-FLEX™ TRESOR**

**1360**



black

Page 84

**MICROFLEX**

**6615K**



black

Page 85

**TRESORFLEX**

**6615C**



black

Page 85

# STEEL- O- FLEX™ 950

## SECURITY LEVEL



## FEATURES



Plus



UGH 02





## TECHNICAL DATA

- 25 mm thick, overlapping steel shells protect the internal steel cable
- Synthetic coating to prevent damage to the bicycle's paintwork
- The steel shells, the case as well as supporting elements of the locking mechanism are made of specially hardened steel
- ABUS Plus cylinder for high protection against manipulations, e.g. picking
- Manually operated cover for the keyhole against dirt and corrosion
- Available keyed alike to many other ABUS Plus cylinder locks

## TEST SEALS



Ref. No.	EAN 4003318	 mm	 cm	Weight g	Carrier	Box Qty
950/100	25715 5	25	100	1540		2
Bracket UGH 02	26624 9			80	replacement bracket	1



# IVEN STEEL-O-FLEX™ 8200



## SECURITY LEVEL



## FEATURES



UGH 02

Steel-O-Flex Locks

## TECHNICAL DATA



- 25 mm thick, overlapping steel shells protect the internal steel cable
- The steel shells, the case as well as supporting elements of the locking mechanism are made of specially hardened steel
- Ergonomic lock body with softcase technology to prevent damage to the bicycle's paintwork
- Durable, highly flexible IVY Tex synthetic fibre sleeve prevents damage to paintwork
- IVY Tex synthetic fibre slows down cutting attacks and repels dirt/moisture

## TECHNOLOGY



## TEST SEALS



Ref. No.	EAN 4003318	 mm	 cm	Weight g	Carrier	Box Qty
8200/85	55148 2	25	85	1340		6
8200/110	55149 9	25	110	1580		2
Bracket UGH 02	26624 9			80	replacement bracket	1

# IVERA STEEL- O- FLEX™ 7200

## SECURITY LEVEL



## FEATURES



IVERA RBU



## TECHNICAL DATA



- 22 mm thick, overlapping steel shells protect the internal steel cable
- Durable, highly flexible IVY Tex synthetic fibre sleeve prevents damage to paintwork
- IVY Tex synthetic fibre slows down cutting attacks and repels dirt/moisture
- The steel shells, the housing and the structural parts of the locking mechanism are manufactured using proprietary, specially hardened steel alloys

## TECHNOLOGY



## TEST SEALS



Ref. No.	EAN 4003318	 mm	 cm	Weight g	Carrier	Box Qty
7200/85	55137 6	22	85	700		6
7200/85 + RBU	55139 0	22	85	840	RBU	6
7200/110	55138 3	22	110	860		6
7200/110 + RBU	55140 6	22	110	860	RBU	6
Bracket IVERA RBU	58497 8			125	replacement bracket	1

# CENTURO 860



## SECURITY LEVEL



## FEATURES



QuickSnap RBU

Steel-O-Flex Locks

## TECHNICAL DATA



- 20 mm thick, overlapping steel shells protect the internal steel cable
- Plastic coating to prevent damage to the bicycle's paintwork
- The steel shells, the case as well as supporting elements of the locking mechanism are made of specially hardened steel

## TECHNOLOGY



## TEST SEALS



Ref. No.	EAN 4003318	 mm	 cm	Weight g	Carrier	Box Qty
860/85	31495 7	20	85	780		6
860/85 QS RBU	31493 3	20	85	825	QuickSnap RBU	6
860/110	31496 4	20	110	980		6
860/110 QS RBU	31494 0	20	110	980	QuickSnap RBU	6

# PHANTOM™ 8960

## SECURITY LEVEL



## FEATURES



Double Protection



TexFL



KF



## TECHNICAL DATA



- 17 mm thick, overlapping steel shells protect the internal steel cable
- Plastic coating to prevent damage to the bicycle's paintwork
- The shells, body and the structural parts of the locking mechanism are made of specially hardened steel
- ABUS Extra Classe (EC) automatic cylinder with coded reversible key

## TECHNOLOGY



## TEST SEALS



Ref. No.	EAN 4003318	 mm	 cm	Weight g	Carrier	Box Qty
8960/85 KF	78595 5	17	85	700	KF	6
8960/85 TexFL	39680 9	17	85	720	TexFL	6
8960/110 TexFL	39683 0	17	110	920	TexFL	6

# STEEL-O-FLEX™ RAYDO PRO 1460



## SECURITY LEVEL



## FEATURES



Combo Light



TexKF



KF

Steel-O-Flex Locks

## TECHNICAL DATA



- 20 mm thick, overlapping steel shells protect the internal steel cable
- Plastic coating to prevent damage to the bicycle's paintwork
- The steel sleeves are manufactured using specially hardened steel
- Individually configurable code
- Press'n Shine function – LED-lit number dial for easy handling in the dark

## TECHNOLOGY



## TEST SEALS



Ref. No.	EAN 4003318			Weight g	Carrier	Box Qty
		mm	cm			
1460/85 TexKF	59217 1	20	85	780	TexKF	6
1460/85 KF	59216 4	20	85	780	KF	6

# STEEL- O- FLEX™ TRESOR 1360

## SECURITY LEVEL



## FEATURES



Double Protection



## TECHNICAL DATA



- 20 mm thick, overlapping steel shells protect the internal steel cable
- Plastic coating to prevent damage to the bicycle's paintwork
- Two-component number dials ensure long-term readability of the digits
- Special touch protection for increased security against unauthorised access to the code through manipulation of the mechanism
- Dark-touch function facilitates use in the dark thanks to special imprinting
- Individually configurable code

## TECHNOLOGY



## TEST SEALS



Ref. No.	EAN 4003318	 mm	 cm	Weight g	Carrier	Box Qty
1360/85 black	42935 4	20	85	680		6
1360/110 black	42934 7	20	110	880		6

# MICROFLEX 6615K

## SECURITY LEVEL



## FEATURES



SCMU



SCLL





## TECHNICAL DATA

- 15 mm thick, overlapping steel shells protect the internal steel cable
- Plastic coating protects the bicycle's paintwork
- Available individually or with SCMU / SCLL bracket

## TECHNOLOGY



Ref. No.	EAN 4003318	 mm	 cm	Weight g	Carrier	Box Qty
6615K/85/15 black	13410 4	15	85	540		6
6615K/85/15 black SCMU	13408 1	15	85	580	SCMU	6
6615K/85/15 black SCLL	86174 1	15	85	580	SCLL	6
6615K/120/15 black	13412 8	15	120	700		6
6615K/120/15 black SCMU	13409 8	15	120	760	SCMU	6
6615K/120/15 black SCLL	86172 7	15	120	760	SCLL	6

# TRESORFLEX 6615C

## SECURITY LEVEL



## FEATURES



SCMU



SCLL





## TECHNICAL DATA

- 15 mm thick, overlapping steel shells protect the internal steel cable
- Plastic coating to prevent damage to the bicycle's paintwork
- Two-component number dials ensure long-term readability of the digits
- Special touch protection for increased security against unauthorised access to the code through manipulation of the mechanism
- Dark-touch function facilitates use in the dark thanks to special imprinting
- Individually configurable code
- Available individually or with SCMU / SCLL bracket

## TECHNOLOGY



Ref. No.	EAN 4003318	 mm	 cm	Weight g	Carrier	Box Qty
6615C/85/15 black	13659 7	15	85	560		6
6615C/85/15 black SCMU	13657 3	15	85	705	SCMU	6
6615C/85/15 black SCLL	86173 4	15	85	705	SCLL	6
6615C/120/15 black	13780 8	15	120	720		6
6615C/120/15 black SCMU	13658 0	15	120	780	SCMU	6
6615C/120/15 black SCLL	86171 0	15	120	780	SCLL	6

**COIL CABLE- & CABLE LOCKS**





**PHANTOM™  
8950**



black

Page 90

**RAYDO PRO  
1450**



black

Page 91

**BOOSTER  
6512K**



black

Page 92

**TRESOR  
6512C**



black

Page 92

**PRIMO  
5510K**



black

Page 93

**NUMERO  
5510C**



black

Page 93

**STAR  
4508K**



black

Page 94



blue

Page 94



red

Page 94



green

Page 94

**STAR  
4508C**



black

Page 94



blue

Page 94



red

Page 94



green

Page 94

**3506K**



black

Page 95



blue

Page 95



orange

Page 95



red

Page 95



green

Page 95



pink

Page 95



silver

Page 95



black

Page 95



blue

Page 95



orange

Page 95



red

Page 95



green

Page 95



pink

Page 95

**3506C**



silver

Page 95



black

Page 96

**IVERA CABLE**

**7220**



black

Page 98

**RACER**

**6412K**



black

Page 98

**TRESOR**

**6412C**



black

Page 99

**PRIMO**

**5410K**



black

Page 99

**NUMERINO**

**5410C**



black

Page 100

**4408K**



blue

Page 100



red

Page 100



green

Page 100



black

Page 100

**4408C**



blue

Page 100



red

Page 100



green

Page 100

**3406K**



black

Page 101



blue

Page 101



orange

Page 101



red

Page 101



green

Page 101



pink

Page 101



silver

Page 101

**3406C**



black

Page 101



blue

Page 101



orange

Page 101



red

Page 101



green

Page 101



pink

Page 101

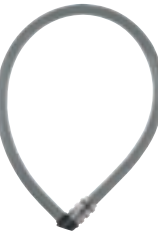

silver

Page 101

# PHANTOM™ 8950

## SECURITY LEVEL



## FEATURES



KF



TexKF



TexFL





## TECHNICAL DATA

- 12 or 15 mm thick, high-quality and super flexible spiral cable
- Plastic coating in matte black look to prevent damage to the bicycle's paintwork
- ABUS Extra Classe (EC) automatic cylinder with coded reversible key

## TECHNOLOGY



Ref. No.	EAN 4003318	 mm	 cm	Weight g	Carrier	Box Qty
8950/180 KF	39685 4	12	180	645	KF	6
8950/180 TexKF	39684 7	12	180	655	TexKF	6
8950/180 TexFL	39802 5	15	180	665	TexFL	6

# RAYDO PRO 1450



## SECURITY LEVEL



## FEATURES



Combo Light



TexKF



Coil cable- & cable locks

## TECHNICAL DATA

- 12 mm thick, high-quality and super flexible spiral cable
- Plastic coating to prevent damage to the bicycle's paintwork
- Individually configurable code
- Press'n Shine function – LED-lit number dials for easy handling in the dark

## TECHNOLOGY



Ref. No.	EAN 4003318	 mm	 cm	Weight g	Carrier	Box Qty
1450/185 black TexKF	59214 0	12	185	718	TexKF	6

# BOOSTER 6512K

## SECURITY LEVEL



## FEATURES



SCMU



SCLL



SR



## TECHNICAL DATA

- 12 mm thick, high-quality and super flexible spiral cable
- Plastic coating to prevent damage to the bicycle's paintwork
- Available individually or with a choice of SCMU, SCLL or new SR bracket

## TECHNOLOGY



Ref. No.	EAN 4003318	mm	cm	Weight g	Carrier	Box Qty
6512K/180 black	13400 5	12	180	531		6
6512K/180 black SCMU	13399 2	12	180	573	SCMU	6
6512K/180 black SCLL	86170 3	12	180	573	SCLL	6
6512K/180 black SR	61470 5	12	180	573	SR	6

# TRESOR 6512C

## SECURITY LEVEL



## FEATURES



SCMU



SCLL



SR



## TECHNICAL DATA

- 12 mm thick, high-quality and super flexible spiral cable
- Plastic coating to prevent damage to the bicycle's paintwork
- 2-component number dialss guarantee long-term readability of the digits
- Individually configurable code
- Available individually or with a choice of SCMU, SCLL or new SR bracket

## TECHNOLOGY



Ref. No.	EAN 4003318	mm	cm	Weight g	Carrier	Box Qty
6512C/180 black	13415 9	12	180	549		6
6512C/180 black SCMU	13414 2	12	180	600	SCMU	6
6512C/180 black SCLL	86169 7	12	180	600	SCLL	6
6512C/180 black SR	61471 2	12	180	600	SR	6

# PRIMO 5510K

## SECURITY LEVEL



## FEATURES



SCMU



SCLL



SR



## TECHNICAL DATA

- 10 mm thick, high-quality and super flexible spiral cable
- Plastic coating to prevent damage to the bicycle's paintwork
- Available individually or with a choice of SCMU, SCLL or new SR bracket

## TECHNOLOGY



Ref. No.	EAN 4003318	mm	cm	Weight g	Carrier	Box Qty
5510K/180 black	14260 4	10	180	460		6
5510K/180 black SCMU	14245 1	10	180	508	SCMU	6
5510K/180 black SCLL	86168 0	10	180	508	SCLL	6
5510K/180 black SR	61468 2	10	180	508	SR	6

# NUMERO 5510C

## SECURITY LEVEL



## FEATURES



SCMU



SCLL



SR



## TECHNICAL DATA

- 10 mm thick, high-quality and super flexible spiral cable
- Plastic coating to prevent damage to the bicycle's paintwork
- Dark-touch function facilitates use in the dark thanks to special imprinting
- Individually configurable code
- Available individually or with a choice of SCMU, SCLL or new SR bracket

## TECHNOLOGY



Ref. No.	EAN 4003318	mm	cm	Weight g	Carrier	Box Qty
5510C/180 black	16524 5	10	180	459		6
5510C/180 black SCMU	16523 8	10	180	508	SCMU	6
5510C/180 black SCLL	86167 3	10	180	571	SCLL	6
5510C/180 black SR	61469 9	10	180	508	SR	6

## STAR 4508K

### SECURITY LEVEL



### FEATURES



blue



red



green



### TECHNICAL DATA

- 8 mm thick, high-quality and super flexible spiral cable
- Plastic coating to prevent damage to the bicycle's paintwork
- Supplied without bracket

### TECHNOLOGY



Ref. No.	EAN 4003318	mm	cm	Weight g	Carrier	Box Qty
4508K/150 black	20016 8	8	150	280		12
4508K/150 blue	40775 8	8	150	280		12
4508K/150 red	40776 5	8	150	280		12
4508K/150 green	40777 2	8	150	280		12

## STAR 4508C

### SECURITY LEVEL



blue



red



lime



### TECHNICAL DATA

- 8 mm thick, high-quality and super flexible coil cable
- Plastic coating protects the bicycle's paint
- Dark-touch function facilitates use in the dark thanks to special moulding
- Individually configurable code
- Supplied without bracket

### TECHNOLOGY



Ref. No.	EAN 4003318	mm	cm	Weight g	Carrier	Box Qty
4508C/150 black	20019 9	8	150	260		12
4508C/150 blue	40778 9	8	150	260		12
4508C/150 red	40779 6	8	150	260		12
4508C/150 green	40780 2	8	150	260		12



# 3506K

## SECURITY LEVEL



## TECHNICAL DATA

- 6 mm thick and super flexible spiral cable
- Plastic coating to prevent damage to the bicycle's paintwork
- Supplied without bracket



blue



orange



red



green



pink



silver

Ref. No.	EAN 4003318	mm	cm	Weight g	Carrier	Box Qty
3506K/120 black	40769 7	6	120	182		12
3506K/120 Color	40770 3	6	120	182		12
3506K/180 black	40771 0	6	180	228		12

# 3506C

## SECURITY LEVEL



## TECHNICAL DATA

- 6 mm thick and super flexible spiral cable
- Plastic coating to prevent damage to the bicycle's paintwork
- Numerical code set at the factory
- Supplied without bracket

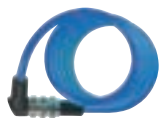

blue



orange



red



green



pink



silver

Ref. No.	EAN 4003318	mm	cm	Weight g	Carrier	Box Qty
3506C/120 black	40772 7	6	120	154		12
3506C/120 Color	40773 4	6	120	154		12
3506C/180 black	40774 1	6	180	200		12

# IVERA CABLE 7220

## SECURITY LEVEL



## FEATURES



IVERA RBU



## TECHNICAL DATA



- 20 mm thick, high-quality steel cable
- Durable, highly flexible IVY Tex synthetic fibre sleeve prevents damage to paintwork
- IVY Tex synthetic fibre slows down cutting attacks and repels dirt/moisture
- The body and structural parts of the locking mechanism are manufactured using specially hardened steel

## TECHNOLOGY



## TEST SEALS



Ref. No.	EAN 4003318	 mm	 cm	Weight g	Carrier	Box Qty
7220/85 black	55145 1	20	85	660		6
Bracket IVERA RBU	58497 8			125	replacement bracket	1



# RACER 6412K

## SECURITY LEVEL



## FEATURES



SCMU



SCLL



SR



## TECHNICAL DATA

- 12 mm thick, high-quality super flexible steel coil cable
- Plastic coating to prevent damage to the bicycle's paintwork
- Available individually or with a choice of SCMU, SCLL or new SR bracket

## TECHNOLOGY



Ref. No.	EAN 4003318	mm	cm	Weight g	Carrier	Box Qty
6412K/85 black	40804 5	12	85	386		6
6412K/85 black SCMU	40805 2	12	85	387	SCMU	6
6412K/85 black SCLL	40806 9	12	85	419	SCLL	6
6412K/85 black SR	61476 7	12	85	387	SR	6
6412K/120 black	63491 8	12	120	492		6
6412K/120 black SCMU	63492 5	12	120	535	SCMU	6
6412K/120 black SCLL	63529 8	12	120	535	SCLL	6
6412K/120 black SR	63530 4	12	120	535	SR	6

# TRESOR 6412C

## SECURITY LEVEL



## FEATURES



SCMU



SCLL



SR



## TECHNICAL DATA

- 12 mm thick, high-quality steel cable
- Plastic coating protects the bicycle's paint
- Dark-touch function enables use in the dark, thanks to special number embossing
- Two-component number dials ensure long-term readability of the digits
- The number code can be set individually
- Available individually or with a choice of SCMU, SCLL or new SR bracket

## TECHNOLOGY



Ref. No.	EAN 4003318	mm	cm	Weight g	Carrier	Box Qty
6412C/85 black	40807 6	12	85	396		6
6412C/85 black SCMU	40808 3	12	85	441	SCMU	6
6412C/85 black SCLL	40809 0	12	85	419	SCLL	6
6412C/85 black SR	61477 4	12	85	441	SR	6
6412C/120 black	63489 5	12	120	503		6
6412C/120 black SCMU	63490 1	12	120	560	SCMU	6
6412C/120 black SCLL	63527 4	12	120	560	SCLL	6
6412C/120 black SR	63528 1	12	120	560	SR	6

# PRIMO 5410K

## SECURITY LEVEL



## FEATURES



SCMU



SCLL



SR



## TECHNICAL DATA

- 10 mm thick, high-quality steel cable
- Plastic coating protects the bicycle's paint
- Available individually or with a choice of SCMU, SCLL or new SR bracket

## TECHNOLOGY



Ref. No.	EAN 4003318	mm	cm	Weight g	Carrier	Box Qty
5410K/85 black	40798 7	10	85	278		6
5410K/85 black SCMU	40799 4	10	85	330	SCMU	6
5410K/85 black SCLL	40800 7	10	85	334	SCLL	6
5410K/85 black SR	61474 3	10	85	324	SR	6

# NUMERINO 5410C

## SECURITY LEVEL



## FEATURES



SCMU



SCLL



SR



## TECHNICAL DATA

- 10 mm thick, high-quality steel cable
- Plastic coating protects the bicycle's paint
- Dark-touch function enables use in the dark, thanks to special number embossing
- Two-component number dialls ensure long-term readability of the digits
- The number code can be set individually
- Available individually or with a choice of SCMU, SCLL or new SR bracket

## TECHNOLOGY



Ref. No.	EAN 4003318	mm	cm	Weight g	Carrier	Box Qty
5410C/85 black	40801 4	10	85	276		6
5410C/85 black SCMU	40802 1	10	85	330	SCMU	6
5410C/85 black SCLL	40803 8	10	85	334	SCLL	6
5410C/85 black SR	61475 0	10	85	320	SR	6

# 4408K

## SECURITY LEVEL



blue



red



green

Ref. No.	EAN 4003318	mm	cm	Weight g	Carrier	Box Qty
4408K/65 black	40790 1	8	65	271		12
4408K/65 blue	40791 8	8	65	271		12
4408K/65 red	40792 5	8	65	271		12
4408K/65 green	40793 2	8	65	271		12

## TECHNICAL DATA

- 8 mm thick steel cable
- Plastic coating to prevent damage to the bicycle's paintwork
- Supplied without bracket

# 4408C

## SECURITY LEVEL



blue



red



green

Ref. No.	EAN 4003318	mm	cm	Weight g	Carrier	Box Qty
4408C/65 black	40794 9	8	65	271		12
4408C/65 blue	40795 6	8	65	271		12
4408C/65 red	40796 3	8	65	271		12
4408C/65 green	40797 0	8	65	271		12

## TECHNICAL DATA

- 8 mm thick steel cable
- Plastic coating to prevent damage to the bicycle's paintwork
- Individually configurable code
- Supplied without bracket

## TECHNOLOGY



# 3406K

## SECURITY LEVEL



## TECHNICAL DATA

- 6 mm thick steel cable
- Plastic coating to prevent damage to the bicycle's paintwork
- Supplied without bracket



blue



orange



red



green



pink



silver

Ref. No.	EAN 4003318	mm	cm	Weight g	Carrier	Box Qty
3406K/55 black	40782 6	6	55	139		12
3406K/55 Color	40785 7	6	55	139		12

# 3406C

## SECURITY LEVEL



## TECHNICAL DATA

- 6 mm thick steel cable
- Plastic coating to prevent damage to the bicycle's paintwork
- Numerical code set at the factory
- Supplied without bracket



blue



orange



red



green



pink



silver

Ref. No.	EAN 4003318	mm	cm	Weight g	Carrier	Box Qty
3406C/55 black	40787 1	6	55	114		12
3406C/55 Color	40789 5	6	55	114		12

**FRAME LOCKS AND BATTERY LOCKS**





**PRO SHIELD XPLUS™**  
**5955**



black

Page 106

**SHIELD XPLUS™**  
**5755L**

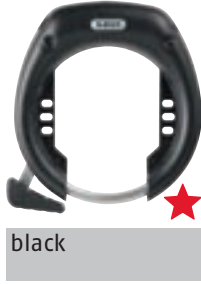

black

Page 107

**PRO AMPARO**  
**4750X / XL**



black

Page 108

**PRO AMPARO**  
**4750S / SL**



black

Page 109

**4650X / XL**



black

Page 110

**4650S / SL**

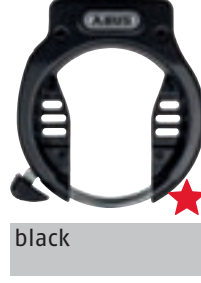

black

Page 111

**PRO TECTIC™**  
**4960**



black

Page 112

**TECTIC™**  
**496**



black

Page 113

**ADAPTOR**  
**CHAIN**



black

Page 114

**ADAPTOR**  
**CABLE**



black

Page 114

**IVYTEX**  
**ADAPTOR CHAIN**

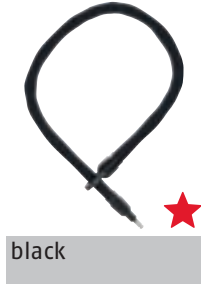

black

Page 115



crossing grey

Page 115



sparkling orange

Page 115

# FRAME LOCKS

We want to help you find the right frame lock for your customer's bike even faster in the future. The dimensioning below should help you with this.

Please also ask your ABUS contact for a custom gage (item no.: 90342). The template is designed so that you can put it in the right place on the tire and directly read which lock is the right one.

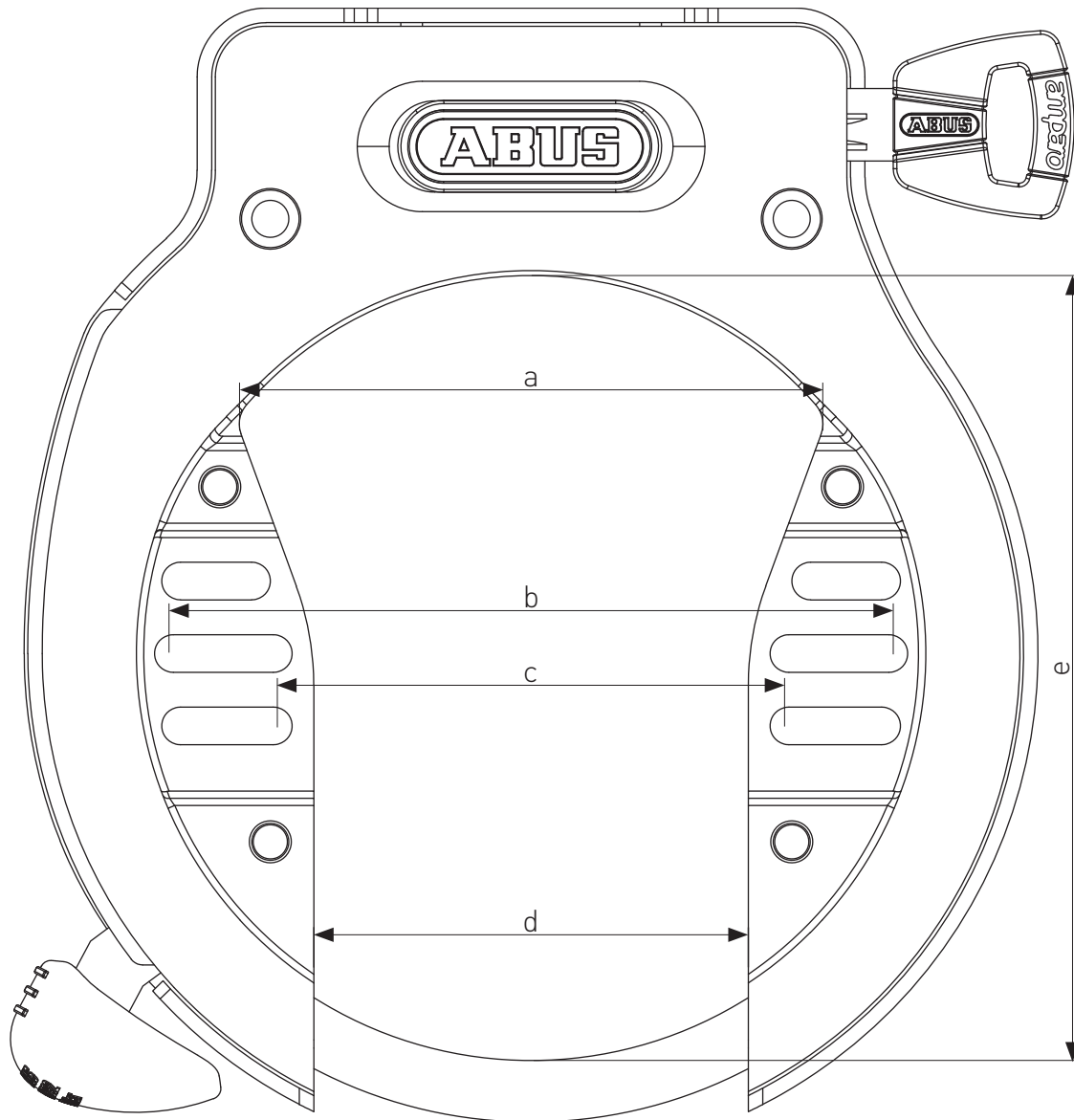

- a Maximum fender width
- b Maximum hole spacing of rear mounting points
- c Minimum hole spacing of rear mounting points
- d Maximum tire width
- e Maximum clearance heights (top of fender vs rim)

You will find an overview of all dimensions on the next page. In addition, you will also find all relevant dimensions on each product page in the tables.

Ref. No.	EAN	a	b	c	d	e	Weight	Box	RRP
	4003318	mm	mm	mm	mm	mm	g	Qty	incl. VAT €

# ALL FRAME LOCK DIMENSIONS IN OVERVIEW

**5955**

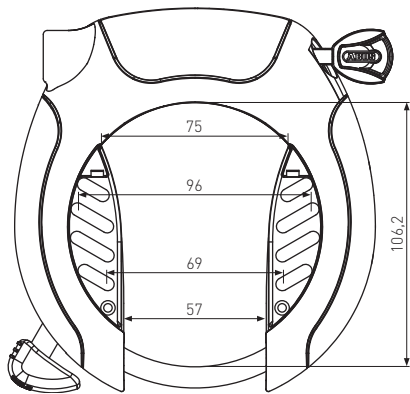

**5755L**

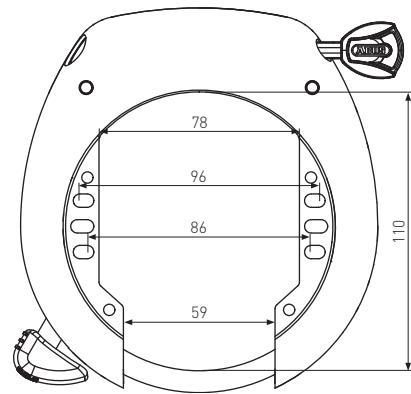

**4750X / 4750XL**

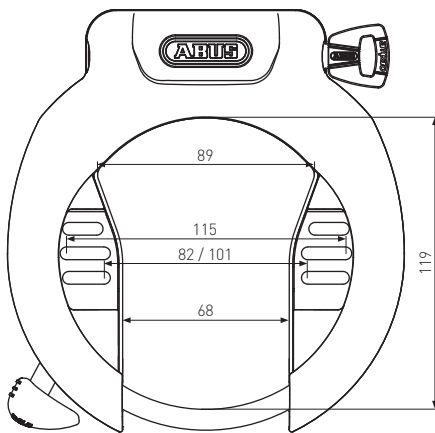

**4750S / 4750SL**

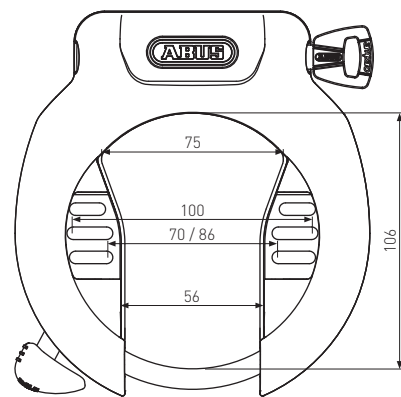

**4650X / 4650XL**

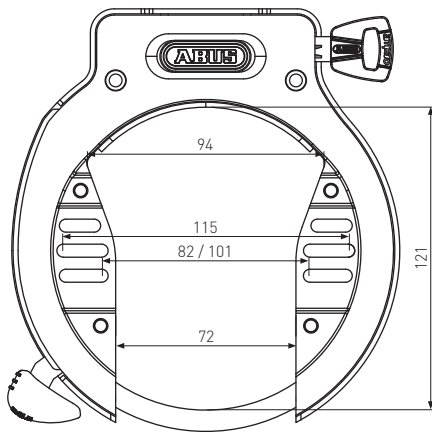

**4650S / 4650SL**

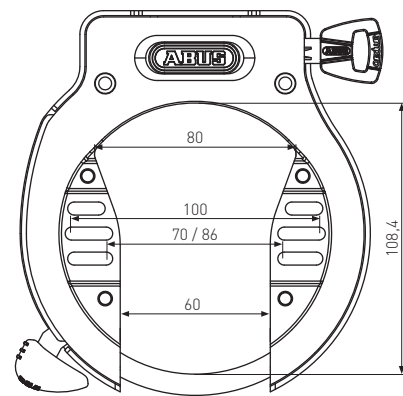

**4960**

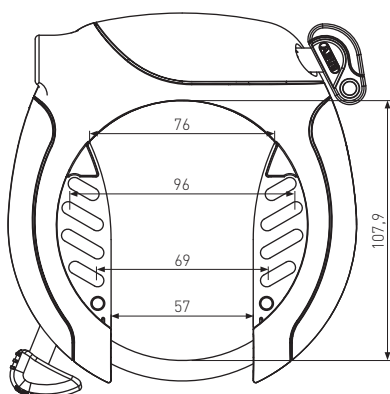

**496**

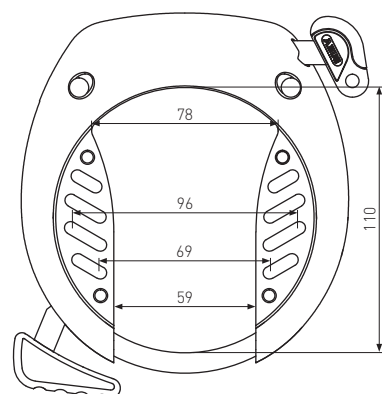

Frame locks and  
battery locks

All dimensions in mm.

# PRO SHIELD XPLUS™ 5955

★  
NEW

## SECURITY LEVEL



## VERSIONS



## FEATURES



XPlus™



SH



Mounting straps



## TECHNICAL DATA

- 8.5 mm thick locking shackle
- The shackle, the case as well as supporting elements of the locking mechanism are made proprietary, specially hardened steel alloys
- Accessories can easily be fitted to the locking mechanism on the lock housing
- ABUS XPlus cylinder for high protection against manipulation
- The R (key retaining) version holds the key when the lock is open, the NR (non key retaining) version allows the key to be removed
- Available keyed alike to any ABUS XPLUS cylinder

## TECHNOLOGY



## TEST SEALS



1) only for R-versions 2) applied for

Ref. No.	EAN 4003318	a mm	b mm	c mm	d mm	e mm	Weight g	Box Qty
5955 NR black	69082 2	75	96	69	57	106,2	660	6
5955 NR OE black	69084 6	75	96	69	57	106,2	660	15
5955 R black	69083 9	75	96	69	57	106,2	660	6
5955 R OE black	69085 3	75	96	69	57	106,2	660	15
5955 NR black + 6KS/85 + ST 5950	69086 0	75	96	69	57	106,2	1500	1
5955 NR black + 6KS/100 + ST 5950	69087 7	75	96	69	57	106,2	1600	1
Bracket SH	37552 1						56	6
Mounting straps	56240 2						48	6

# SHIELD XPLUS™ 5755L

NEW



## SECURITY LEVEL



## FEATURES



XPlus™



SH



Mounting straps

## TECHNICAL DATA

- 8.5 mm thick locking shackle
- The shackle, the case as well as supporting elements of the locking mechanism are made proprietary, specially hardened steel alloys
- Accessories can easily be fitted to the locking mechanism on the lock housing
- ABUS XPlus cylinder for high protection against manipulation
- The R (key retaining) version holds the key when the lock is open, the NR (non key retaining) version allows the key to be removed
- Available keyed alike to any ABUS XPlus cylinder

## TECHNOLOGY



## TEST SEALS



1) only for R-versions 2) applied for

Frame locks and  
battery locks

Ref. No.	EAN 4003318	a mm	b mm	c mm	d mm	e mm	Weight g	Box Qty
5755L NR BK OE	69088 4	78	96	86	59	110	570	6
5755L R BK OE	69089 1	78	96	86	59	110	570	6
Bracket SH	37552 1						56	6
Mounting straps	56240 2						48	6

# PRO AMPARO 4750X / XL

## SECURITY LEVEL



## FEATURES



SH



Mounting straps



## TECHNICAL DATA

- 8.5 mm steel shackle
- The case, the shackle as well as supporting elements of the locking mechanism are made of specially hardened steel
- Extreme large aperture for extra wide tires
- Closing mechanism for easy attachment of accessory to the lock body
- The R (key retaining) version holds the key when the lock is open, the NR (non key retaining) version allows taking the key out of the cylinder

## TECHNOLOGY



## TEST SEALS



1) only for R-versions 2) 35482

Ref. No.	EAN 4003318	a mm	b mm	c mm	d mm	e mm	Weight g	Box Qty
4750X NR BK PRO AMPARO	69349 6	89	115	82	68	119	850	12
4750X NR BK OE	86734 7	89	115	82	68	119	850	12
4750X R BK PRO AMPARO	69352 6	89	115	82	68	119	850	12
4750X R BK OE	86735 4	89	115	82	68	119	850	12
4750XL NR BK PRO AMPARO	69353 3	89	115	101	68	119	850	12
4750XL NR BK OE	86736 1	89	115	101	68	119	850	12
4750XL R BK PRO AMPARO	69354 0	89	115	101	68	119	850	12
4750XL R BK OE	86737 8	89	115	101	68	119	850	12
Bracket SH	37552 1						56	6
Mounting straps	56240 2						48	6

# PRO AMPARO 4750S / SL

NEW



## SECURITY LEVEL



## FEATURES



SH



Mounting straps

## TECHNICAL DATA

- 8.5 mm steel shackle
- The case, the shackle as well as supporting elements of the locking mechanism are made of proprietary, specially hardened steel alloys
- Closing mechanism for easy attachment of accessory to the lock body
- The R (key retaining) version holds the key when the lock is open, the NR (non key retaining) version allows the key to be removed

## TECHNOLOGY



## TEST SEALS



1) only for R-versions 2) 34358

Ref. No.	EAN 4003318	a mm	b mm	c mm	d mm	e mm	Weight g	Box Qty
4750S NR BK PRO AMPARO	89676 7	75	100	70	56	106	700	12
4750S NR BK OE	82611 5	75	100	70	56	106	700	12
4750S R BK PRO AMPARO	89677 4	75	100	70	56	106	700	12
4750S R BK OE	82612 2	75	100	70	56	106	700	12
4750SL NR BK PRO AMPARO	89678 1	75	100	86	56	106	700	12
4750SL NR BK OE	83573 5	75	100	86	56	106	700	12
4750SL R BK PRO AMPARO	89679 8	75	100	86	56	106	700	12
4750SL R BK OE	83574 2	75	100	86	56	106	700	12
Bracket SH	37552 1						56	6
Mounting straps	56240 2						48	6

Frame locks and  
battery locks

# 4650X / XL

## SECURITY LEVEL



## FEATURES



SH



Mounting straps



## TECHNICAL DATA

- 8.5 mm steel shackle
- The case, the shackle as well as supporting elements of the locking mechanism are made of specially hardened steel
- Extreme large aperture for extra wide tires
- Closing mechanism for easy attachment of accessory to the lock body
- The R (key retaining) version holds the key when the lock is open, the NR (non key retaining) version allows taking the key out of the cylinder

## TECHNOLOGY



## TEST SEALS



1) only for R-versions 2) 35482

Ref. No.	EAN 4003318	a mm	b mm	c mm	d mm	e mm	Weight g	Box Qty
4650X NR BK OE	86730 9	94	115	82	72	121	750	12
4650X R BK OE	86731 6	94	115	82	72	121	750	12
4650XL NR BK OE	86732 3	94	115	101	72	121	750	12
4650XL R BK OE	86733 0	94	115	101	72	121	750	12
Bracket SH	37552 1						56	6
Mounting straps	56240 2						48	6



# 4650S / SL



### SECURITY LEVEL



### FEATURES



SH



Mounting straps

### TECHNICAL DATA

- 8.5 mm steel shackle
- The case, the shackle as well as supporting elements of the locking mechanism are made of proprietary, specially hardened steel alloys
- Closing mechanism for easy attachment of accessory to the lock body
- The R (key retaining) version holds the key when the lock is open, the NR (non key retaining) version allows the key to be removed

### TECHNOLOGY



### TEST SEALS



1) only for R-versions 2) 34358

Frame locks and battery locks

Ref. No.	EAN 4003318	a mm	b mm	c mm	d mm	e mm	Weight g	Box Qty
4650S NR BK OE	82609 2	80	100	70	60	108,4	652	20
4650S R BK OE	82610 8	80	100	70	60	108,4	652	20
4650SL NR BK OE	83575 9	80	100	86	60	108,4	652	20
4650SL R BK OE	83576 6	80	100	86	60	108,4	652	20
Bracket SH	37552 1						56	6
Mounting straps	56240 2						48	6

# PRO TECTIC™ 4960

## SECURITY LEVEL



## FEATURES



SH



Mounting straps



## TECHNICAL DATA

- 8.5 mm thick locking shackle
- The shackle, the case as well as supporting elements of the locking mechanism are made of specially hardened steel
- Accessories can easily be fitted to the locking mechanism on the lock housing
- Accessory loop chains and cables can be plugged into the lock housing

## TECHNOLOGY



Ref. No.	EAN 4003318	a mm	b mm	c mm	d mm	e mm	Weight g	Box Qty
4960 NR black	11260 7	76	96	69	57	107,9	520	6
4960 NR black OE	11270 6	76	96	69	57	107,9	520	18
4960 NR black + 6KS/85 & ST5850	11263 8	76	96	69	57	107,9	520	3
Bracket SH	37552 1						56	6
Mounting straps	56240 2						48	6

# TECTIC™ 496



## SECURITY LEVEL



## FEATURES



SH



Mounting straps

## TECHNICAL DATA

- 8.5 mm thick locking shackle
- The shackle, the case as well as supporting elements of the locking mechanism are made of specially hardened steel
- The R (key retaining) version holds the key when the lock is open, the NR (non key retaining) version allows taking the key out of the cylinder

## TECHNOLOGY



Ref. No.	EAN 4003318	a mm	b mm	c mm	d mm	e mm	Weight g	Box Qty
496 NR black	11258 4	78	96	69	59	110	450	6
496 NR black OE	11269 0	78	96	69	59	110	450	24
496 R black OE	19457 3	78	96	69	59	110	450	24
Bracket SH	37552 1						56	6
Mounting straps	56240 2						48	6

## ADAPTOR CHAIN

### VERSIONS





ST5950



### TECHNICAL DATA

- 6 and 8 mm thick, square chain made of hardened steel
- Separate locking of the shackle is not necessary
- Opens up a lot of opportunities for locking the bicycle on to a fixed object
- Suitable for use with frame locks 4960, 5850, 5650, 5750 and 5950



Ref. No.	EAN 4003318	 mm	 cm	Weight g	Carrier	Box Qty
ACH 6KS/85 BK	11267 6	6	85	760		6
ACH 6KS/100 BK	18618 9	6	100	860		6
ACH 6KS/130 BK	01777 3	6	130	1140		6
ACH 8KS/85 BK	80782 4	8	85	1190		6
ACH 8KS/100 BK	80783 1	8	100	1400		6
ACH 6KS 85 BK + ST5950	82064 9	6	85	840	bag incl.	6
ACH 6KS 100 BK + ST5950	80785 5	6	100	1130	bag incl.	6
ACH 8KS 85 BK + ST5950	80784 8	8	85	1270	bag incl.	6

## ADAPTOR CABLE



### TECHNICAL DATA

- 12 mm thick, high-quality steel cable
- Opens up a lot of opportunities for locking the bicycle on to a fixed object
- Suitable for use with frame locks 4960, 5850, 5650, 5750 and 5950

Ref. No.	EAN 4003318	 mm	 cm	Weight g	Carrier	Box Qty
ACL 12/100 BK	18243 3	12	100	416		6

# IVYTEX ADAPTOR CHAIN

## VERSIONS



crossing grey



sparkling orange



ST5950



## TECHNICAL DATA

- Adaptor chain with IvyTex protection
- Square profile chain made of proprietary, hardened steel alloy
- Durable synthetic IvyTex fibre sleeve helps resistance to cutting attacks
- Hydrophobic IvyTex sleeve repels dirt and moisture
- 6 and 8 mm thick, square profile chain made of hardened steel
- Fabric wrapping of the loop ring to protect against paint damage
- Separate locking of the shackle is not necessary
- Opens up a lot of opportunities for locking the bicycle on to a fixed object
- Suitable for various ABUS Frame locks and the Alarmbox 2.0

Ref. No.	EAN 4003318	mm	cm	Weight g	Carrier	Box Qty
ACH IVY 6KS/85 black	68457 9	6	85	760		6
ACH IVY 6KS/85 crossing grey	68456 2	6	85	760		6
ACH IVY 6KS/85 sparkling orange	68458 6	6	85	760		6
ACH IVY 6KS/100 black	68460 9	6	100	860		6
ACH IVY 6KS/100 black +ST5950	69055 6	6	100	940	ST5950	6
ACH IVY 6KS/100 crossing grey	68459 3	6	100	860		6
ACH IVY 6KS/100 sparkling orange	68461 6	6	100	860		6
ACH IVY 6KS/130 black	68463 0	6	130	1140		6
ACH IVY 6KS/130 crossing grey	68462 3	6	130	1140		6
ACH IVY 6KS/130 sparkling orange	68464 7	6	130	1140		6
ACH IVY 8KS/100 black	68466 1	8	100	1400		6
ACH IVY 8KS/100 crossing grey	68465 4	8	100	1400		6
ACH IVY 8KS/100 sparkling orange	68467 8	8	100	1400		6

# SERVICE PRICELIST

## FRAME LOCKS

### 5755L

67868	5755L R BK OE + BLO BOS DT2 XPlus
67448	5755L NR BK OE + BLO BOS RT2 XPlus
67164	5755L R BK OE + BLO BOS IT2.1 XPlus
66593	5755L NR BK OE + BLO BOS IT2.1 XPlus
67163	5755L NR BK OE + BLO BOS IT3 XPlus
67160	5755L NR BK OE + BLO BOS DT2 XPlus
67869	5755L NR BK OE + BLO BOS DT2 XPlus 2x
67449	5755L R BK OE + BLO BOS RT2 XPlus
67165	5755L R BK OE + BLO BOS IT3 XPlus
67146	5755L NR BK OE + BLO BOS IT2.1 XPlus 2x
67450	5755L NR BK OE + BLO BOS IT2.1 + RT2 XPlus
67166	5755L NR BK OE + BLO BOS IT2.1 + DT2 XPlus
67870	5755L R BK OE + BLO BOS DT2 XPlus 2x
67451	5755L R BK OE + BLO BOS IT2.1 + RT2 XPlus
67148	5755L R BK OE + BLO BOS IT2.1 XPlus 2x
67167	5755L R BK OE + BLO BOS IT2.1 + DT2 XPlus
67152	5755L R BK OE + BLO RIE IT1 XPlus 2x
67154	5755L NR BK OE + BLO RIE IT1 XPlus 2x
67153	5755L NR BK OE + BLO RIE IT1 XPlus 2x + GLO UNI
67155	5755L R BK OE + BLO RIE IT1 XPlus 2x + GLO UNI
67057	5755L R BK OE XPlus BLO SCO IT2
67161	5755L NR BK OE + BLO UNI IT1 XPlus



### 4750

89680	4750XL NR BK OE + BLO BOS IT2.1 T82
89681	4750XL R BK OE + BLO BOS IT2.1 T82
63351	4750XL NR BK OE + BLO BOS IT2.1 2 x
67876	4750XL NR BK OE + BLO BOS IT2.1+BLO BOS DT2 T83
62580	4750XL NR BK OE + BLO BOS IT2.1+BLO BOS DT2
89682	4750XL NR BK OE + BLO BOS DT2 T82
64414	4750XL R BK OE + BLO BOS DT2 + BLO BAF 15,7 T82
89684	4750XL NR BK OE + BLO SHI IT2 T82 ASY
89685	4750XL R BK OE + BLO SHI IT2 T82
40661	4750SL R BK OE + BLO BOS IT2.1+DT2
68735	4750X NR BK OE + BLO BOS IT3 T82
64479	4750X NR BK OE + BLO BOS IT2.1 T82
64477	4750X R BK OE + BLO BOS IT2.1 T82
63271	4750L R BK OE + BLO BOS IT2.1 T82
88867	4750SL NR BK OE + BLO BOS IT2.1
64481	4750X R BK OE + BLO BOS DT2 T82
64483	4750X NR BK OE + BLO BOS DT2 T82
88975	4750L R BK OE + BLO BOS DT2
62579	4750L NR BK OE + BLO BOS DT2
67056	4750L R BK OE + BLO BOS RT2 T82
62577	4750L NR BK OE + BLO SHI IT2 ASY
62578	4750L NR BK OE + BLO SHI DT1 T82
64310	4750L NR BK OE + BLO BOS DT2 T83
64203	4750L NR BK OE + BLO DAF UNI T83
86021	4750 R BK OE + BLO BOS IT2.1



### 5750

85789	5750L NR BK OE BLO TRE IT1
-------	----------------------------



**4750**

86632	4750S R BK OE + BLO BOS RT2
86633	4750S R BK OE + BLO BOS DT2
62573	4750S NR BK OE + BLO BOS RT2 T82
62572	4750S NR BK OE + BLO BOS IT2.1 T82
62571	4750S NR BK OE + BLO BOS DT2 T82
64311	4750S NR BK OE + BLO BOS DT2 T83
62576	4750S NR BK OE + BLO SHI IT2 ASY
62574	4750S NR BK OE + BLO SHI DT1
64393	4750S R BK OE + BLO HUY 13,3 T82
68733	4750S R BK OE + BLO PHY 11.3 T82

**4650**

40147	4650XL NR BK OE + BLO SHI IT2 T82 ASY
40148	4650XL R BK OE + BLO SHI IT2 T82 ASY
68019	4650X R BK OE + BLO BOS IT3 T82
87966	4650SL R BK OE + BLO TRE IT1
87967	4650SL NR BK OE + BLO TRE IT1
68438	4650SL R BK OE + BLO BOS DT2 T82
68437	4650SL R BK OE + BLO BOS DT2 + DT2 T82
64440	4650S R BK OE + BLO DAF UNI T82
69090	4650SL R BK OE + BLO DAF UNI T82

**4960**

83178	4960 NR BK OE + BLO BOS IT2.1
39637	4960 NR BK OE + BLO BOS DT2
39636	4960 NR BK OE + BLO BOS RT2

**4960**

61511	4960 NR BK OE + BLO DAF UNI T82
86649	4960 NR BK OE + BLO SHI IT2
36770	4960 NR BK OE + BLO SHI DT1 T82
36769	4960 NR BK OE + BLO SHI RT1

**FOLDING LOCKS****6500**

90244	6500K/90 BK OE SH + BLO BOS IT2.1 XPIus
90245	6500K/90 BK OE SH + BLO BOS RT2 XPIus
90246	6500K/90 BK OE SH + BLO BOS DT2 XPIus

**6000K**

67140	6000K/90 BK OE SH + BLO BOS IT2.1 XPIus
67142	6000K/90 BK OE SH + BLO BOS IT2.1 XPIus 2x
68637	6000K/90 BK OE SH + BLO BOS DT2 XPIus

**6015**

89544	6015/90 BK OE SH ZEG + BLO ZEG IT5 PLUS
39904	6015/120 BK OE SH + BLO ZEG IT3 PLUS



**Bianchi**

67973 BLO BIA IT1 XPlus

---

63893 BLO BIA IT1 PLUS

**Bosch**

64444 BLO CUB IT1 XPlus

---

64288 BLO BOS IT2.1 XPlus

---

64293 BLO CUB IT1.B3 XPlus

---

64131 BLO BOS IT3 XPlus

---

64445 BLO CUB IT2 XPlus

---

67824 BLO KTM IT1 XPlus

---

67058 BLO SCO IT2 XPlus

---

64294 BLO CUB IT2.B3 XPlus

---

64290 BLO BOS DT2 XPlus

---

71204 BLO BOS IT2.1 PLUS

---

78078 BLO CUB IT1 PLUS

---

80424 BLO TRE IT1 PLUS

---

33261 BLO BOS DT2 PLUS

---

40729 BLO CUB IT2 PLUS

---

33262 BLO BOS RT2 PLUS

---

79120 BLO ZEG IT3 PLUS

---

87964 BLO ZEG IT5 PLUS

---

71203 BLO BOS IT2.1 T82

**Bosch**

06074 BLO BOS DT2 T82

---

87965 BLO TRE IT1 T82

---

06075 BLO BOS RT2 T82

---

66651 BLO BOS IT3 T82

---

40854 BLO BOS IT2.1 T82 ASY

---

72901 BLO BOS DT2 T82 ASY

---

81585 BLO BOS DT2 T83

**Brose**

40639 BLO HAR IT1 XPlus

---

81686 BLO SPE IT2 PLUS

---

79119 BLO ZEG IT2 PLUS

---

39407 BLO BRO IT1 LC T83

**Darfon**

83441 BLO DAF UNI T82

**Fazua**

84233 BLO FAZ IT1 PLUS

**Giant**

83624 BLO GIA IT1 M T82

---

83623 BLO GIA IT1 F



**Panasonic**

64289 BLO PAN IT1 XPlus

70743 BLO PAN IT1 PLUS

58776 BLO PAN DT1 T82

**Shimano**

64291 BLO SHI IT2 XPlus

80476 BLO SHI DT1 PLUS

86044 BLO SHI IT2 PLUS

37196 BLO SHI DT1 T82

36668 BLO SHI RT1 T82

76539 BLO SHI IT1 T82

86106 BLO SHI IT2 T82 ASY

**Yamaha**

80910 BLO YAM DT1 PLUS

**ZEG**

68076 BLO ZEG IT4 XPlus

70496 BLO ZEG IT1 T82

**Others**

64292 BLO UNI IT1 XPlus

**R: key retaining**

The key is left in the lock when it is open.

**NR: key non retaining**

The key can be removed when the lock is open.

**IT: Intube****DT: Downtube****RT: Ractube**

**SPECIAL SECURITY**



**ALARMBOX**

**2.0**



black

Page 124

**ALARMBOX**

**RC**



black

Page 125

**WCH**



black

Page 126

**GRANIT™**

**WBA 100**



black

Page 128

**GRANIT™**

**WBA 75**



black

Page 128

**WBA 60**



black

Page 129

**WA 50**



black

Page 129

**SPORTFLEX**

**2504**



black

Page 130

**COMBILoop**

**205**



black

Page 132

**COMBIFLEX™**



black

Page 132

**COBRA™**



black

Page 133

**1850**



black

Page 133

**FIRE STOP SPRAY**

**AFS625**



Page 134

**PS 88**



Page 134

**KEYGARAGE™**

**787 BIG LED**



Page 135

**KEYGARAGE™**

**787 BIG**



Page 135

**KEYGARAGE™**

**787 LED**



Page 136

**KEYGARAGE™**

**787**



Page 136

**KEYGARAGE™  
797 LED**



Page 137

**KEYGARAGE™  
797**



Page 137

**KEYGARAGE™  
767**



Page 138

**145**



blue

Page 139



yellow

Page 139

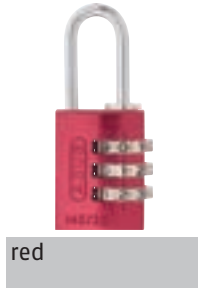

red

Page 139



silver

Page 139



orange

Page 139



purple

Page 139



green

Page 139



titanium

Page 139

**TITANIUM™  
64**



Page 140

**70 & 70IB**



70

Page 141



70IB

Page 141

**DISKUS®  
24IB**



Page 141

**DISKUS  
20**



Page 142

**147TSA**



Page 142



# ALARMBOX 2.0

## VERSIONS



Alarmbox 2.0 BK + ACH 6KS/100



Alarmbox 2.0 BK + ACL 12/100

## TECHNICAL DATA

- Alarm function with min. 100 dB for 15 seconds, thereafter automatic re-arming
- 3D position detection senses impacts and movements
- Intelligent alarm – the lock gives a short warning signal after unintentional movement
- Incl. CR2 battery
- Secure fitting to bikes or any other round tube using silicone coated metal straps
- Compatible with ABUS ACH adapter chains and ACL adapter cables
- Available with 6mm/100cm ACH chain or as standalone unit

## TECHNOLOGY



Ref. No.	EAN 4003318	Weight g	Carrier	Box Qty
Alarmbox 2.0 BK	61482 8	430		4
Alarmbox 2.0 BK + ACH 6KS/100	61488 0	1271		4
Alarmbox 2.0 BK + ACL 12/100	61489 7	747		4

# ALARMBOX RC

## VERSIONS



RC



Alarmbox RC  
Top view



## TECHNICAL DATA

- Alarmbox with remote control
- Alarm function with min. 100 dB for 15 seconds, thereafter automatic re-arming
- 3D position detection senses impacts and movements
- Intelligent alarm – the lock gives a short warning signal after unintentional movement
- Convenient activation using remote
- Uses CR2 (alarmbox) and CR2032 (remote) battery (included)
- Wide range of applications and uses
- Super lightweight
- Multiple fitting options

## TECHNOLOGY



Ref. No.	EAN 4003318	Weight g	Carrier	Box Qty
Alarmbox RC SingleSet	61487 3	78		1
Alarmbox RC TwinSet	69058 7	2 x 78		1
Alarmbox RC Box only	69059 4	62		1
Alarmbox RC RC only	69060 0	16		1

Special security



### WCH

The new wall chain anchor neatly integrates anchor and chain into a high-security system - safer, more cost-effective and easier to use. On request, we can build a WCH to match your existing XPlus key code. WCH chains are available in different lengths to suit your needs. And if your bike collection grows, you can even link several Wall chains together.

Ref. No.	EAN 4003318	Diameter	Length	Carrier	Box Qty
WCH + ACH 9KS/110	69061 7	9	110		1
WCH + ACH 9KS/110 Twin Chain	69063 1	9	110		1
WCH + ACH 9KS/130	69062 4	9	130		1



# WCH

★  
NEW

## VERSIONS



WCH + ACH 9KS/110  
Twin Chain



WCH + ACH 9KS/130



## SECURITY LEVEL



## TECHNOLOGY



## TECHNICAL DATA

- Wall anchor with integrated chain
- Chain and housing made of proprietary, specially hardened steel alloys
- The wall anchor is firmly anchored in the wall with high-security special wall plugs
- Supplied with highest quality, high security Fischer™ fitting hardware
- Only designed for wall installation
- Chain and housing made of proprietary, specially hardened steel alloys
- Textile sleeve to protect bicycle finish
- Chains available in different lengths and can be swapped
- Daisy-chain multiple Wall chains
- ABUS XPlus cylinder for exceptional protection against manipulation

Special security

# GRANIT™ WBA 100

## SECURITY LEVEL



Security Level  
Motorbike

## FEATURES



## OPERATION AND USE

- The anchor can be used to secure two-wheeled vehicles in garages, cellars and houses
- The WBA 100 can be fixed to the ground or the wall. When combined with an ABUS lock, it offers the highest level of security

## TECHNICAL DATA

- 16 mm thick shackle made of hardened special steel for maximum resistance
- Incl. mounting accessories

## TEST SEALS



Ref. No.

EAN  
4003318



mm



mm



mm



mm



mm

Weight  
g

1880

Box  
Qty

1

WBA 100 GRANIT

27161 8

160

165

16

65

77

1880

1

# GRANIT™ WBA 75

## SECURITY LEVEL



## FEATURES



## OPERATION AND USE

- The anchor can be used to secure two-wheeled vehicles in garages, cellars and houses
- The WBA 75 can be attached to the floor or the wall with the supplied mounting accessories. When combined with an ABUS lock, it offers the highest level of security

## TECHNICAL DATA

- 14 mm thick shackle made of hardened special steel for maximum resistance
- Incl. mounting accessories

## TEST SEALS



Ref. No.

EAN  
4003318



mm



mm



mm



mm



mm

Weight  
g

850

Box  
Qty

1

WBA 75 GRANIT B/SB

78606 8

135

98

14

65

66

850

1

# WBA 60

## SECURITY LEVEL



## FEATURES



## OPERATION AND USE

- The anchor can be used to secure two-wheeled vehicles in garages, cellars and houses
- The WBA 60 can be mounted either on the floor or on the wall using the mounting accessories supplied. In combination with an ABUS lock it offers the highest security

## TECHNICAL DATA

- 10 mm thick shackle made of hardened special steel for maximum resistance
- Incl. mounting accessories

## TEST SEALS



Ref. No.

EAN  
4003318



118



80



10



52



55

Weight  
g

450

Box  
Qty

1

WBA 60 B/SB

# WA 50

## SECURITY LEVEL



## FEATURES



## OPERATION AND USE

- The anchor can be used to secure two-wheeled vehicles in garages, cellars and houses
- The WA 50 is designed for wall installation. In combination with an ABUS lock, it offers a high level of security

## TECHNICAL DATA

- Strong wall anchor made of hardened steel
- Incl. mounting accessories

Ref. No.

EAN  
4003318



110



80



38



38

Weight  
g

786

Box  
Qty

1

WA 50

04294 2



#### SportFlex 2504

With the SportFlex you always have a lock with you as a performance-oriented rider - mounted between the frame and bottle cage. The SportFlex deploys a flexible 2.4 mm cable that is 90 cm long - perfect for securing your road bike to available objects such as bike racks or lanterns. The extendable cable lock is compatible with all carbon frames. Thanks to its practical numerical code lock, you are no longer required to carry a key. Knowing that your high-quality bike is protected from opportunistic thieves, you can be more relaxed during short stops.

Ref. No.	EAN 4003318	Diameter mm	Length cm	Weight g	Carrier	Box Qty
2504/90	69054 9	2,4	90	100		1

# SPORTFLEX 2504

NEW



## TECHNOLOGY



## TECHNICAL DATA

- Integrated cable lock for performance bikes
- Installation on bottle cage fixing points
- Low 20 mm profile allows fitting underneath existing bottle cage
- Automatically retracting cable
- Individually settable code
- Ideal for protecting against opportunist theft

Special security

# COMBILoop 205

## SECURITY LEVEL



## TECHNICAL DATA

- 5 mm thick steel cable
- Synthetic coating to prevent damage to the bicycle's paintwork
- Automatic locking at insertion of the locking bolt
- Individually settable code

## TECHNOLOGY



Ref. No.	EAN 4003318	mm	cm	Weight g	Carrier	Box Qty
205/200 black	52523 0	5	200	180		12

# COMBIFLEX™

## FEATURES



## TECHNICAL DATA

- Super light and compact lock for quick stops whilst riding
- Automatically retracting cable
- Individually settable code
- 3 cable lengths/thickness to suit your locking needs
- Case in attractive mobile phone format

## TECHNOLOGY





Ref. No.	EAN 4003318	mm	cm	Weight g	Carrier	Box Qty
2501/65	72499 2	1,6	65	54		3
2502/85	72500 5	2	85	80		3
2503/120	72501 2	2,5	120	89		3
2503/120 +UCH 2503	66310 9	2,5	120	100	UCH 2503	1



## TECHNICAL DATA

- High quality steel cable with two loop ends
- Synthetic coating to prevent damage to the bicycle's paintwork
- Variety of lengths and thicknesses available to suit your needs



Ref. No.	EAN 4003318	 mm	 cm	Weight g	Carrier	Box Qty
Cobra 5/75 black	37106 6	5	75	75		24
Cobra 8/200 black	25718 6	8	200	280		24
Cobra 8/250 black	27390 2	8	250	395		16
Cobra 10/140 black	37107 3	10	140	310		30
Cobra 10/200 black	11167 9	10	200	400		28
Cobra 10/220 black	37108 0	10	220	420		24
Cobra 10/300 black	59930 9	10	300	560		21
Cobra 10/500 black	20780 8	10	500	850		15
Cobra 10/1000 black	20781 5	10	1000	1580		9
Cobra 12/120 black	25719 3	12	120	380		15
Cobra 12/180 black	27391 9	12	180	490		15

## 1850



## TECHNICAL DATA

- High quality steel cable with two loop ends
- Synthetic coating to prevent damage to the bicycle's paintwork

Ref. No.	EAN 4003318	 mm	 cm	Weight g	Carrier	Box Qty
1850/185	12752 6	8	185	280		18

## FIRE STOP SPRAY AFS625



### TECHNICAL DATA

- 625 ml highly effective foam extinguishing agent
- Fire stop spray can be used universally, whether at home, in the car, or at sea.
- Maintenance-free unlike fire extinguishers
- Easy to use – just like a conventional spray can
- Spraying range (max. distance between source of fire and user) up to 4 m
- Spray time approx. 25 seconds
- Weight: approx. 900 g gross

Ref. No.	EAN 4003318	Weight g	Box Qty
Fire stop spray AFS625	85727 0	900	6

## PS88



125 ml



50 ml

### TECHNICAL DATA

- Free from chlorine, fluorine (CKW/FCKW), PCB, lead and other contaminants
- Non-greasy special lubricant spray

Ref. No.	EAN 4003318	Dimensions	Version	Box Qty
VK PS88 Spray DK/EN	82931 4	14 / 18 / 31 cm	12x125ml	1
VK PS88 Spray 50ml GB	31942 6	15 / 21 / 29 cm	24x50ml	1
PS88 Spray 125ml DK/EN	82231 5			1
PS88 EN	35421 2			1



## KEYGARAGE™ 787 BIG LED



LED lighting

### TECHNICAL DATA

- Ideal protected storage of keys and other valuables for authorised persons
- Quick and easy access for frequently changing groups of persons (craftsmen, service, holiday guests, apartment buildings, car rentals)
- Defining access by setting and passing on the code
- For wall mounting indoors and in protected outdoor areas
- Solid metal housing
- Locking cover made of zinc die-cast
- 4-digit individually settable code
- Illuminated dials for a better legibility in dark conditions
- LEDs light up ca. 30 seconds
- Customary coin cell battery (CR2032) can be easily replaced, durability of battery when used 1x per day approximately 2 years
- Protected cover with sliding mechanism
- For wall mounting with screws
- Can hold up to 20 keys or 14 code cards
- Easily removable clip-in hooks guarantee consumer's comfort
- Outer dimensions of housing: 84 x 119 x 42

### TECHNOLOGY



Ref. No.

EAN  
4003318

  
mm

  
mm

  
mm

Weight  
g

Box  
Qty

KeyGarage™ 787 BIG

08492 8

83,5

62

120

850

1

## KEYGARAGE™ 787 BIG



### TECHNICAL DATA

- Ideal protected storage of keys and other valuables for authorised persons
- Quick and easy access for frequently changing groups of persons (craftsmen, service, holiday guests, apartment buildings, car rentals)
- Defining access by setting and passing on the code
- For wall fixing indoors and in protected outdoor areas
- Storage of a complete bunch of key now possible because of larger space and removable hook
- Very large solid metal housing and extra large storage compartment
- Locking cover made from zinc die-cast
- Individually resettable code (4-digit)
- Protected cover with sliding mechanism
- For wall mounting with screws
- Holds up to 30 cards or 50 keys
- Easily removable clip-in hooks guarantee consumer's comfort
- Flat inner mechanism makes a larger storage space possible
- Outer dimensions of housing: 84 x 119 x 62

### TECHNOLOGY



Ref. No.

EAN  
4003318

  
mm

  
mm

  
mm

Weight  
g

Box  
Qty

787 BIG LED B/Wall mounting KeyGarage

83856 9

84

62

120

880

1

## KEYGARAGE™ 787 LED



LED lighting

### TECHNICAL DATA

- Ideal protected storage of keys and other valuables for authorised persons
- Quick and easy access for frequently changing groups of persons (craftsmen, service, holiday guests, apartment buildings, car rentals)
- Defining access by setting and passing on the code
- For wall mounting indoors and in protected outdoor areas
- Solid metal housing
- Locking cover made of zinc die-cast
- 4-digit individually settable code
- Illuminated dials for a better legibility in dark conditions
- LEDs light up ca. 30 seconds
- Customary coin cell battery (CR2032) can be easily replaced, durability of battery when used 1x per day approximately 2 years
- Protected cover with sliding mechanism
- For wall mounting with screws
- Can hold up to 20 keys or 14 code cards
- Easily removable clip-in hooks guarantee consumer's comfort
- Outer dimensions of housing: 84 x 119 x 42

### TECHNOLOGY



Ref. No.

EAN  
4003318



Weight  
g

Box  
Qty

787 KeyGarage B

46331 0

80

45

120

662

1

## KEYGARAGE™ 787



### TECHNICAL DATA

- Ideal protected storage of keys and other valuables for authorised persons
- Quick and easy access for frequently changing groups of persons (craftsmen, service, holiday guests, apartment buildings, car rentals)
- Defining access by setting and passing on the code
- For wall mounting indoors and in protected outdoor areas
- Solid metal housing
- Locking cover made of zinc die-cast
- 4-digit individually settable code
- Protected cover with sliding mechanism
- For wall mounting with screws
- Can hold up to 20 keys or 14 code cards
- Outer dimensions of housing: 84 x 119 x 42
- Easily removable clip-in hooks guarantee consumer's comfort

### TECHNOLOGY



Ref. No.

EAN  
4003318



Weight  
g

Box  
Qty

787 LED B/Wall mounting KeyGarage

83854 5

84

44

180

740

1

# KEYGARAGE™ 797 LED



LED lighting





Adapter

## TECHNOLOGY



## TECHNICAL DATA

- Ideal protected storage of keys and other valuables for authorised persons
- Quick and easy access for frequently changing groups of persons (craftsmen, service, holiday guests, apartment buildings, car rentals)
- Defining access by setting and passing on the code
- Fixing with shackle, e.g. on a door knob of gates and doors
- Solid metal housing
- Locking cover made of zinc die-cast
- 4-digit individually settable code 4-digit
- Illuminated dials for a better legibility in dark conditions
- LEDs light up ca. 30 seconds
- Customary coin cell battery (CR2032) can be easily replaced, durability of battery when used 1x per day approximately 2 years
- Protected cover with sliding mechanism
- Fixing with shackle, e.g. on a door knob of gates and doors
- Can hold up to 20 keys or 14 code cards
- Outer dimensions of housing: 84 x 119 x 44
- Housing and shackle plastic coated (protected door from scratching)

Ref. No.	EAN 4003318	 mm	 mm	 mm	Weight g	Box Qty
797 KeyGarage B	46330 3	85	45	180	770	1
Adapter for 797 KeyGarage	56321 8				125	1

# KEYGARAGE™ 797





Adapter

## TECHNOLOGY



## TECHNICAL DATA

- Ideal protected storage of keys and other valuables for authorised persons
- Quick and easy access for frequently changing groups of persons (craftsmen, service, holiday guests, apartment buildings, car rentals)
- Defining access by setting and passing on the code
- Fixing with shackle, e.g. on a door knob of gates and doors
- Solid metal housing
- Locking cover made of zinc die-cast
- 4-digit individually settable code
- Protected cover with sliding mechanism
- Fixing with shackle, e.g. on a door knob of gates and doors
- Can hold up to 20 keys or 14 code cards
- Outer dimensions of housing: 84 x 119 x 44
- Housing and shackle plastic coated (protected door from scratching)

Ref. No.	EAN 4003318	 mm	 mm	 mm	Weight g	Box Qty
797 LED B/with shackle KeyGarage	83855 2	84	44	120	843	1
Adapter for 797 KeyGarage	56321 8				125	1

# KEYGARAGE™ 767



## TECHNICAL DATA

- Ideal protected storage of keys and other valuables for authorised persons
- Quick and easy access for frequently changing groups of persons (craftsmen, service, holiday guests, apartment buildings, car rentals)
- Defining access by setting and passing on the code
- For wall fixing indoors and in protected outdoor areas
- Solid metal housing
- Locking cover made from zinc die-cast
- Code up to 10 digits individually resettable (the sequence of the code is irrelevant)
- Code needs to be entered in order to close the locking cover
- Plastic cover to protect against dust, dirt, etc.
- For wall fixing with screws
- Holds up to 17 cards or 20 keys
- Outer dimensions of housing: 84 x 119 x 47

## TECHNOLOGY



Ref. No.

EAN  
4003318

  
mm

  
mm

  
mm

Weight  
g

Box  
Qty

767 KeyGarage PB2 B/

53507 9

80

120

45

648

1

# 145

## VERSIONS

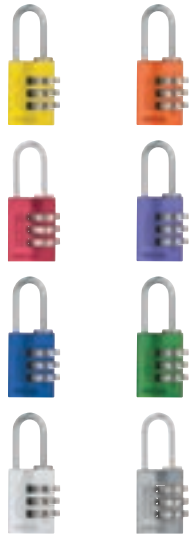

## TECHNICAL DATA

- 145/20 and 145/30: To secure valuables/goods of lesser value or at a low risk of theft
- 145/40: To secure valuables/goods of medium value or at an average risk of theft
- E.g. to secure luggage, lockers in schools and sports centres, cash boxes, jewel cases, cupboards, tool boxes, switchboards, etc.
- Solid aluminium lock body with anodized coating – corrosion resistant
- Spring loaded shackle for a better setting of the opening code
- 145/20 and 145/30: Individually resettable 3-digit code
- 145/40: Individually resettable 4-digit code
- Handy operation without key, low weight
- High value of recognition by intensive colours

Ref. No.	EAN 4003318	mm	mm	mm	mm	mm	mm	Weight g	Box Qty
145/20 yellow B/DFNLI	46552 9	22,5	9	22	3	13,5	52,5	25	6
145/20 orange B/DFNLI	46550 5	22,5	9	22	3	13,5	52,5	25	6
145/20 red B/DFNLI	46549 9	22,5	9	22	3	13,5	52,5	25	6
145/20 purple B/DFNLI	46553 6	22,5	9	22	3	13,5	52,5	25	6
145/20 blue B/DFNLI	46548 2	22,5	9	22	3	13,5	52,5	25	6
145/20 green B/DFNLI	46551 2	22,5	9	22	3	13,5	52,5	25	6
145/20 silver B/DFNLI	46554 3	22,5	9	22	3	13,5	52,5	25	6
145/20 titanium B/DFNLI	46556 7	22,5	9	22	3	13,5	52,5	25	6
145/20 black B/DFNLI	34609 5	22,5	9	22	3	13,5	52,5	25	6
145/30 yellow B/DFNLI	46561 1	31,5	14	26	5	15,5	65	55	6
145/30 orange B/DFNLI	46559 8	31,5	14	26	5	15,5	65	55	6
145/30 red B/DFNLI	46558 1	31,5	14	26	5	15,5	65	55	6
145/30 purple B/DFNLI	46562 8	31,5	14	26	5	15,5	65	55	6
145/30 blue B/DFNLI	46557 4	31,5	14	26	5	15,5	65	55	6
145/30 green B/DFNLI	46560 4	31,5	14	26	5	15,5	65	55	6
145/30 silver B/DFNLI	46563 5	31,5	14	26	5	15,5	65	55	6
145/30 titanium B/DFNLI	46565 9	31,5	14	26	5	15,5	65	55	6
145/30 black B/DFNLI	34610 1	31,5	14	26	5	15,5	65	55	6
145/40 yellow B/DFNLI	49534 2	41,5	21,5	26	6	17,5	77	110	6
145/40 orange B/DFNLI	49526 7	41,5	21,5	26	6	17,5	77	110	6
145/40 red B/DFNLI	48830 6	41,5	21,5	26	6	17,5	77	110	6
145/40 blue B/DFNLI	49522 9	41,5	21,5	26	6	17,5	77	110	6
145/40 green B/DFNLI	49530 4	41,5	21,5	26	6	17,5	77	110	6
145/40 silver B/DFNLI	49542 7	41,5	21,5	26	6	17,5	77	110	6
145/40 titanium B/DFNLI	49550 2	41,5	21,5	26	6	17,5	77	110	6







# 64 TITALIUM™

## VERSIONS



## TECHNICAL DATA

- Security for items/goods of medium value or where there is an average risk of theft
- For securing e.g. chains, doors, gates, cupboards, lockers, tool boxes, cellar windows or sheds
- Solid lock body made from TITALIUM™ special aluminium
- Hardened steel shackle with NANO PRedECT™ coating for extreme corrosion resistance
- 64TI/50HB60-150: Removable and adjustable shackle from 60 mm to 150 mm
- Paracentric key profile for increased protection against manipulation
- Double bolted shackle
- Chrome-plated cylinder plug for additional corrosion protection
- Tulip-shaped key head

Ref. No.	EAN 4003318	 mm	 mm	 mm	 mm	 mm	 mm	Weight g	Box Qty
64TI/20 B/DFNLI	56384 3	20	9,5	11,5	3,5	10,5	34	21	6
64TI/25 B/DFNLI	56386 7	24,5	13	13,5	4	12	42	31	6
64TI/30 B/DFNLI	56387 4	30	16	17	5	13	50	53	12
64TI/30HB60 B/DFNLI	56388 1	30	16	60	5	13	93	65	6
64TI/35 B/DFNLI	56390 4	35	19	20	5,5	14	54	67	6
64TI/40 B/DFNLI	56391 1	40	22	23	6	15	62	87	6
64TI/40HB40 B/DFNLI	56392 8	40	22	40	6	15	79	96	3
64TI/40HB63 B/DFNLI	56393 5	40	22	63	6	15	102	107	3
64TI/45 B/DFNLI	56398 0	45	25	24	7	15	68	109	6
64TI/50 B/DFNLI	56399 7	50	28	29	8	17	77	159	6
64TI/50HB80 B/DFNLI	56400 0	50	28	80	8	17	128	199	6
64TI/50HB60-150 B/DFNLI	89490 9	50	28	60-150	8	17	77	159	6
64TI/50HB60-150 gl.	63308 9	50	28	60-150	8	17	77	159	6
64TI/60 B/DFNLI	56401 7	60	34	35	10	19	91	236	4

## 70 & 70IB



70/45HB63









70IB/45



70IB/50



70IB/45HB63

Ref. No.	EAN 4003318	 mm	 mm	 mm	 mm	 mm	 mm	Weight g	Box Qty
70/45 B/DFNLI	32130 6	49	20	24	8	28	68	164	6
70/45HB63 B/DFNLI	32131 3	49	21	63	8	28	112	210	6
70IB/45 B/DFNLI	32132 0	49	20	24	8	28	68	193	6
70IB/45HB63 B/DFNLI	35834 0	49	20	63	8	28	112	210	6
70IB/50 B/DFNLI	42733 6	55	23,5	26,5	9	31	76	217	6

### TECHNICAL DATA







- Security for items/goods of medium value or where there is an average risk of theft
- For securing chains, doors, gates, cupboards, lockers, tool boxes, cellar windows, sheds, switch boxes, etc.
- Also suitable for outdoor use
- Solid lock body made from brass
- Shackle made from hardened steel with plastic sleeve
- Sealed lock body with special protection cap and drainage channels to protect the locking mechanism from water and dirt
- Shock-absorbing plastic casing protects sensitive surfaces
- Double bolted
- Precision pin cylinder
- Paracentric key profile for increased protection against manipulation
- Inner components made from rust-free materials
- Self-locking: lock without the key by pushing down the shackle

## DISKUS® 24IB



### TECHNICAL DATA

- For the protection of larger assets and objects with a high risk of theft
- Ideal for severe weather conditions (e.g., in sea and port areas, for securing vehicles and boats in outdoor use)
- For securing trucks, doors, gates, barns, cellars, cupboards, etc.
- Lock body, inner parts and shackle made solely from stainless steel for extreme resistance to corrosion
- Cylinder cover – maximum protection against dirt and water spray (60 mm and 70 mm only)
- Nickel-plated cylinder for enhanced weather protection
- Original Diskus® design: 360° predection
- Diskus® Deep-Welding Technology – the best in break-in protection
- Precision pin cylinder
- Key retaining: locking only with the key (key cannot be removed while the lock remains open)
- Made in Germany







Ref. No.	EAN 4003318	 mm	 mm	 mm	 mm	 mm	 mm	Weight g	Box Qty
24IB/50 B/DFNLI	32123 8	51	13	8	6,5	25,5	50	143	6
24IB/60 B/DFNLI	35042 9	60	17	13	8	26	60	220	6
24IB/70 B/DFNLI	32124 5	70	20	17	10	31	70	320	6

## DISKUS® 20



### TECHNICAL DATA

- To secure valuables/goods of great value or at a very high risk of theft
- To secure e.g. warehouses, industrial sites, factory gates, containers and lorries
- Ideally used with ABUS Diskus® Hasp 140: virtually impossible to attack shackle
- Stainless steel - outside and inside
- Additional protection against sawing
- Shackle made from high quality stainless steel
- ABUS-Plus disc cylinder: highest protection against manipulation, extremely high number of key differs
- Cylinder cover – maximum protection against dirt and water spray
- Sophisticated Diskus® welded seam for highest break resistance
- Original Diskus® design: 360° protection
- Key retaining: key is needed for locking (lock retains key until locked)
- Made in Germany
- 2 keys

Ref. No.	EAN 4003318	 mm	 mm	 mm	 mm	 mm	 mm	Weight g	Box Qty
20/70	08854 4	70	20	17	10	30	70	337	1
20/80	08798 1	80	25	18	11	35	81	469	3
20/70 B/DFNLI	35023 8	70	20	17	10	30	70	337	6
20/80 B/DFNLI	35024 5	80	25	18	11	35	81	469	3

## 147TSA



### TECHNICAL DATA

- To secure valuables/goods of lower value or at a low risk of theft
- Suitable e.g. to secure luggage
- Ideal for journeys to the USA: the luggage can be opened/relocked by the US security authorities without damaging the lock
- Lock body made from plastic
- Shackle diameter 3 mm
- Individually resettable 3-digit code
- Visible red indicator at shackle: lock was opened by TSA. To reset red indicator open lock and turn shackle by 360°

### TECHNOLOGY



Ref. No.	EAN 4003318	 mm	 mm	 mm	 mm	 mm	 mm	Weight g	Box Qty
147TSA/30 B	53093 7	33	13	20	3	14	60	28	12





**BRACKETS AND BAGS**





**SH B**  
black  
Page 148



**USKF**  
black  
Page 150



**EAZY KF™**  
black  
Page 150

**USH 540 / 470 / 460 /  
420 / 410 / 440A**



black  
Page 150



**GH 50**  
black  
Page 151



**UGH 02**  
black  
Page 151

**SHACKLE CLAMP**



black  
Page 151

**BRACKET SADDLEFIX SH SF**



black  
Page 152

**BRACKET SH 6500A  
SMARTX™**



black  
Page 152

**BRACKET SH FL**



black  
Page 152

**BRACKET SH 6500/85**



black  
Page 153

**BRACKET SH 6500K/90**



black  
Page 153

**BRACKET SH 6500/110**



black  
Page 153

**BRACKET SH 6000**



black  
Page 154

**BRACKET SH 6000  
BORDO™ BIG**



black  
Page 154

**BRACKET SH 5700/80**



black  
Page 154

**BRACKET SH 5700K/100**



black  
Page 155

**BRACKET SH 6055  
BORDO™ LITE**



black  
Page 155

**BRACKET SELLE ROYAL**



black

Page 155

**BAG ST 6500  
BORDO XPLUS™**



black

Page 156

**BAG ST 6000  
BORDO XPLUS™**



black

Page 156

**BAG ST 6000  
BORDO™ BIG**



black

Page 156

**BAG ST 5700  
UGRIP BORDO™**



black

Page 157

**BAG ST 6050  
BORDO™ LITE**



black

Page 157

**IVERA RBU**



black

Page 157

**CHAIN BAG  
ST 2012**



black

Page 158

**ST  
5850/5650/4960**

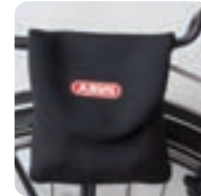

black

Page 158

**BRACKET  
SNAP CAGE**



black

Page 158

**SCLL**



black

Page 159

**BRACKET SELLE ROYAL**



black

Page 159

**BRACKET  
FIDLOCK FL**



black

Page 159

**BRACKET  
FIDLOCK TEXFL**



black

Page 160

**TEXKF MINI**



black

Page 160

**QUICKSNAP RBU**



black

Page 160

**QUICKSNAP**



black

Page 161

**KF**



black

Page 161

**URB (UNIVERSAL  
FRAME BRACKET)**



black

Page 161

**MOUNTING STRAPS**



black

Page 161

**ORYDE  
ST 2250**



black

Page 162

**ORYDE  
ST 2200**



black

Page 162

**ORYDE  
ST 2085**



black

Page 162

**ORYDE  
ST 2100**



black

Page 163

**BASICO  
ST 5200**



black

Page 163

**ST 5950 2.0**



black

Page 163



### Bracket SH B

Our new SHB bracket makes transport of shackle locks less of a pain. Attaching the lock in the bracket is quick and easy. Any U-lock with a shackle diameter of 12-14mm can be fastened regardless of shackle form.

Ref. No.	EAN	Version	Weight g	Carrier	Box Qty
Bracket SH B	4003318 67899 8		150	for 540, 470, 460	1



#### TECHNICAL DATA

- For transporting most U-locks with a shackle thickness 12-14mm
- Suitable for round and square shackle profile
- Allows the transport of the lock in different places on the bike
- Can be mounted vertically or horizontally
- Suitable for ABUS U-lock 540, 470, 460 and 640
- Push operation is quick & intuitive
- Fits frames tubes with 20-35mm diameter

## USKF



### OPERATION AND USE

- Transport of U-shackle locks
- Mounting on round frames with a diameter of 18-70 mm
- Plastic bracket with rubber inlays for secure mounting
- Convenient one-hand operation
- Easy and quick mounting

Ref. No.	EAN 4003318	Version	Weight g	Carrier	Box Qty
USKF	86143 7		65	for 64/46/47/770A/540/460/470/640	1

## EaZY KF™



### OPERATION AND USE

- Transport of U-shackle locks
- Mounting on round frames with a diameter of 28 - 36 mm
- Screws in two lengths included
- Plastic bracket for fitting with rubber inlays for secure hold
- Index marks on the bracket to simplify subsequent mountings
- Convenient one-hand operation
- Very quick mounting
- Patented design

Ref. No.	EAN 4003318	Version	Weight g	Carrier	Box Qty
EaZy KF	45342 7		95	for 64/61/54/51/47/540/470/460/770A	1
Shackle Clamp 11 mm	45344 1	∅ 11 mm	22	for 61/64 EaZy KF	1
Shackle Clamp 12 mm	45347 2	∅ 12 mm	24	for 460/470	1
Shackle Clamp 13 mm	45343 4	∅ 13 mm	26	for 540/770A	1
Shackle Clamp 13 mm	45346 5	∅ 13 mm	28	for 51/501	1

## USH 540 / 470 / 460 / 420 / 410 / 440A



### OPERATION AND USE

- Transport of U-shackle locks
- Mounting on round frames with a diameter of 15 - 35 mm
- Plastic bracket for mounting
- Mounting within the frame or at the side possible

Ref. No.	EAN 4003318	Version	Weight g	Carrier	Box Qty
USH 540	18576 2		150	for 540	1
USH 460/470/32	18578 6		120	for 460 / 470	1
USH 420	18573 1		144	for 420	1
USH 410	22351 8		46	for 410	1
USH Tex 440	87553 3		96	for 440A	1



## GH 50



### OPERATION AND USE

- For transport of U-shackle locks on frame racks and carriers
- Mounting on the side of the rack
- Plastic bracket for mounting

Ref. No.	EAN 4003318	Version	Weight g	Carrier	Box Qty
GH50	00904 4		196	for 64, 51, 47, 46, 470, 460, 32	1

## UGH 02



### OPERATION AND USE

- For transport of locks on frame racks and carriers
- Mounting on the rack stays with a diameter of 5 - 16.5 mm
- Universal solution for all common racks
- Simple and time saving mounting

Ref. No.	EAN 4003318	Version	Weight g	Carrier	Box Qty
UGH 02	26624 9		80	for 950, 970, 1025, 1050, 8200, 8220, 7200, 7220	1

## SHACKLE CLAMP



### OPERATION AND USE

- Accessory for the transport in a TUBUS LOCC U-shackle lock carrier, TexKF Twin or RBKF Twin

Ref. No.	EAN 4003318	Version	Weight g	Carrier	Box Qty
Shackle Clamp 11mm	25580 9	Ø 11 mm	22	for 64	1
Shackle Clamp 12mm	25604 2	Ø 12 mm	21	for 46, 47, 460, 470, 640	1
Shackle Clamp 13mm	27348 3	Ø 13 mm	30	for 540, 770A	1

## BRACKET SADDLEFIX SH SF



### OPERATION AND USE

- Universal adapter for space-saving attachment of various BORDO locks to the stays of the saddle
- The desired BORDO can be fixed to the adapter together with the corresponding holder
- A rain cap as splash and weather protection for the BORDO is included in delivery

Ref. No.	EAN 4003318	Version	Weight g	Carrier	Box Qty
Bracket SH SF	67866 0	with Rain Cap	121	for SH 5700C/80, SH 5700K/80, SH 6000C/90, SH 6000K/90, SH 6500/85	3

## BRACKET SH 6500A SMARTX™



### OPERATION AND USE

- Easy transport for BORDO 6500A SmartX
- Simple and toolless mounting due to practical mounting strap
- The lock can be easily removed forwards
- Perfect for small framed bikes

Ref. No.	EAN 4003318	Version	Weight g	Carrier	Box Qty
Bracket SH 6500A/110 SmartX	63488 8		148	for 6500A/110	1

## BRACKET SH FL



### OPERATION AND USE

- For easy transport of the BORDO 6000/90, 6100/90 or 6000A/90
- Easy and super fast magnetic mounting to the Fidlock TWIST bike base
- Low space requirement, as the lock can be removed frontally
- The BORDO 6000/90 and 6100/90 are also available individually without holder

Ref. No.	EAN 4003318	Version	Weight g	Carrier	Box Qty
Bracket SH FL	88886 1		160	for 6000/90, 6100/90, 6000A/90, 6000K/90, 6000C/90, 6000KA/90	3

## BRACKET SH 6500/85



### OPERATION AND USE

- Easy transport for BORDO™ 6500, 6500 BIG and 6510
- Simple and toolless mounting due to practical mounting strap
- The lock can be easily removed forwards
- Perfect for small framed bikes
- Optional fitting to frame water bottle cage mounts

Ref. No.	EAN 4003318	Version	Weight g	Carrier	Box Qty
Bracket SH 6500/85	61557 3		152	for 6500/85	3

## BRACKET SH 6500K/90



### OPERATION AND USE

- Easy transport for BORDO 6500KA/90 and 6500K/90
- Simple and toolless mounting due to practical mounting strap
- The lock can be easily removed forwards
- Perfect for small framed bikes

Ref. No.	EAN 4003318	Version	Weight g	Carrier	Box Qty
Bracket SH 6500K/90	69051 8		195	for 6500KA/90, 6500K/90	3

## BRACKET SH 6500/110



### OPERATION AND USE

- Easy transport for BORDO 6500/110
- Simple and toolless mounting due to practical mounting strap
- The lock can be easily removed forwards
- Perfect for small framed bikes
- Should not be fitted to frame water bottle cage mounts

Ref. No.	EAN 4003318	Version	Weight g	Carrier	Box Qty
Bracket SH 6500/110	61556 6		172	for 6500/110	3

## BRACKET SH 6000



### OPERATION AND USE

- Easy transport for BORDO 6000K, 6000KA, 6000C, 6000, 6000A and 6100
- Simple and toolless mounting due to practical mounting strap
- The lock can be easily removed forwards
- Perfect for small framed bikes
- Optional fitting to frame water bottle cage mounts

Ref. No.	EAN 4003318	Version	Weight g	Carrier	Box Qty
Bracket SH 6000/90	61543 6		115	for 6000/90, 6000K/90, 6000KA/90 und 6000C/90, 6000A/90, 6100/90	3

## BRACKET SH 6000 BORDO™ BIG



### OPERATION AND USE

- Easy transport for BORDO 6000 Big, 6000K Big, 6000KA Big and 6000A Big
- Simple and toolless mounting due to practical mounting strap
- The lock can be easily removed forwards
- Perfect for small framed bikes
- Optional fitting to frame water bottle cage mounts

Ref. No.	EAN 4003318	Version	Weight g	Carrier	Box Qty
Bracket SH 6000/120	61564 1		132	for 6000/120, 6000K/120, 6000KA/120, 6000A/120	3

## BRACKET SH 5700/80



### OPERATION AND USE

- Easy transport for BORDO 5700K and 5700C
- Simple and toolless mounting due to practical mounting strap
- The lock can be easily removed forwards
- Perfect for small framed bikes
- Fitting on nearly every part of the frame possible, the lock can be easily removed sideways
- Optional fitting to frame water bottle cage mounts

Ref. No.	EAN 4003318	Version	Weight g	Carrier	Box Qty
Bracket SH 5700/80	61566		114	for 5700K/80 und 5700C/80	3

## BRACKET SH 5700K/100



### OPERATION AND USE

- Easy transport for BORDO 5700K/100
- Simple and toolless mounting due to practical mounting strap
- The lock can be easily removed forwards
- Perfect for small framed bikes

Ref. No.	EAN 4003318	Version	Weight g	Carrier	Box Qty
Bracket SH 5700K/100	61571 9		114	for 5700/100	3

## BRACKET SH 6055 BORDO™ LITE



### OPERATION AND USE

- Easy transport for BORDO 6055 Lite and Lite Mini (Key and Combo version)
- Simple and toolless mounting due to practical mounting strap
- The lock can be easily removed forwards
- Perfect for small framed bikes
- Optional fitting to frame water bottle cage mounts

Ref. No.	EAN 4003318	Version	Weight g	Carrier	Box Qty
Bracket SH 6055	61572 6		60	for 6055K/60, 6055K/85, 6055C/60 and 6055C/85	3

## BRACKET SELLE ROYAL



### OPERATION AND USE

- Easy transport for BORDO 6055 Lite and Lite Mini (Key and Combo version)
- Easy mounting underneath Selle Royal saddles
- Perfect for road bike use

Ref. No.	EAN 4003318	Version	Weight g	Carrier	Box Qty
Bracket SR 6055	63151 1		64	for 6055K/60, 6055K/85, 6055C/60 and 6055C/85	1

## BAG ST 6500 BORDO XPLUS™



### OPERATION AND USE

- Flexible mounting with non-slip velcro straps or screws for the bottle holder device
- Easy transport thanks to practical holder
- Suitable for BORDO 6500/85

Ref. No.	EAN 4003318	Version	Weight g	Carrier	Box Qty
ST 6500/85 black	55325 7		165	replacement bag	1

## BAG ST 6000 BORDO XPLUS™



### OPERATION AND USE

- Flexible mounting with non-slip velcro straps or screws for the bottle holder device
- Easy transport thanks to practical holder
- Suitable for BORDO 6000/90 und 6100/90

Ref. No.	EAN 4003318	Version	Weight g	Carrier	Box Qty
ST 6000/90 black	54297 8		125	replacement bag	1

## BAG ST 6000 BORDO™ BIG



### OPERATION AND USE

- Flexible mounting with non-slip velcro straps or screws for the bottle holder device
- Easy transport thanks to practical holder
- Suitable for BORDO 6000/120

Ref. No.	EAN 4003318	Version	Weight g	Carrier	Box Qty
ST 6000/120 black	55327 1		160	replacement bag	1

## BAG ST 5700 UGRIP BORDO™



### OPERATION AND USE

- Transport bag with latching mechanism and comfortable one-hand-operation
- Flexible mounting with non-slip velcro straps or screws for the bottle holder device
- Easy transport thanks to practical holder
- Suitable for BORDO 5700K/80

Ref. No.	EAN 4003318	Version	Weight g	Carrier	Box Qty
ST 5700/80 uGrip BORDO	11284 3		103	replacement bag	1

## BAG ST 6050 BORDO™ LITE



### OPERATION AND USE

- Flexible mounting with non-slip velcro straps or screws for the bottle holder device
- Easy transport thanks to practical holder
- Suitable for BORDO 6050 und 6150

Ref. No.	EAN 4003318	Version	Weight g	Carrier	Box Qty
ST 6050/85	52909 2		105	replacement bag	1

## IVERA RBU



### OPERATION AND USE

- Transport of chain, cable and Steel-o-flex locks of the Ivera series
- For mounting on round and non-round frame profiles with a diameter of 15 - 45 mm or for practical mounting on the seat clamp
- Easy mounting with a metal sleeve or LL bracket

Ref. No.	EAN 4003318	Version	Weight g	Carrier	Box Qty
Bracket IVERA RBU	58497 8		125	for 7200, 7210, 7220 IVERA	1

## CHAIN BAG ST 2012



### OPERATION AND USE

- Bag designed for the protected transport of lock-chain-combinations
- Flexible mounting with non-slip velcro straps or screws at the bottle holder device
- 2 mm strong Neoprene to keep the content cool or warm
- Strengthened inner-plate for easy mounting

Ref. No.	EAN 4003318	Version	Weight g	Carrier	Box Qty
ST 2012 Chain Bag	58496 1		188	transportation bag: 0,6 Liter	1

## ST 5850/5650/4960



### OPERATION AND USE

- Bag for protected transport of frame locks and accessories
- Convenient attachment to the luggage carrier

Ref. No.	EAN 4003318	Version	Weight g	Carrier	Box Qty
ST 5850/5650/4960	48647 0		100	transportation bag 160 mm / 250 mm / 50 mm	1

## BRACKET SNAP CAGE



### OPERATION AND USE

- Transport of Steel-0-Flex, cable- and coil cable locks
- Enables transporting the lock on the seat post, on the frame and on the rack stays
- With a diameter of 15 - 55 mm
- Simple mounting without tools

Ref. No.	EAN 4003318	Version	Weight g	Carrier	Box Qty
SCMU 4K/5K	20080 9		40	for 4508, 5510K, 5412K	12
SCMU 4C/5C	20111 0		40	for 4508C, 5412C, 5510C	12
SCMU 6K	20079 3		40	for 6415K, 6512K, 6615K	12
SCMU 6C	20113 4		40	for 6415C, 6512C, 6615C	12



## SCLL



### OPERATION AND USE

- Transport of cable, coil cable and Steel-0-Flex locks
- Mounting on all common seat post bolts (diameter 5-8 mm)
- Easy mounting

Ref. No.	EAN 4003318	Version	Weight g	Carrier	Box Qty
Bracket SCLL 4K/5K	87982 1		47	for 4508K, 510K, 5412K	12
Bracket SCLL 4C/5C	87981 4		47	for 4508C, 5412C, 5510C	12
Bracket SCLL 6K	87984 5		47	for 6415K, 6512K, 6615K	12
Bracket SCLL 6C	87983 8		47	for 6415C, 6512C, 6615C	12

## BRACKET SELLE ROYAL



### OPERATION AND USE

- Easy mounting
- Compatible with Selle Royal ICS

Ref. No.	EAN 4003318	Version	Weight g	Carrier	Box Qty
Bracket SR 5C	63485 7		45	for 4508C, 5412C, 5510C	1
Bracket SR 5K	63484 0		45	for 4508K, 5510K, 5412K	1
Bracket SR 6C	63487 1		45	for 6415C, 6512C, 6615C	1
Bracket SR 6K	63486 4		45	for 6415K, 6512K, 6615K	1

## BRACKET FIDLOCK FL



### OPERATION AND USE

- Exclusively for the transport of the Phantom 8960, 8950 and 8940
- For the effortless magnetic mounting on and handy removal from the bracket
- Mounting on round and non-round frame profiles with a diameter of 21 - 80 mm
- Flexible textile sleeve for mounting

Ref. No.	EAN 4003318	Version	Weight g	Carrier	Box Qty
Bracket FL	39729 5		61	bracket only	1

## BRACKET FIDLOCK TEXFL



### OPERATION AND USE

- Exclusively for the transport of the Phantom 8960, 8950 and 8940
- For the effortless magnetic mounting on and handy removal from the bracket
- Mounting on round and non-round frame profiles with a diameter of 21 - 80 mm
- Flexible textile sleeve for mounting

Ref. No.	EAN 4003318	Version	Weight g	Carrier	Box Qty
Bracket TexFL	39730 1		77	bracket only	1

## TEXKF MINI



### OPERATION AND USE

- Transport mostly cable, coil cable and Steel-0-Flex locks
- Mounting on round and non-round frame profiles with a diameter of 21 - 80 mm
- Flexible textile sleeve for mounting
- Mounting within the frame or at the side possible
- Simple and time saving mounting

Ref. No.	EAN 4003318	Version	Weight g	Carrier	Box Qty
TexKF Mini	23265 7		70	for 640, 1460, 8950, 1450, 8940	1

## QUICKSNAP RBU



### OPERATION AND USE

- Transport of cable and Steel-0-Flex locks
- Mounting on round and non-round frame profiles with a diameter of 15 - 45 mm
- Flexible metal sleeve for mounting
- Mounting within the frame or at the side possible
- Simple and time saving mounting

Ref. No.	EAN 4003318	Version	Weight g	Carrier	Box Qty
QuickSnap RBU	31487 2		40	for 860, 870	6

## QUICKSNAP



### OPERATION AND USE

- Transport of cable and Steel-0-Flex locks
- Mounting on all common seat post bolts (diameter 5 - 8 mm)
- Simple mounting

Ref. No.	EAN 4003318	Version	Weight g	Carrier	Box Qty
QuickSnap	31488 9		46	for 860, 870	1

## KF



### OPERATION AND USE

- Transport of cable, coil cable and Steel-0-Flex locks
- Mounting on all common seat post bolts (diameter 5 - 8 mm)
- Simple mounting

Ref. No.	EAN 4003318	Version	Weight g	Carrier	Box Qty
KF	12433 4		41,5	for 896, 895, 894, 885, 875, 1350, 1355, 1340, 1440, 1450, 1460	6

## URB (UNIVERSAL FRAME BRACKET)



### OPERATION AND USE

- Accessory for transporting locks with the LL carrier
- Enables transporting the lock on the seat post or on the frame (diameter 25 - 35 mm)

Ref. No.	EAN 4003318	Version	Weight g	Carrier	Box Qty
URB	23312 8	Ø 25 - 35 mm	30	for locks with LL holder device	12

## MOUNTING STRAPS



### OPERATION AND USE

- Mounting of frame locks to the bike frame

Ref. No.	EAN 4003318	Version	Weight g	Carrier	Box Qty
Mounting straps	56240 2		42	for all ABUS frame locks	1

## ORYDE ST 2250



### OPERATION AND USE

- Frame bag for every day and leisure use

### TECHNICAL DATA

- 1.8 litres stowing capacity
- Water-repellent and robust materials 420D and Scotch Rip 58
- Stable shape
- Reflective applications
- Practical interior design with key hook
- Large main compartment

Ref. No.	EAN	Capacity l	Width mm	Height mm	Depth mm	Version	Box Qty
ST 2250	08469 0	1,8	235	195	50	Velco Straps	1

## ORYDE ST 2200



### OPERATION AND USE

- Frame bag for every day and leisure use

### TECHNICAL DATA

- 1.2 litres stowing capacity
- Water-repellent and robust materials 420D and Scotch Rip 58
- Stable shape
- Reflective applications
- Practical interior design with key hook
- Large main compartment

Ref. No.	EAN	Capacity l	Width mm	Height mm	Depth mm	Version	Box Qty
ST 2200	08470 6	1,2	255	100	50	Velco Straps	1

## ORYDE ST 2085



### OPERATION AND USE

- Saddle bag for every day, sport and leisure use

### TECHNICAL DATA

- 0.7 litre stowing capacity
- Water-repellent and robust materials 420D and Scotch Rip 58
- Stable shape
- Reflective applications
- Practical interior design with key hook
- Particularly simple to fill due to ABUS Easy Flap System
- Includes rain cover with reflective logo

Ref. No.	EAN	Capacity l	Width mm	Height mm	Depth mm	Version	Box Qty
ST 2085 KF	08479 9	0,7	75	70	145	KLICKfix®	6

## ORYDE ST 2100



### OPERATION AND USE

- Saddle bag for every day, sport and leisure use

### TECHNICAL DATA

- 1.2 litre stowing capacity
- Water-repellent and robust materials 420D and Scotch Rip 58
- Stable shape
- Reflective applications
- Practical interior design with key hook
- Expandable pullout to increase stowing capacity

Ref. No.	EAN	Capacity l	Width mm	Height mm	Depth mm	Version	Box Qty
ST 2100 KF	08472 0	1,2	80	95	150	KLICKfix®	6

## BASICO ST 5200



### OPERATION AND USE

- Frame bag for every day and leisure use

### TECHNICAL DATA

- 1.2 litres stowing capacity
- Water repellent and robust material
- Practical interior design
- Large main compartment
- Reflective applications

Ref. No.	EAN	Capacity l	Width mm	Height mm	Depth mm	Version	Box Qty
ST 5200	08482 9	1,2	255	110	65	Velco Straps	1

## ST 5950 2.0



### OPERATION AND USE

- Saddle bag for every day, sport and leisure use

### TECHNICAL DATA

- 0.6 litre stowing capacity
- Water repellent and robust material
- Stable shape

Ref. No.	EAN	Capacity l	Width mm	Height mm	Depth mm	Version	Box Qty
ST 5950 2.0	87510 6	0,6	160	85	90	Velco Straps	1

## INDIVIDUAL SOLUTIONS FOR YOUR ABUS BICYCLE LOCKS

Our locks are designed to protect people's belongings. Just the way you want. Different security levels, shapes, colors - our range offers a wide choice for every bike and the preferences of the proud owner.

We have therefore developed a new presentation system to provide you with optimum support in advising your customers and to make it easier for them to find their way around your store.



**WE HELP YOU SELL**

Your needs as a retailer are very close to our hearts. Our new presentation system is therefore designed to reflect the ABUS brand in the best possible way, while giving you the freedom to suit your sales strategy and salesrooms.

**MODULAR STRUCTURE:**

Height, width, product placement, placement in the room, in the corner or on the wall - you decide.

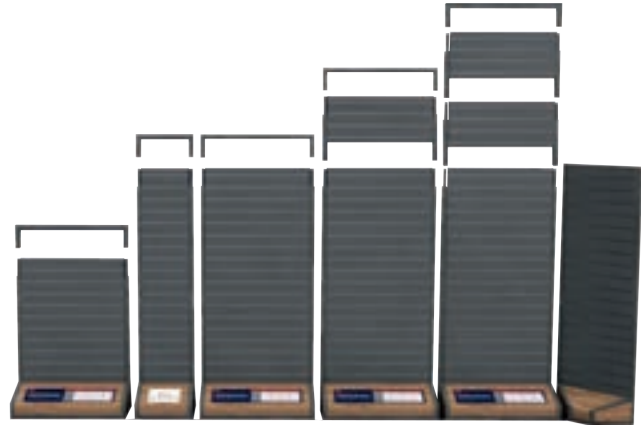

**NUMEROUS ADD-ONS:**

Generate attention, categorize, inform - combine the tools as you need them.

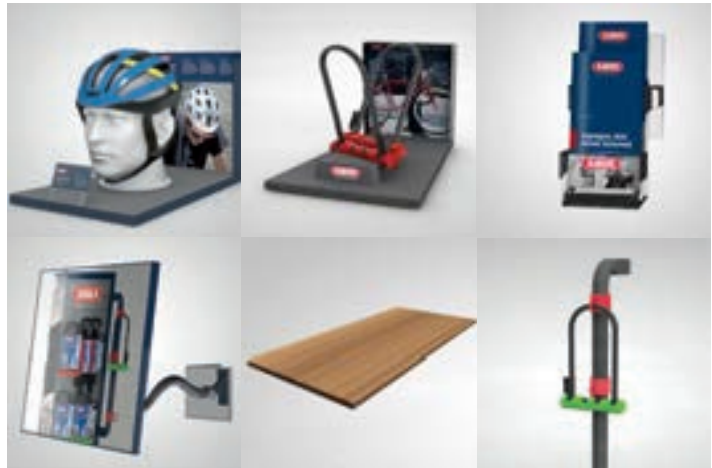

**MODERN DESIGN:**

Metal and wood elements combined in a downscaled "handmade" look - the design concept of your store will not be disrupted.

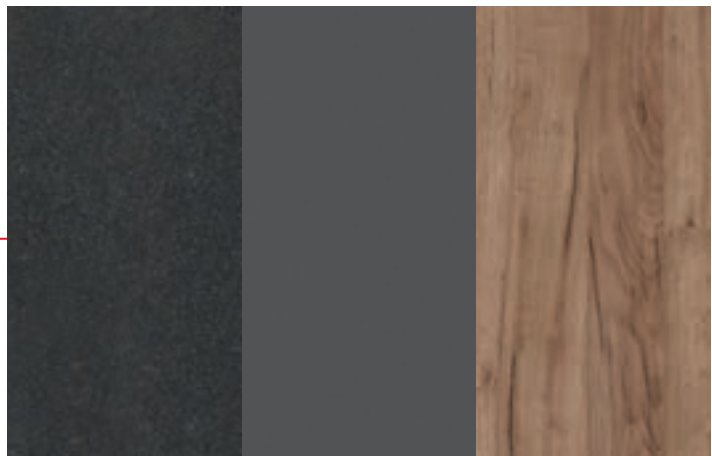

Powder coating  
DB703 fine structure

Graphite Grey  
Kronospan decor  
0162

Tobacco Craft Oak  
Kronospan decor  
K004

**PUT TOGETHER YOUR PERSONAL ABUS SALES AREA NOW!**

# WALLDISPLAY

Make full use of the height and width of your walls to showcase ABUS bike locks.





# WALLDISPLAY DIMENSIONS

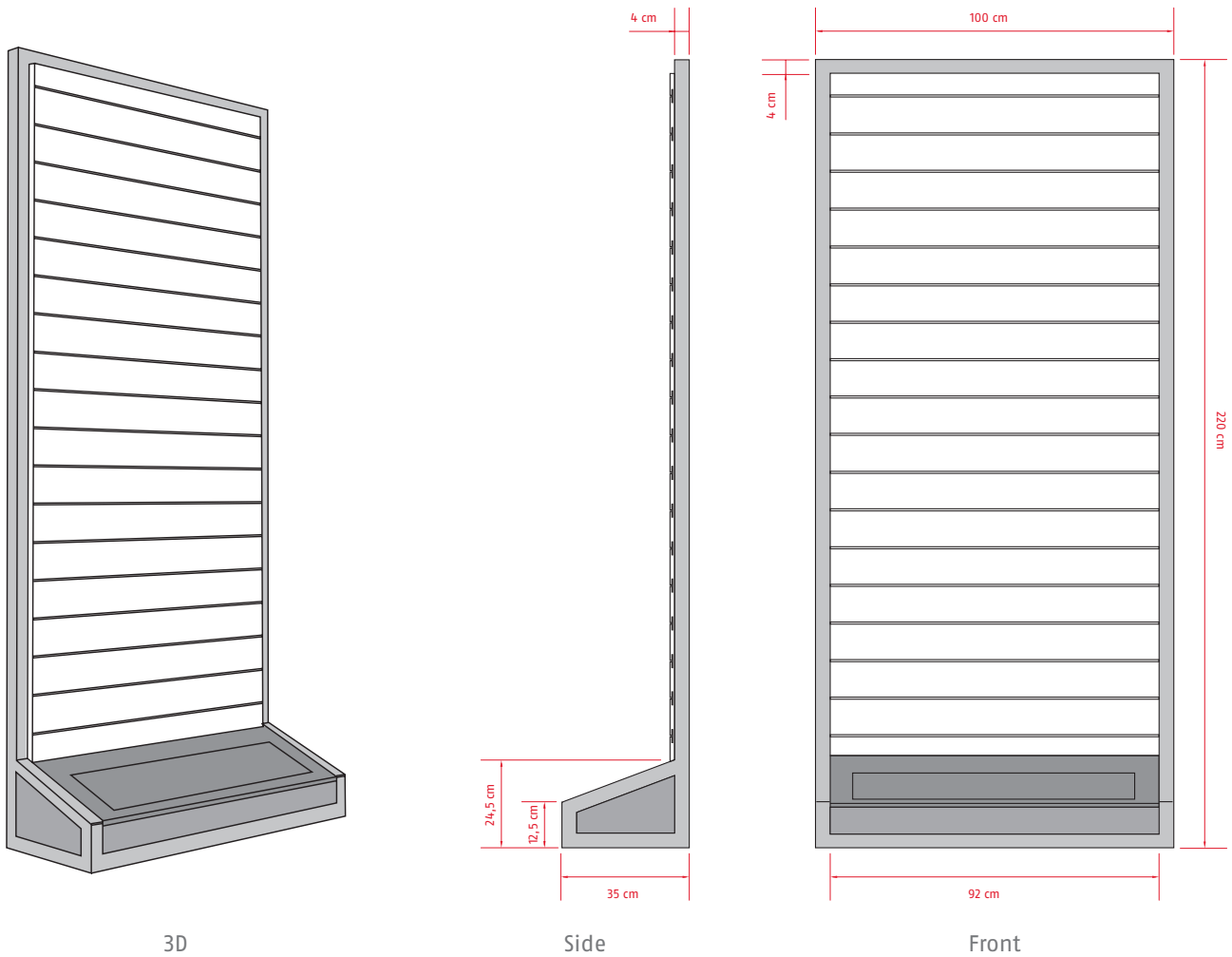

Available in 100 cm or 50 cm width

Height can be extended in 40 cm increments with additional spacers

Slatwall with option for power supply for lighting, etc.



Wood look base with interchangeable inlays

With optional removable lid (can be used as a chute/storage space)

Full-surface image elements possible

## DESIGN EXAMPLES & TIPS

Discover the possible combinations. You can choose and equip your displays to suit your range and premises.



## ADD-ONS

Expand your display with various add-ons for individual placement & product experiences. Over and over again.

### ORIENTATION

Make the ABUS brand widely visible and categorize the bike locks to help your customers find their way around.

### PRODUCT

Combine different hooks, holders and highlighters to present your ABUS range in a space-saving and eye-catching way.

### EXTRAS

Use extras to round out the shopping experience for your customers and speed up the purchase decision.

#### THE FOLLOWING ADD-ONS ARE AVAILABLE FOR BIKE LOCKS:



ABUS Logo one-sided, for hanging  
50 cm

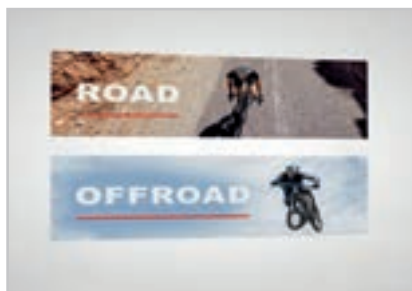

Metal plate & magnetic film  
for category



Backlit frame for pictures

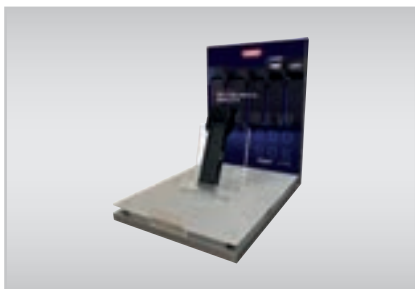

Bordo highlighter attachment



U-lock highlighter attachment



Lock tester, double height

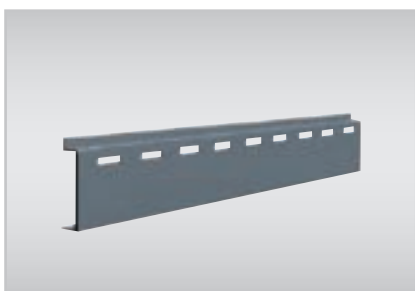

Heavy duty crossbar  
50 cm and 100 cm



Shelf wood  
50 cm and 100 cm



Brochure holder

## FREE-STANDING DISPLAY

Expand and structure the locks category with free-standing displays - for new and promotional products, for example.



# FREE-STANDING DISPLAY DIMENSIONS

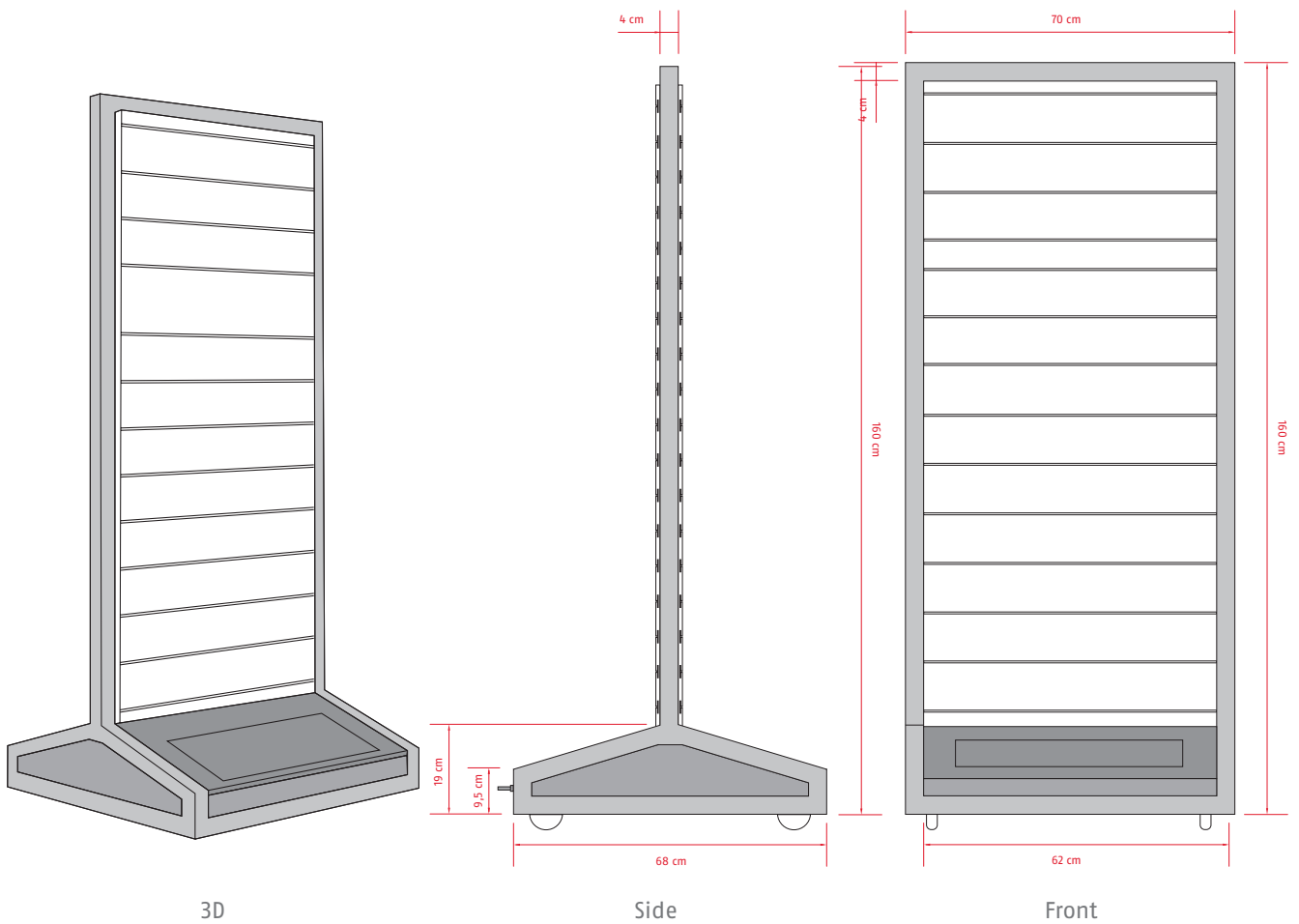

Double-sided use/equipment possible



Height can be extended from 140 cm to 180 cm and 200 cm



Slatwall with option for power supply for lighting, etc.



Wood look base with interchangeable inlays



With optional removable lid (can be used as a chute/storage space)



Full-surface image elements possible

## OTHER DISPLAYS AND ADVERTISING MATERIALS



### BEACH FLAG

Attracts walk-in customers to your store

H: 200 cm



### DISPLAY MD 20

classic display with perforated wall and flexible placeable hooks

Large variant:

H: 224 cm, W: 65 cm, D: 82 cm

Small variant:

H: 156 cm, W: 65 cm, D: 82 cm



**DOORMAT**

Catches dirt from shoes and tires  
Dimensions: W: 120 cm, H: 75 cm

**HOOK**

for your Abus displays  
L: 30 cm



IF YOU ARE INTERESTED, PLEASE DO NOT HESITATE TO CONTACT YOUR SALES REPRESENTATIVE OR OUR OFFICE STAFF



## ONE KEY™ SIMPLE. INDIVIDUAL.

### HAVE CUSTOM BIKE LOCKS MADE - OPERATE EVERYTHING WITH JUST ONE KEY!

A lock for connecting, a frame lock, a padlock, and even a battery lock for e-bikes - if you want to secure your bike properly, you need a lot of locks. That is why we at ABUS, with the ONE KEY system, offer the ability to produce locks for your customers in such a way that they can all be operated with one key. No mess, no looking for keys.

### HOW ONE KEY™ WORKS

It's quite simple. Each ABUS lock has an individual key code with which spare keys or matching "keyed alike" locks can be made - even years after purchase. All that matters is that the locks from ABUS have the same type of cylinder installed.

### HERE'S HOW IT WORKS



The order is conveniently placed via the Partner-Portal.

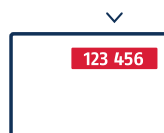

1. Read key code from code card



2. Choose suitable products at your retailer



3. 1 week to manufacture your custom product



4. Pick up at retailer or ship to home





## FAMILIAR FACE – NEW DESIGN

As a manufacturer of cylinders and bicycle locks, ABUS has the unique opportunity on the market to manufacture custom locks so that they can all be operated with one key – or “keyed alike”. It is important that the locks be compatible with each other for this purpose.

So far we have marked our products and campaigns with these icons:

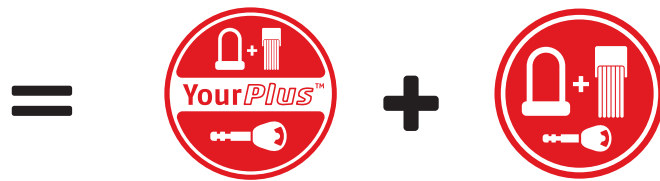

With YourPlus™, we have combined all locks that have a Plus cylinder.

This icon currently indicates that this lock can be keyed alike.

**FROM NOW ON, WE’RE BRINGING EVERYTHING TOGETHER UNDER ONE KEY™ – A CLEAR PROMISE FOR MORE CONVENIENCE.**

## OVERVIEW OF KEYED ALIKE PRODUCTS

### PRODUCTS WITH XPLUS CYLINDER

GRANIT™ Extreme 59  
 GRANIT XPlus™ 540  
 BORDO GRANIT XPlus™ 6500K  
 BORDO GRANIT XPlus™ 6500KA  
 BORDO™ 6000K  
 BORDO™ 6000KA  
 GRANIT City Chain XPlus™ 1060  
 PRO SHIELD™ XPlus 5955  
 SHIELD™ XPlus 5755L

### PRODUCTS WITH PLUS CYLINDER

GRANIT™ Plus 640  
 GRANIT™ Plus 470  
 CityChain™ 1010  
 Steel-0-Chain™ 9809  
 Steel-0-Chain™ 9808

### EC CYLINDER

GRANIT™ 460  
 PHANTOM™ 8960

Surcharge  
 for manufacturing  
 only 10%  
 of the price  
 of the lock



## MAXIMUM CONVENIENCE FOR YOUR CUSTOMERS

- + no chaos, no looking for keys
- + for e-cyclists with battery lock, frame lock, bike lock
- + for families with multiple locks
- + for couples or friends sharing their bike













## KEY SERVICE





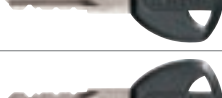
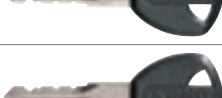









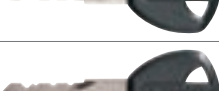

The ABUS key service allows you to order new keys for existing locks.

Just select the required blank, enter the desired coding and the key will be delivered within no time.

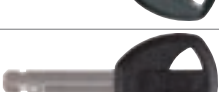
If no key number is available, please send us the illuminated key. We'll produce a replica of the key.



	Cylinder type	EAN-No.:	Item no
	XPlus (illuminated key)	4003318357565	35756 5
	XPlus	4003318246579	24657 9
	Plus (illuminated key)	4003318357572	35757 2
	Plus	4003318062278	06227 8
	8N	4003318816635	81663 5
	6N	4003318709777	70977 7
	T82	4003318561139	56113 9
	T83	4003318844867	84486 7
	F 82	4003318815263	81526 3
	P82	4003318827044	82704 4
	E6	4003318822452	82245 2
	KC 54	4003318815270	81527 0
	ML54	4003318815287	81528 7
	NW52 black	4003318546938	54693 8

	Cylinder type	EAN-No.:	Item no
	NW72 red	4003318547539	54753 9
	PL1	4003318818684	81868 4
	RH 5	4003318100130	10013 0
	RH EC	4003318267666	26766 6
	U72	4003318815294	81529 4
	U73	4003318815300	81530 0
	U74	4003318815317	81531 7
	V61	4003318815324	81532 4
	V62	4003318815348	81534 8
	V63	4003318815331	81533 1
	V64	4003318815355	81535 5
	V65	4003318815362	81536 2
	WD51	4003318398179	39817 9
	Z72	4003318815379	81537 9
	Z73	4003318815386	81538 6
	Z74	4003318815393	81539 3
	ABUS - Voucher for Plus or XPlus	4003318043185	04318 5
	ABUS - Voucher for ABUS other	4003318290015	29001 5

# THE ABUS LEVEL SYSTEM

Finding the right lock for your customer requires a few questions that can help in the selection process. A lock must not only be secure, it must also suit the user.

The questions below can help you figure out what your customer is looking for:

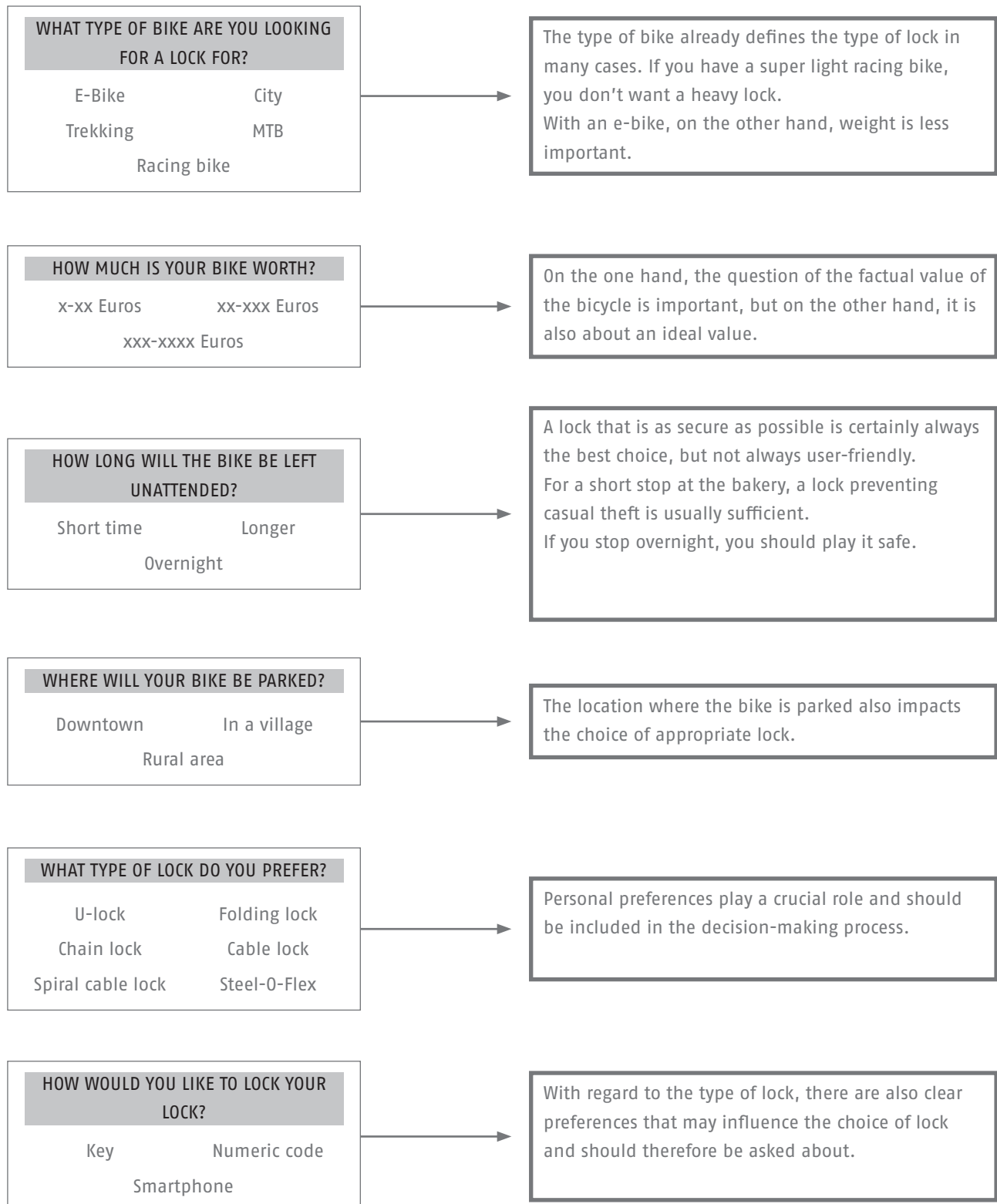

In the sales conversation, you get the best feel for your customer and a sense for what they value.

Many questions are rather soft factors and have an influence on the choice of the lock, but not so much on the choice of the appropriate security level.

The most significant factors impacting the level of safety are certainly the parking location and the amount of time the bike will be left there.

For this, we recommend the following reference:

		WHERE WILL YOUR BIKE BE PARKED?					
		Downtown/major city		Small town/village		Rural area	
HOW LONG WILL THE BIKE BE LEFT UNATTENDED?	Over night						
	Longer						
	Short time						

## ABUS OEM

### **STRONG SERVICE PARTNER, RELIABLE SUPPLIER ABUS AS OEM PARTNER – YOUR FIRST CHOICE**



In the bicycle market, the factors of success are added value, differentiation, flexibility, availability, fast service and high capacity. Suppliers that work with bicycle manufacturers have to meet the corresponding requirements. ABUS does meet them.

As a globally experienced specialist in mobile security, we offer you the best possible support and a high level of reliability. For years, ABUS has been a synonym for security, and has earned a leading position in the bicycle accessory market.

Quality „Made in Germany“ and „Just in time“ deliveries: concentrating on these core competences has made us an important partner for many bicycle manufacturers worldwide. We are also a strong partner on the OEM market, offering a wide selection of frame locks, integrated security solutions, and many individual products. Among others, we offer keyed alike locks and battery cylinders for e-bikes.

Allow us to take advantage of mutual synergy and implement it to our shared success!

Our OEM team looks forward to hearing from you at: [oem@abus.de](mailto:oem@abus.de)

We hope to continue our good cooperation with leading bicycle manufacturers!



# ABUS OEM



GIANT



## CUSTOM SECURITY

Custom security solutions are not just a trend, but also a very convenient way for cyclists to secure their beloved bicycles. Take advantage of our more than 90 years of experience, and set yourself apart from the masses with a customized security solution.



# SPONSORING

At ABUS, we love what we do and give it our best every day.

Just like the athletes of various disciplines with whom we have been working together for years in a spirit of trust. It is a partnership of equals, where everyone contributes their knowledge and can rely on the other. Together, we are getting one step closer to our goal every day: top performance in competition and a sense of security in every situation.

Experience from professional sports flows into product development and brings valuable products for amateur athletes to series production readiness.

We focus on a broad spectrum of athletes and different disciplines.



Road



MTB







Cross Country



Triathlon



Parasport



# INDEX

Ref. No.	Page	Ref. No.	Page
<b>Locks</b>		<b>Brackets and Bags</b>	
20 Diskus®	142	Clutching Strap LH adaptor	161
24IB Diskus®	141	EaZy KF™	150
32 Facilo	26	FL Fidlock	159
59 GRANIT™ Extreme	14 - 15	GH 50	151
64 TITALIUM™	140	IVERA RBU	157
70 & 70IB	141	KF	161
145	139	QuickSnap	161
147TSA	142	QuickSnap RBU	160
205 Combiloop	132	SCLL	159
402	27	SCMU	158
410 Ultra	25	SH 5700/80	154
410 Ultra Combo	25	SH 5700K/100	155
420 Ultimate	22	SH 6000	154
440 Alarm	24	SH 6000 BORDO™ BIG	154
460 GRANIT™	23	SH 6055 BORDO™ Lite	155
470 GRANIT™ Plus	21	SH 6500/110	153
496 TECTIC™	113	SH 6500/85	153
540 GRANIT XPlus™	18 - 19	SH 6500A SmartX™	152
640 GRANIT™ Plus	20	SH 6500K/90	153
767 KeyGarage™	138	Shackle Clamp	151
770A SmartX™	16 - 17	SH B	148 - 149
787 KeyGarage™	136	SH FL	152
787 KeyGarage™ BIG	135	SH SF Saddlefix	152
787 KeyGarage™ BIG LED	135	SR 6055 Selle Royal	155
787 KeyGarage™ LED	136	SR Selle Royal	159
797 KeyGarage™	137	ST 2012 Chain Bag	158
797 KeyGarage™ LED	137	ST 2085 Oryde	162
860 Centuro	81	ST 2100 Oryde	163
950 Steel-0-Flex™	78	ST 2200 Oryde	162
1010 CityChain™	55	ST 2250 Oryde	162
1060 GRANIT CityChain XPlus™	52 - 53	ST 5200 Basico	163
1200 Web	75	ST 5700 uGrip BORDO™	157
1360 Steel-0-Flex™ Tresor	84	ST 5850/5650/4960	158
1385 Tresor	61	ST 5950 2.0	163
1385 Tresor Color	62	ST 6000 BORDO™ BIG	156
1450 Raydo Pro	91	ST 6050 BORDO™ Lite	157
1460 Steel-0-Flex™ Raydo Pro	83	ST 6500 BORDO XPlus™	156
1500 Web	74	ST 6000 BORDO XPlus™	156
1850	133	TexFL Fidlock	160
2504 SportFlex	130 - 131	TexKF Mini	160
3406C	101	UGH 02	151
3406K	101	URB (universal frame bracket)	161
3506C	95	USH 540 / 470 / 460 / 420 / 410 / 440A	150
3506K	95	USKF	150
4408C	100		
4408K	100		
4508C Star	94		
4508K Star	94		
4650S / SL	111		
4650X / XL	110		
4750X / XL PRO AMPARO	108		
4750S / SL PRO AMPARO	109		
4804C Steel-0-Chain™	73		
4804C Steel-0-Chain™ SYMBOLS	72		
4804K Steel-0-Chain™	71		
4960 PRO TECTIC™	112		
5410C Numerino	99		
5410K Primo	99		
5510C Numero	93		
5510K Primo	93		
5700C uGrip BORDO™	45		
5700K uGrip BORDO™	44		
5755L SHIELD XPlus™	107		
5805C Steel-0-Chain™	70		
5805K Steel-0-Chain™	69		
5955 PRO SHIELD XPlus™	106		
6000C BORDO™	42		
6000C BORDO™ LED	43		
6000K BORDO™	39		
6000KA BORDO™	38		
6000PZ BORDO™	40		
6055C BORDO™ Lite	47		
6055K BORDO™ Lite	46		
6210	63		
6412C Tresor	98		
6412K Racer	98		
6500 BORDO GRANIT XPlus™	36		
6500A BORDO SmartX™	32 - 33		
6500K BORDO GRANIT™	37		
6500KA BORDO GRANIT™	34 - 35		
6512C Tresor	92		
6512K Booster	92		
6615C Tresorflex	85		
6615K Microflex	85		
6806K Catena	65		
6806K Catena Color	66		
6806K Catena Neon	65		
6806K Catena Reflective	67		
6806K Classic	68		
7200 IVERA Steel-0-Flex™	80		
7210 IvyTex Chain	59		
7210 IvyTex Chain Color	59		
7220 IVERA Cable	96		
8200 IVEN Steel-0-Flex™	79		
8210 IVEN Chain	58		
8807K Steel-0-Chain™	60		
8950 PHANTOM™	90		
8960 PHANTOM™	82		
9210 IVY Chain	54		
9808 Steel-0-Chain™	57		
9809 Steel-0-Chain™	56		
ADAPTOR CABLE	114		
ADAPTOR CHAIN	114		
ADAPTOR CHAIN IvyTex	115		
AFS625 Fire stop spray	134		
Alarmbox 2.0	124		
Alarmbox RC	125		
Cobra™	133		
Combiflex™	132		
PS88	134		
WA 50	129		
WBA 60	129		
WBA 75 GRANIT™	128		
WBA 100 GRANIT™	128		
WCH	126 - 127		









© ABUS August Bremicker Söhne KG  
[abus.com](http://abus.com)

Altenhofer Weg 25  
 58300 Wetter | Germany  
[mobilesecurity@abus.de](mailto:mobilesecurity@abus.de)  
 + 49 2335 - 634 0

KAT MoSi 2022 Schlösser  
 GB ohne Preise



Due to a policy of continual development, ABUS reserves the right to modify technical details & colours. E&OE ABUS © 2021